



# TEREX

## HI-RANGER

### TM SERIES

# OPERATOR'S MANUAL

This Operator's Manual **MUST BE READ** prior to operating your  
TM SERIES Non-Overcenter Material Handling Aerial Device.

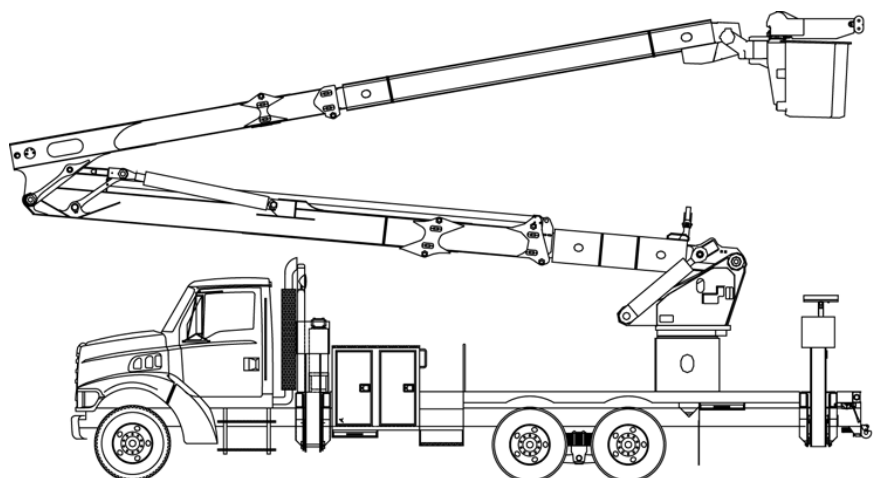

PRINTED IN THE USA  
Original Instructions in English

Terex South Dakota, Inc.  
3140 15th Ave SE  
Watertown, SD 57201

**CALIFORNIA PROPOSITION 65**

 **WARNING** Operating, servicing and maintaining this equipment can expose you to chemicals including engine exhaust, carbon monoxide, phthalates, and lead, which are known to the State of California to cause cancer and birth defects or other reproductive harm. These chemicals can be emitted from or contained in other various parts and systems, fluids and some component wear by-products. To minimize exposure, avoid breathing exhaust, do not idle the engine except as necessary, service your equipment and vehicle in a well-ventilated area and wear gloves or wash your hands frequently when servicing your equipment or vehicle and after operation. For more information go to [www.P65Warnings.ca.gov/passenger-vehicle](http://www.P65Warnings.ca.gov/passenger-vehicle).

Breathing diesel engine exhaust exposes you to chemicals known to the State of California to cause cancer and birth defects or other reproductive harm.

- Always start and operate the engine in a well-ventilated area.
- If in an enclosed area, vent the exhaust to the outside.
- Do not modify or tamper with the exhaust system.
- Do not idle the engine except as necessary.

For more information go to [www.P65warnings.ca.gov/diesel](http://www.P65warnings.ca.gov/diesel).



# TABLE OF CONTENTS

**INTRODUCTION** . . . . . - I

OWNERS, USERS AND OPERATORS . . . . . - I

    PRODUCT IDENTIFICATION . . . . . - I

    INTENDED USE . . . . . - I

    UNAUTHORIZED USE . . . . . - II

    BULLETIN DISTRIBUTION AND COMPLIANCE . . . . . - II

    CONTACTING THE MANUFACTURER . . . . . - II

    TRANSFER OF MACHINE OWNERSHIP . . . . . - II

**SAFETY** . . . . . - III

    HAZARD CLASSIFICATION SYSTEM . . . . . - III

    PROPERTY DAMAGE MESSAGES . . . . . - III

BEFORE OPERATION . . . . . - VI

DURING OPERATION . . . . . - VII

ELECTRICAL HAZARDS . . . . . - VIII

ACCESSORIES . . . . . - IX

MATERIAL HANDLING . . . . . - IX

TRAVELING . . . . . - X

MAINTENANCE . . . . . - XI

OVERVIEW OF POTENTIAL HAZARDS AND SYMBOLS . . . . . - XI

**SAFETY RELATED DECALS** . . . . . - XIV

**WHAT IS INSULATED AND NOT INSULATED** . . . . . - XXVI

UPPER BOOM RATING . . . . . - XXVI

WHAT IS INSULATED . . . . . - XXVII

ELECTRICAL INSULATION . . . . . - XXIX

PREVENTION OF ELECTROCUTION . . . . . - XXX

OPERATION ON OR NEAR ENERGIZED CONDUCTOR . . . . . - XXX

**SECTION 1** . . . . . 1 - 1

**OPERATION GUIDELINES** . . . . . 1 - 1

    NOMENCLATURE . . . . . 1 - 1

    CAB CONTROL OPERATION . . . . . 1 - 2

        MASTER CONTROL . . . . . 1 - 2

        ENGINE STOP/START (OPTIONAL) . . . . . 1 - 2

        POWER TAKE-OFF (OPTIONAL) . . . . . 1 - 2

    CONTROLS BELOW ROTATION . . . . . 1 - 4

    OPERATOR CONTROLS AND DESCRIPTIONS . . . . . 1 - 6

    UPPER CONTROLS . . . . . 1 - 8

        SINGLE STICK . . . . . 1 - 8

    LOWER CONTROLS . . . . . 1 - 13

        TOP CONTROL AND OPTION SHUT OFF . . . . . 1 - 14

        LOWER CONTROL FUNCTIONS . . . . . 1 - 14

    ACCESSORIES . . . . . 1 - 18

        ENGINE STOP/START CONTROL (OPTIONAL) . . . . . 1 - 18

        TWO-SPEED THROTTLE CONTROL (OPTIONAL) . . . . . 1 - 18

        AUXILIARY LET DOWN POWER CONTROL (OPTIONAL) . . . . . 1 - 18

        MANUAL LET DOWN SYSTEM . . . . . 1 - 19

        HYDRAULIC TOOLS (OPTIONAL) . . . . . 1 - 24

    PLATFORM TILT . . . . . 1 - 25

    PLATFORM LEVELING (WITHOUT GENERATOR) . . . . . 1 - 26

    PLATFORM LEVELING (WITH GENERATOR) . . . . . 1 - 27



PLATFORM ROTATOR (OPTIONAL) . . . . . 1 - 28

JIB & WINCH OPERATION (OPTIONAL) . . . . . 1 - 29

    JIB ROTATION . . . . . 1 - 30

    MANUAL JIB EXTENSION . . . . . 1 - 30

    HYDRAULIC JIB EXTENSION (OPTIONAL) . . . . . 1 - 31

    DETERMINING LIFT CAPACITIES . . . . . 1 - 31

    AVOID TRAPPED LOOPS . . . . . 1 - 32

LOWER BOOM LIFTING EYE MATERIAL HANDLING (OPTIONAL) . . . . . 1 - 33

PERSONNEL AND TRAINING . . . . . 1 - 34

PRE-OPERATION . . . . . 1 - 35

    DAILY PRE-OPERATION CHECKS . . . . . 1 - 35

    JOB SITE SURVEY . . . . . 1 - 35

    OPERATING TEMPERATURE RANGE . . . . . 1 - 36

    WIND SPEED . . . . . 1 - 36

    JOB SITE SETUP . . . . . 1 - 37

    SETTING THE OUTRIGGERS . . . . . 1 - 38

    SETTING UP ON A SOFT SURFACE . . . . . 1 - 41

    SETTING UP FOR OPERATION ON SNOW AND ICE . . . . . 1 - 41

    OUTRIGGER INTERLOCK . . . . . 1 - 41

    STABILITY . . . . . 1 - 42

OPERATION . . . . . 1 - 43

    BOOM OPERATION . . . . . 1 - 43

    UNSTORE THE BOOM . . . . . 1 - 44

    AERIAL OPERATION . . . . . 1 - 45

    ENTERING THE PLATFORM . . . . . 1 - 45

EMERGENCY OPERATION . . . . . 1 - 48

    POWER LINE CONTACT ON GROUND . . . . . 1 - 48

    TOP CONTROL SHUT-OFF . . . . . 1 - 50

    AUXILIARY LET DOWN POWER (OPTIONAL) . . . . . 1 - 51

    MANUAL LET DOWN SYSTEM . . . . . 1 - 51

    MANUAL ROTATION . . . . . 1 - 51

HYDRAULIC LINE FAILURE . . . . . 1 - 52

    ENGINE FAILURE . . . . . 1 - 54

    HYDRAULIC PUMP FAILURE . . . . . 1 - 54

    CONTROL VALVE FAILURE . . . . . 1 - 54

OPERATIONAL LIMITATIONS . . . . . 1 - 55

    PLATFORM LEVELING SYSTEM . . . . . 1 - 55

    PLATFORM LEVELING SYSTEM WITHOUT GENERATOR . . . . . 1 - 55

    PLATFORM LEVELING SYSTEM WITH GENERATOR . . . . . 1 - 56

    LIMIT SYSTEM (OPERATIONAL RANGE) . . . . . 1 - 57

    UNITS WITH LIMITING VALVE MOUNTED INSIDE THE LOWER BOOM . . . . . 1 - 58

    UNITS WITH LIMITING VALVE MOUNTED OUTSIDE THE LOWER BOOM . . . . . 1 - 58

    USE OF CATEGORY A UNITS . . . . . 1 - 58

FALL ARREST . . . . . 1 - 59

RESPONSE TO A FALL . . . . . 1 - 59

FOLDING FOR TRAVEL . . . . . 1 - 60

LEAVING THE JOB SITE . . . . . 1 - 60





TM SERIES

**SECTION 2 .....2-1**  
**MAINTENANCE GUIDELINES .....2-1**  
    PREVENTATIVE MAINTENANCE .....2-1  
        MAINTENANCE PROCEDURE .....2-1  
        ADJUSTMENTS AND REPAIRS .....2-1  
        LUBRICATION .....2-2  
        GENERAL INFORMATION .....2-2  
    FREQUENT AND PERIODIC INSPECTION INTERVALS .....2-3  
        DAILY .....2-3  
        30 DAYS (120 HOURS) .....2-3  
        90 DAYS (360 HOURS) .....2-3  
        180 DAYS (720 HOURS) .....2-4  
        12 MONTHS (1,050 HOURS) .....2-4  
        5 YEARS .....2-4  
    OPERATIONAL TESTS .....2-5  
        SPEED TESTS .....2-5  
        CONTROL SYSTEM .....2-5  
        ELECTRICAL TESTS .....2-5  
        POST EVENT INSPECTION AND TEST .....2-5  
    LUBRICATION CHART .....2-6  
    WINCH ROPE INSPECTION .....2-7  
    DAILY ROPE INSPECTION .....2-8  
    HOOK INSPECTION .....2-8  
    STORAGE PROCEDURE .....2-9

**APPENDIX - A ..... A - 1**  
    OSHA EXCERPTS: (CLEARANCE DISTANCE) ..... A - 2  
    STANDARD HAND SIGNALS ..... A - 4

**APPENDIX - B ..... B - 1**  
    RESPONSIBILITIES (ANSI A92.2-2021) ..... B - 1  
        DEALER, INSTALLER, AND SERVICE ENTITIES RESPONSIBILITIES (SECTION 7) ..... B - 1  
        OWNER RESPONSIBILITIES (SECTION 8) ..... B - 2  
        USER RESPONSIBILITIES (SECTION 9) ..... B - 5  
        OPERATOR RESPONSIBILITIES (SECTION 10) ..... B - 6  
        RESPONSIBILITIES OF LESSORS OR LESSEES (SECTION 11) ..... B - 9  
        RESPONSIBILITIES OF BROKER (SECTION 12) ..... B - 10  
    SURVEY OF JOB SITE ..... B - 11





# INTRODUCTION

## OWNERS, USERS AND OPERATORS

Thank you for choosing Terex South Dakota, Inc. equipment for your application. User safety is our number one priority and this is best achieved by our joint efforts.

As equipment users and operators, you make a major contribution to safety if you:

1. Comply with OSHA, federal, state, ANSI, local and your company regulations.
2. Read, understand and follow the instructions in this manual and other manuals supplied with this vehicle.
3. Only allow trained operators, directed by informed and knowledgeable supervision, to run the unit.

If there is anything in this manual that is not clear or you believe should be added, please send your comments to:

Manager of Publications  
 Terex South Dakota, Inc.  
 3140 15th Ave SE  
 Watertown, South Dakota 57201

You may also contact us by phone at: (605) 882-4000



**This is the safety alert symbol. It is used in this manual to alert you to potential personal injury hazards. Obey all safety messages that follow this symbol to avoid possible injury or death.**

This manual contains important information on the safe use of your Terex South Dakota, Inc. equipment. Your failure to read, understand and follow all safety rules, warnings and instructions will unnecessarily expose you and others to dangerous situations. For your safety and the safety of those around you, you **must** operate your Terex South Dakota, Inc. equipment as instructed in this manual.

This manual shall be stored on the vehicle for access by the operator. The Operators manual is required to be stored on the vehicle by ANSI and OSHA regulations. This manual, along with the AEM Aerial Devices Safety Manual and ANSI A92.2 Manual of Responsibilities for Dealers, Owners, Users, Operators, Lessors and Lessees should be considered a permanent part of your machine and should remain with the machine at all times.

## PRODUCT IDENTIFICATION

The serial number is located on the ID plaque. It may be located on the turntable, pedestal or lower boom, depending on options and features. The serial number of the vehicle (VIN) will be different than the serial number for the Aerial Device. Please refer to the Aerial Device serial number when contacting Terex South Dakota, Inc. for service and parts information. Refer to the ID plaque for capacity and dielectric information.

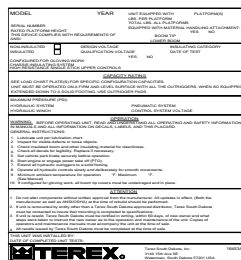

## INTENDED USE

This machine is a tool intended to be used by trained and qualified operators to lift personnel, along with tools to an aerial work site within the rated platform capacity. If equipped with material handling features it may be used to lift material only within its rated capacity. Use of this product in any other way is prohibited and contrary to its intended use.



**UNAUTHORIZED USE**

Secure the vehicle to prevent persons who are not authorized to operate the vehicle and unit. Examples include removing the keys, securing tools and materials, and locking compartments.

**BULLETIN DISTRIBUTION AND COMPLIANCE**

It is the owners responsibility to comply with all bulletins issued by Terex South Dakota, Inc. or the vehicle manufacturer. Safety of product users is of paramount importance to Terex South Dakota, Inc. Various bulletins are used by Terex South Dakota, Inc. to communicate important safety and product information to dealers and machine owners. The information contained in bulletins is tied to specific machines using the machine model number and serial number. Distribution of these bulletins is based on the most current owner on record along with their associated dealer, so it is important to register your machine and keep your contact information up to date and changes in ownership. To ensure safety of personnel and the reliable continued operation of your machine, compliance with the information and actions in the bulletins are mandatory.

	<p><b>Failure to register your machine means you will not receive important information that may impact your safety</b></p>
---	---

**CONTACTING THE MANUFACTURER**

If it is necessary to contact the manufacturer of the machine, supply the unit model number, serial number and your name and contact information. At minimum, the manufacturer should be contacted for:

- Accident Reporting
- Questions regarding product applications and safety
- Standards and regulations compliance information
- Questions regarding product modifications
- Current owner updates, such as changes in machine ownership or changes in your contact information (See Transfer of Machine Ownership below)

**TRANSFER OF MACHINE OWNERSHIP**

If you are not the original owner of this machine, use the following form to provide information on the ownership change.

This information will ensure that you are the owner on record for this machine and you will receive applicable notices and advisories in a timely manner.

You can mail information on changes in ownership to Terex South Dakota, Inc., 3140 15th Ave SE, Watertown, South Dakota 57201 or email the information to: [utilities.warranty@terex.com](mailto:utilities.warranty@terex.com).

REGISTRATION CARD

Terex South Dakota, Inc. Model \_\_\_\_\_ Serial # \_\_\_\_\_

Owner's Name			
Address			
City		State	Zip
Signed		Title	
Email :	Ph #:		Mobile #:
VIN #		Customer Truck #	
Check: ( ) Operation & Maintenance Manual Received.			
Date Placed in Service:			
Previous Owner			
Address			

Note: If Operation & Maintenance Manual was not received, contact Terex South Dakota for copies.



# SAFETY

The operator is the single most important factor for safety when using any piece of equipment. Learn to operate your Terex South Dakota, Inc. equipment in a safe manner.

**NOTE: The best method to protect yourself and others from injury or death is to use common sense. If you are unsure of any operation, do not continue until you are satisfied that it is safe to proceed.**

## HAZARD CLASSIFICATION SYSTEM

This machine contains safety signs to assist in hazard recognition and prevention. The hazard classification system is a multi-tier system used to alert you to potential personal injury hazards. Signal words used with the safety alert symbol indicate a specific level of severity of the potential hazard. To help you recognize important safety information, we have identified **warnings** and **instructions** that directly impact safety.

	<b>This is the safety alert symbol. It is used in this manual to alert you to potential personal injury hazards. Obey all safety messages that follow this symbol to avoid possible injury or death.</b>
---	--

**Danger** is always used with the safety alert symbol and white letter on red background.

	Indicates a hazardous situation that, if not avoided, will result in death or serious injury.
---	---

**Warning** is always used with the safety alert symbol and black letters on orange background.

	Indicates a hazardous situation that, if not avoided, could result in death or serious injury.
---	--

**Caution** is used with the safety alert symbol and black letters on yellow background.

	Indicates a hazardous situation that, if not avoided, could result in minor or moderate injury.
---	---

## PROPERTY DAMAGE MESSAGES

The signal word **NOTICE**, shown without the safety alert symbol, is used to address specific practices or draw attention to supplemental information that is not related to personal injury.

**Notice** does not use the safety alert symbol and text is white italic letters on blue background.

	Indicates information considered important, but not hazard related (e.g., messages related to property damage).
---	---



**In addition to maintenance and operating instructions in this manual, the operator must read and understand all the instructions in the following safety guidelines.**

1. Study all safety messages and apply them on the job.
2. Modifications to this equipment from the original design specifications without written permission from Terex South Dakota, Inc. are strictly forbidden. A modification may compromise the safety of the equipment, subjecting users to serious injury or death. Any such modification will void any remaining warranty.
3. Terex South Dakota, Inc. reserves the right to change, improve, modify or expand features of its equipment at any time. Specifications, model or equipment are subject to change without notice and without incurring any obligations to change, improve, modify or expand features of previously delivered equipment.
4. Comply with manufacturer's instructions and requirements of current OSHA regulations and ANSI standards.
5. This unit is only a tool. The manual does not instruct users how to accomplish tasks assigned by the owner or user. Only training by your employer will instruct the operator and users how to accomplish the assigned task safely.





## GENERAL SAFETY GUIDELINES

1. The use of this Aerial Device is subject to certain potential dangers that cannot be protected against by mechanical means. Only the exercise of intelligence, care, and common sense can eliminate these dangers. It is essential to have competent, careful operators who are physically and mentally fit, and thoroughly trained in the safe operation of this Aerial Device. Learn, understand and practice safe use of all equipment and controls - before operating this Aerial Device.
2. Never exceed the rated load capacity. Know the total weight - including the operator, platform liner, tools, and equipment, and/or other items before entering platform.
3. Conduct a thorough pre-operation visual inspection of the machine and test all functions through their complete cycle before each work shift. Immediately tag and remove from service a damaged or malfunctioning machine.
4. Do not operate this Aerial Device if any interlock or safety device is malfunctioning.
5. Do not bypass or remove any interlock or safety device.
6. Never operate with damaged leveling chain or components.
7. Stop in position if you become aware of any dangerous conditions or hear any unusual noise (such as grinding, cracking or grating) while operating the Aerial Device. Do not move the Aerial Device until the problem has been resolved.
8. Do not operate the Aerial Device if it is not functioning properly or a leak is detected. Repair, document repairs performed and inspect the unit before returning to service.
9. Never operate from the ground controls with personnel in the platform. Operation must be controlled by the platform operator, except in case of an emergency.
10. Keep your Aerial Device control area free of obstructions that may interfere with control operation or physical access to the controls.
11. All ground personnel must be trained in the proper procedures to follow in case of emergency.
12. Do not operate the Aerial Device in an electrical storm.
13. The hydraulic fluid is petroleum based and is flammable.
14. Perform all required inspection and maintenance.

**BEFORE OPERATION**

1. Survey the conditions of the work area. Identify situations such as; soft ground, ditches, drop-offs, holes, debris, overhead obstructions, electrical conductors, and underground utilities.
2. Plan the job (tailgate session) and clear the area of bystanders.
3. Set the vehicle parking brake and chock the wheels.
4. Make certain tire pressures are proper for operation.
5. Visually inspect condition of tires, truck suspension, and torsion bars (if equipped) for any damage.
6. The vehicle must be securely parked and stabilized before any operation is performed. If equipped with outriggers, set all outriggers.
7. If not equipped with outriggers, or only one set of outriggers, the truck tires must equally support the weight of the truck. One tire cannot be in a hole or depression.
8. Do not lower outriggers unless you can see that all ground personnel and bystanders are clear of the outrigger path of movement and its ground contact point. Lower all outriggers onto solid footing.
9. Do not place outriggers on ice as slippage may occur regardless of solid footing. Operation on snow or slippery surfaces requires extra care during set up to ensure Aerial Device and vehicle have sufficient traction to prevent sliding.
10. The Aerial Device has been tested per the stability requirements of ANSI A92.2 and may be operated on firm, flat, non-level surfaces up to a 5 degree slope.
11. Ground and/or barricade the vehicle per OSHA and your company rules.
12. Raise and lower booms through a complete cycle using the lower controls daily, before entering platform, looking for any malfunction or problems. If found, shut down immediately.
13. Perform controls inspection before beginning operation. Do not operate with malfunctioning controls.
14. Barricade or cover any overhead electrical lines that may be a potential contact during operation.
15. Inspect and maintain personal protective equipment.
16. Perform inspections and maintenance as specified in the Maintenance Guidelines.
17. Be sure Operator's Manual is on the vehicle.







## DURING OPERATION

1. Never operate the Aerial Device unless you know the location, function, and operation of all the controls, including emergency and accessory operation.
2. Avoid abrupt starts, stops and reversal of direction. Operate all controls slowly for smooth motion.
3. Keep hands off all moving parts to avoid injury.
4. Operator(s) must wear an OSHA approved fall arrest system with a lanyard attached to an anchor provided.
5. Wear personal protective equipment such as: Insulated hard hat, rubber gloves with leather protectors, and rubber sleeves. Hearing and eye protection, proper boots and suitable clothing may also be required.
6. Do not place the boom in open traffic lanes, stop traffic or barricade lanes to divert traffic from area.
7. Do not allow boom, platform, or any part of the Aerial Device to contact fixed objects.
8. Do not tie off to an adjacent structure, pole, or other equipment.
9. Never exceed rated capacity of platform for men, tools, and liner if equipped.
10. Do not pass tools, equipment, or other objects between the occupant of the platform and other personnel on poles or other platforms.
11. Do not sit or climb onto edge of platform or use planks, ladders, or other devices for a work position. Always stand with both feet on floor of the platform.
12. Do not wear climbers while in the platform.
13. Do not allow ground personnel under the platform work area.
14. Do not operate with platform leveling malfunctioning.
15. Do not move the vehicle with personnel in the platform.
16. Never tie loads to the platform or booms. Always use lifting attachment when it is necessary to lift or lower an object.
17. Do not lift loads with the Aerial Device if it is not equipped with a lifting attachment.
18. High speed should only be used when moving the platform to an aerial job site. Low speed should be used to move into, or within the aerial job site.
19. Low engine speed, if available, should be used when an extended period of time is going to be spent at an aerial job site.
20. Do not use the platform for lifting material. The platform was designed for lifting personnel only.
21. If, when operating the Aerial Device, you become aware of any dangerous condition, unusual operation, or hear any unusual noise, such as grinding, cracking, or grating sounds-STOP-in position. Do not move the Aerial Device until the problem has been diagnosed and resolved with your safety in mind. No matter how long it may take to get help, waiting is better than a serious or fatal accident.
22. Do not adjust outriggers while platform or booms are raised.
23. Do not operate boom controls while standing on the ground or other structures.
24. Operate only in a non-overcenter mode. Follow operational limits of lower boom extension.



## ELECTRICAL HAZARDS

### ELECTRICITY OBEYS NO LAW, BUT ITS OWN.

1. Electricity is an ever-present danger when using an Aerial Device. Follow all OSHA, ANSI, state, federal and company rules and regulations when working on or near energized power lines.
2. Always maintain proper clearance from energized power lines. This Aerial Device cannot protect you from phase-to-phase or phase-to-ground contact, which occurs above the insulating boom section.
  - Allow for platform sag, sway or rocking.
  - If any part of boom-tip, everything beyond band of arrows on boom, contacts an energized conductor, the entire boom-tip, including the control handle(s), must be considered energized.
  - If any part of the boom-tip, everything beyond band of arrows on boom, contacts a grounded object, the entire boom-tip, including the control handle(s), must be considered grounded.
3. The booms and boom operators shall be properly insulated from any contact with electrical conductors; including neutral or ground lines, poles, cross arms and guy wires. Utilize proper insulation such as line covers, rubber blankets and hot line tools.
4. The covers and guards on the boom tip components may provide limited electrical protection. DO NOT contact energized conductors and DO NOT operate without covers. Even if covers are plastic or fiberglass, they are not tested or maintained for dielectric protection. Always cover conductors with line hose and maintain distance from conductive items.
5. Never place booms, platforms, or personnel between energized conductors or between an energized conductor and a grounded conductor without proper cover up.
6. Do not wear clothing that when exposed to flames or electric arcs could increase the extent of injury from such exposure.
7. Never operate the Aerial Device in an electrical environment if the fiberglass boom components are damaged, contaminated by moisture or dirt, or otherwise maintained improperly. A daily inspection and an annual dielectric testing of all fiberglass boom components are necessary to maintain the integrity of the insulation.
8. Never allow ground personnel to come in contact with the Aerial Device, vehicle, or vehicle attachments while in operation near energized power lines.
9. When working on or near energized power lines or equipment, the vehicle must be grounded and/or barricaded and considered as energized.
10. Never rely on the fiberglass platform insulation when in the platform. It may contain small unseen cracks that will allow an electrical path into the platform. Always use a platform liner.
11. Never touch the controls or boom tip area when in the platform without using proper protection (wear rubber gloves) while holding any conductors, neutrals, grounds, or other structures.
12. Ground and neutral conductors are current carrying conductors and must be treated as energized (wear rubber gloves).
13. Wear rubber gloves when handling duplex and triplex wires.
14. All tools, accessories and other objects must be contained within the platform when working on or near energized power lines.
15. Check the boom tip area for any exposed conductive material and do not allow boom tip to come in contact with an energized phase or ground.
16. Do not carry or allow a conductor to touch your body. Handle conductors only with rubber gloves even if grounded.



# TEREX

## TM SERIES

17. All metal components at the boom tip beyond the band of arrows are interconnected. Contact of any part to an energized conductor will energize the entire boom tip, including the controls.
18. Do not attach any metal objects from outside the platform to the inside of the platform. This defeats the purpose of the platform liner.
19. Do not hang metal objects from the platform. It increases the chances of accidental contact.
20. Use only non-metallic tool holders and tool trays.
21. Never use leather work gloves or bare hands on grounded conductors when energized conductors are on the same structure. Wear insulating rubber gloves with leather protectors.
22. Do not lift conductors with the boom tip or platform. Use lifting device with appropriate attachments.
23. Do not bring any conductive object from outside the platform to the inside of the platform. This includes extension cords, guy wires, or conductors. They will eliminate all insulation the machine offers the operator.
24. Do not operate controls while standing on the ground or other structure with booms elevated from stored position. Operating the machine while standing on the ground or other structure could result in electrocution.

**ACCESSORIES**

1. When working from the platform, only use hydraulic tools equipped with orange hoses marked NON-CONDUCTIVE. The hoses must be kept clean and dry and must be inspected periodically.
2. All accessories must be inspected, maintained and operated with the same care and safety rules that apply to the Aerial Device.
3. Do not use hoses having less than 3000 PSI (20.69 MPa) working pressure ratings.
4. Tools selected for use with this Aerial Device should be closed-center type and operate satisfactorily at 2250 PSI (15.51 MPa) and 8 GPM (30 LPM).
5. If this Aerial Device is equipped with a boom lifting eye, the boom position and lifting capacity must not be exceeded.
6. Personnel or load shall not be allowed in the platform when utilizing the boom lifting eye.
7. If this Aerial Device is equipped with platform tilt, an inspection must be made before entering the platform, to insure all locks and pins are properly in place.
8. Do not place booms or platform under trees or limbs while trimming to avoid possible damage or overloading.
9. Do not operate hydraulic hand tools on high speed for an extended period of time without stopping. Continuous operation can cause overheating and possible damage to the hydraulic system.
10. Do not use lower hydraulic tools when platform or booms are near energized lines.

**MATERIAL HANDLING**

1. Use only a synthetic rope for the winch line. Do not use a wire rope.
2. Do not permit personnel to be under loads being lifted.
3. Do not use winch or load line to raise personnel off the ground.
4. Do not allow rope to contact energized power lines. Do not rely on the rope being non-conductive.



5. Keep the winch rope clean and dry.
6. Inspect the winch rope daily. Do not operate with a damaged or frayed rope.
7. Use a sling. Do not use the winch rope as a sling.
8. Use only hooks with a safety latch.
9. Do not overload. The load chart supplied with each Aerial Device gives the machine capacity.
10. Know the weight of the load you are lifting. Do not guess.
11. The jib and winch are designed for vertical loads only. Center the load line directly above the load before lifting.
12. Do not use the jib and winch to pull or string line.
13. Do not pull poles or objects embedded in the ground. It is impossible to know the force applied and will overload the unit.
14. Lifting the load will cause deflection in the Aerial Device. Allow adequate clearance when applying and removing the load.
15. When using the jib as a line lifter, remove the rope from the sheave.
16. Use only approved and tested hot line tools for lifting energized conductors. Clean and inspect all fiberglass on the conductor lifter before use. Dirty or damaged fiberglass may be conductive.
17. If this Aerial Device is equipped with a boom lifting eye, the boom position and lifting capacity must not be exceeded.
18. Personnel or load shall not be allowed in the platform when utilizing the boom lifting eye.



## TRAVELING

1. Never travel with personnel in the platform.
2. Never travel with the booms raised.
3. Fully retract booms and store booms properly in the boom rest. Lower the lower boom fully before lowering upper boom into the rest.
4. Lock boom(s) in place with hold down system.
5. Keep all tools or other items properly stored on the vehicle while traveling. Otherwise, they may fall onto the roadway.
6. Fully retract the outriggers, store outrigger pads, and wheel chocks.
7. Disengage the power take-off to prevent damage.
8. Ensure platform liner is retained during travel with platform cover or clips to prevent loss.
9. Follow the vehicle manufacturer's instructions for operating the vehicle.

**Drive Carefully!**



**TEREX**







## MAINTENANCE

1. Inspect, maintain, and repair this Aerial Device in accordance with the maintenance manual for this device and the maintenance section of this manual.
2. Only authorized and qualified personnel with complete knowledge of this Aerial Device shall be allowed to perform maintenance on this Aerial Device.
3. Never drill holes in the platform.
4. Replace all illegible decals.
5. Do not alter the insulated portion of this Aerial Device. Altering this Aerial Device in any way could reduce its insulating value.
6. Do not search for hydraulic leaks with your hands or any other part of your body.
7. All hoses must meet or exceed the working pressure as stated in the maintenance manual.
8. Only use orange hoses marked NON-CONDUCTIVE for tool hoses, at the boom tip, and areas that bridge the insulation gap.
9. Do not use replacement components that are not equal to the original components.
10. Before doing any work on the hydraulic system, secure the booms and outriggers. Release any hydraulic pressure before attempting repairs or disassembly of hoses, valves, cylinders or any other hydraulic components.
11. Fuel or oil spills may require notification of appropriate Federal, State, or Local officials.
12. Do not operate the Aerial Device after adjustments or repairs until all guards and covers have been reinstalled, trapped air removed from the hydraulic system, safety devices reactivated, and maintenance equipment removed.
13. The subframe, outriggers, and mounting to the vehicle must be inspected following the frequent and periodic inspection intervals for fastener tightness, damaged components and weld inspections.
14. Inspect, maintain, and operate the vehicle and components following the manufacturer’s guidelines.

## OVERVIEW OF POTENTIAL HAZARDS AND SYMBOLS



The Aerial Device is a heavy moving machine capable of extending its reach vertically and horizontally. There are potential hazards associated with the use of this Aerial Device. These hazards will be minimized if the machine is properly inspected, maintained and operated. The operators shall read and understand this manual and be trained to use the machine in an appropriate and safe manner. Should any questions arise concerning the maintenance or operation of the machine contact Terex South Dakota, Inc..

SYMBOL	HAZARD	DESCRIPTION
Alert Symbol 	<b>DANGER:</b> Failure to follow will cause serious injury.	Your safety is involved.

<p>Operators Manual</p> 	<p><b>DANGER:</b> Failure to follow will cause serious injury.</p>	<p>Read and follow operator's manual for safe operation.</p>
<p>Maintenance Manual</p> 	<p><b>DANGER:</b> Failure to follow will cause serious injury.</p>	<p>Follow all inspection and maintenance to prevent failure.</p>
<p>Electrical Contact</p> 	<p><b>DANGER:</b> Will cause Serious Injury Maintain minimum clearance from or Death.</p>	<p>Maintain minimum clearance from overhead high voltage power lines. Refer to "Minimum Clearance for High Voltage Lines" chart in Appendix A. Maintain minimum approach distance as appropriate for your qualifications.</p> <p>Do not dig near underground power lines.</p> <p>Use machine only within its electrical rating. Consult the ID Placard for dielectric rating.</p>
<p>Unit Overturn</p> 	<p><b>WARNING:</b> Can Cause Serious Injury or Death.</p>	<p>Do not travel on steep inclines or crosswise to grades.</p> <p>Do not travel on soft or unstable ground or close to unsupported excavations.</p> <p>All tires should remain on the ground.</p> <p>Set outriggers (if equipped) so indicator remains in green area.</p>
<p>Crushing</p> 	<p><b>WARNING:</b> Will Cause Serious Crushing Injury.</p>	<p>Do not operate outriggers unless you can verify all personnel and obstructions are clear. Operator must watch the outrigger while in motion.</p>
<p>High Pressure Air or Fluid</p> 	<p><b>WARNING:</b> Can Cause Serious Injury or Death.</p>	<p>Relieve pressure on hydraulic and pneumatic systems before loosening hoses or connections. Do not check for leaks with your hand.</p>
<p>Lanyard Attach.</p> 	<p><b>WARNING:</b> Failure to Attach Can Cause Serious Injury or Death.</p>	<p>Attach lanyard to the anchor provided.</p>

TM SERIES

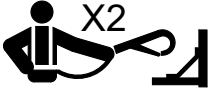
**SAFETY**

<p>Lanyard Attach.</p> 	<p><b>WARNING:</b> Failure to Attach Can Cause Serious Injury or Death.</p>	<p>Attach lanyard to the anchor provided.</p>
<p>Fall</p> 	<p><b>DANGER:</b> Will cause Serious Injury or Death.</p>	<p>Always wear an OSHA approved fall arrest system with lanyard attached to anchor provided.</p>

## SAFETY RELATED DECALS

Safety signs are designed and fitted to the product to warn of possible dangers, and **MUST** be replaced immediately if they become unreadable or lost. If the product is repaired and parts have been replaced on which safety signs were fixed, be sure new safety signs are fitted before the product is put into service. Use mild soap and water to clean safety signs - **DO NOT** use solvent based cleaners, as they may damage the safety sign material.



**Operating this equipment without all safety and control decals in place can be hazardous.**

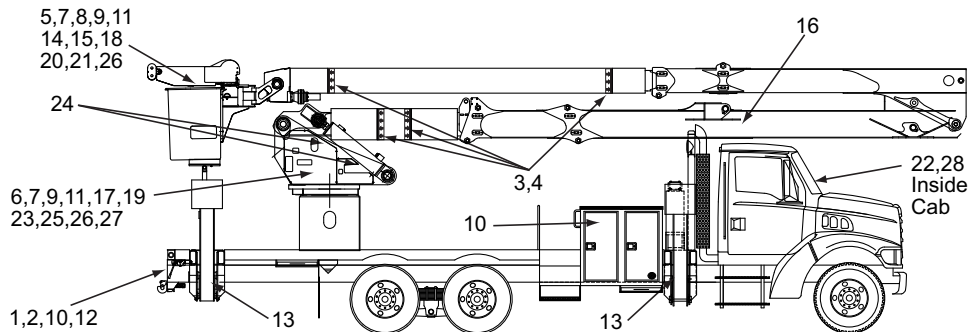

**NOTE: \*Use decal 419265 and 465703 when Aerial Device is not certified in accordance with latest ANSI A92.2 revision or booms are not insulated.**

ITEM #	DECALS	QTY	PART #
1.	CAUTION - TRUCK LEVEL	2	79584
2.	BULLSEYE LEVEL	2	90489
3.	ARROWS	18'	H21503
4.	NOT INSULATED BEYOND ARROWS	10	402236
5.	READ CAREFULLY	1	414590
6.	FAILURE TO OBEY	1	419262
7.	ELECTROCUTION HAZARD	2	419263
8.	FALLING FROM PLATFORM	2	419264
9. *	ELECTROCUTION HAZARD - NOT INSULATED	2	419265
10.	ELECTROCUTION HAZARD - KEEP CLEAR	3	419266
11.	UNTRAINED OPERATOR	2	419267
12.	OUTRIGGER - CRUSHING - DO NOT OPERATE	2	419268
13.	OUTRIGGER - CRUSHING - STAND CLEAR	4	419269
14.	CONDUCTIVE HOSE	2	419270
15.	CONTROLS NOT INSULATED	1	463602
16. *	NOT INSULATED	4	465703
17.	ANSI WARNING	1	468476
18.	OVERTURNING HAZARD	2	475373
	OVERTURNING HAZARD (TM125 ONLY)	2	488127
19.	MAINTENANCE RECORD	1	489119
20.	LANYARD ATTACHMENT, X2 (depending on boom tip option)	1	495440
21.	LANYARD ATTACHMENT, X1 (depending on boom tip option)	1	495441
22.	TRUCK COMPUTER	1	495845
23.	FALL HAZARD - MAINTENANCE	1	495892
24.	PINCH POINT	4	H23451
25.	ESCAPING FLUID UNDER PRESSURE	1	H23877





TM SERIES

26.	PROP 65 OPERATING STATION	2	622232
27.	CAUTION DECAL	1	70191
28.	PROP 65 DRIVER SIDE WINDOW	1	622233

1.



2.

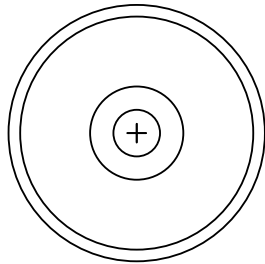

**SAFETY RELATED DECALS**

3. & 4.



5.



6.

**! DANGER**

**FAILURE TO OBEY THE FOLLOWING  
WILL RESULT IN  
DEATH OR SERIOUS INJURY**

- For stationary operation, truck must be securely parked, driveline disengaged, and Aerial Device properly stabilized prior to operation.
- To avoid tip-over, outriggers (when so equipped) must be properly extended on a solid level surface.
- Operate all controls slowly for a smooth platform motion and make sure controls are returned to neutral after desired operation.
- Crew must use proper personal and other protective equipment.
- Never load beyond rated capacity.
- Never operate Aerial Device with personnel under boom or load.
- Never move the truck until the booms and outriggers are in a properly stowed position and secured.
- Refer to the operator's manual for complete instructions. If missing, replace manual.

419262

7.

**! DANGER**

**ELECTROCUTION HAZARD**

**DEATH OR SERIOUS INJURY  
WILL RESULT FROM CONTACT WITH  
OR INADEQUATE CLEARANCE TO  
ELECTRICAL POWER LINES  
AND APPARATUS**

- Maintain safe clearances from electrical power lines in accordance with applicable government regulations. Allow for boom, platform, electrical line and load line sway.
- This machine does not provide protection from contact with or proximity to an electrically charged power line when you are in contact with or in proximity to another power line.

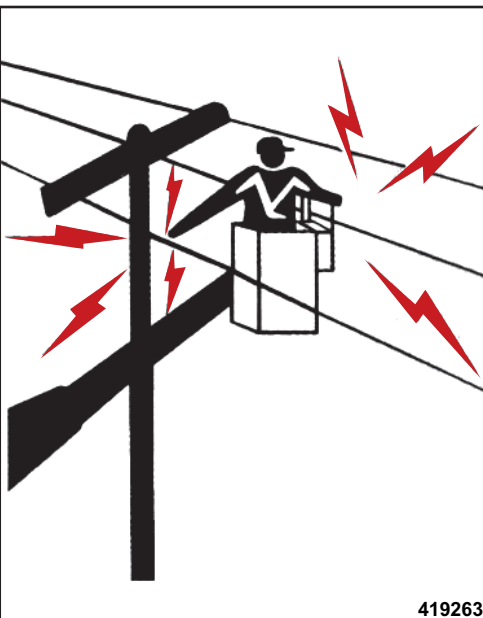

419263

8.

<p><b>! DANGER</b></p>	
<p><b>FALLING FROM PLATFORM WILL RESULT IN DEATH OR SERIOUS INJURY</b></p> <ul style="list-style-type: none"> <li>● Platform personnel must wear an OSHA approved fall protection system with lanyard attached to anchor provided.</li> <li>● Platform doors, if provided, must be securely latched.</li> </ul>	

419264A

9.

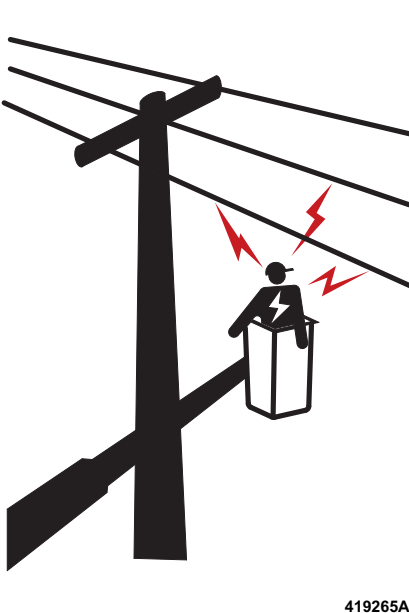
<p><b>! DANGER</b></p>	
<p><b>ELECTROCUTION HAZARD THIS MACHINE IS NOT INSULATED DEATH OR SERIOUS INJURY</b></p> <p>Will result from contact with or inadequate clearance to electrical power lines and apparatus</p> <ul style="list-style-type: none"> <li>● Maintain safe clearance from electrical power lines in accordance with applicable government regulations. Allow for boom, platform, electrical line and load line sway.</li> <li>● This machine does not provide protection from contact with or proximity to an electrically charged power line.</li> <li>● Boom and platform must be kept below all electric power lines.</li> <li>● Do not use for work on electric power lines.</li> </ul>	

419265A

10.

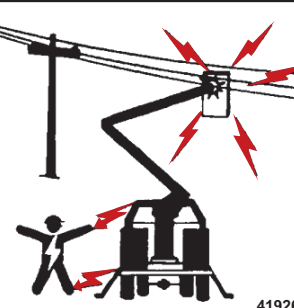
<p><b>! DANGER</b></p>	
<p><b>ELECTROCUTION HAZARD DEATH OR SERIOUS INJURY WILL RESULT FROM CONTACT WITH THIS MACHINE, TRUCK OR TRUCK ATTACHMENTS IF THEY SHOULD BECOME ELECTRICALLY CHARGED.</b></p> <p><b>KEEP CLEAR OF TRUCK AND LOAD</b></p>	

419266



11.



DANGER

AN UNTRAINED OPERATOR  
SUBJECTS HIMSELF AND  
OTHERS TO  
**DEATH OR SERIOUS INJURY**  
YOU MUST NOT OPERATE  
THIS MACHINE UNLESS

- You have been trained in the safe operation of this machine.
- You have read, understand and follow the safety and operating recommendations contained in the machine manufacture's manuals, safety signs attached to equipment, your employer's work rules and applicable government regulations.
- You are sure the machine is operating properly and has been inspected and maintained in accordance with manufacturer's manuals.
- You are sure that all safety signs, guards and other safety features are in place and in proper condition.

419267

12.

DANGER

OUTRIGGER CONTACT  
WILL CAUSE  
**SERIOUS CRUSHING INJURY**

- Do not operate any outrigger unless you or a signal person can see that personnel and obstructions are clear of the outrigger and its contact point.

419268A

13.



DANGER



OUTRIGGER CONTACT WILL CAUSE  
SERIOUS CRUSHING INJURY  
**STAND CLEAR**

419269

14.

DANGER

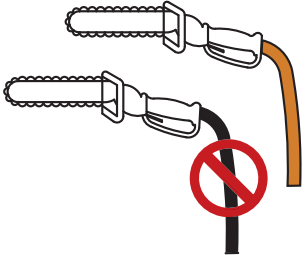

ELECTROCUTION HAZARD  
FIRE HAZARD

USE ONLY ORANGE, NON-CONDUCTIVE HOSE FOR TOOL, PLATFORM AREA, AND INSULATED SECTIONS.

FAILURE TO DO SO MAY CAUSE  
**DEATH OR SERIOUS INJURY.**

419270A

15.

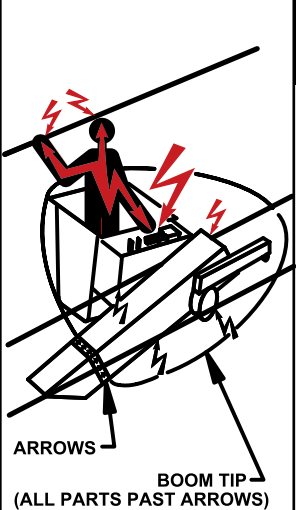

**! DANGER**

**ELECTROCUTION HAZARD**

**CONTROLS ARE NOT INSULATED OR ISOLATED**  
 All metal at boom tip is electrically connected.  
 Operator contact with ANY, live or grounded, line or object while operator touches CONTROLS or BOOM TIP COMPONENTS and boom tip contacts any other line or object can result in

**DEATH OR SERIOUS INJURY**

Comply with OSHA, ANSI, & NESC requirements

- Maintain proper CLEARANCE to all lines and objects
- Wear Personal Protective Equipment: Fall protection; Eye protection; Insulating: gloves, sleeves, and hard hat; & Special clothing
- Cover all lines with insulated line hose or insulating blankets
- DO NOT Depend on machine covers for insulation  
 Plastic or fiberglass covers offer limited electrical insulation.  
 Covers are NOT tested, certified, or maintained as insulating.

ARROWS  
 BOOM TIP  
 (ALL PARTS PAST ARROWS) 463602A

16.

**NOT INSULATED** 465703

17.

**! WARNING**

**FAILURE TO FOLLOW PROPER PROCEDURES**  
 Could Result In  
**DEATH OR SERIOUS INJURY**

If YOU sell, install, offer for use, use, operate or maintain this Aerial Device  
 You MUST COMPLY with the requirements of:  
 American National Standards Institute A92.2,  
 National Electric Safety Code, and OSHA 468476



18.

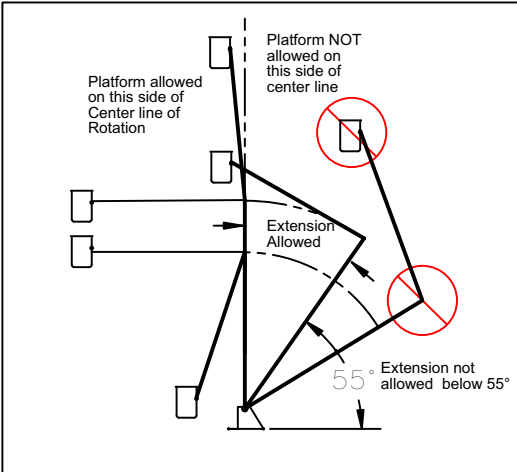

**! DANGER**

**OVERTURNING HAZARD  
DEATH OR SERIOUS INJURY**

May result from operating outside the proper platform & boom positions or improper outrigger setup or truck position

- Platform must remain opposite lower boom hinge pin from lower boom.
- Lower boom can only extend when lower boom is above 55 degree angle.
- Upper boom can be extended at any time.
- All outriggers must be properly set before operation of the booms.
- Truck must be level before operation of the booms.

475373

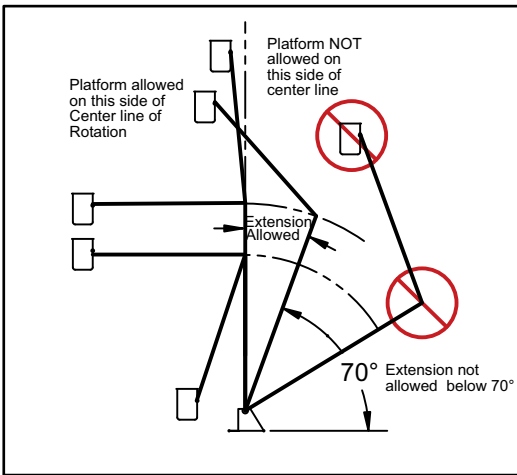

**! DANGER**

**OVERTURNING HAZARD  
DEATH OR SERIOUS INJURY**

May result from operating outside the proper platform & boom positions or improper outrigger setup or truck position

- Platform must remain opposite lower boom hinge pin from lower boom.
- Lower boom can only extend when lower boom is above 70 degree angle.
- Upper boom can be extended at any time.
- All outriggers must be properly set before operation of the booms.
- Truck must be level before operation of the booms.



488127





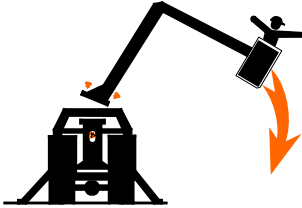

23.

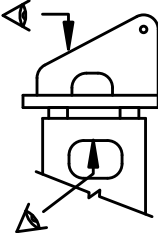
 <b>WARNING</b>	
	
<b>FALL HAZARD</b> FAILURE TO PROPERLY MAINTAIN THIS MACHINE CAN LEAD TO STRUCTURAL FAILURE AND RESULT IN DEATH OR SERIOUS INJURY	
  	<p>Read and follow all inspection and maintenance schedules in the manual(s). Do not operate machine unless all deficiencies are corrected. Proper maintenance and inspection is required for safe and reliable operation.</p> <p>Daily Visual Inspection</p> <ul style="list-style-type: none"><li>- all structural components and welds</li><li>- all fasteners for damage, signs of looseness or missing from required location.</li><li>- damaged or missing covers or guards</li></ul> <p>Check torque on fasteners as required in manual(s). Fasteners include turntable to rotation bearing, pedestal to rotation bearing, cylinder and boom pivot pins and retainers, subframe mounting bolts and leveling components.</p> <p>The Aerial Device or Digger Derrick you are operating must be maintained by a qualified person.</p>
<small>495892A</small>	

24.

**! WARNING**

**PINCH POINT**  
**KEEP HANDS CLEAR**  
**TO AVOID PERSONAL INJURY**

H23451

25.

**! WARNING**



**Escaping fluid under pressure can penetrate skin causing serious injury.**

**Relieve pressure before disconnecting hydraulic lines. Keep away from leaks and pin holes. Use a piece of cardboard or paper to search for leaks. Do not use your hand.**

**Fluid injected into skin must be surgically removed within a few hours by a doctor familiar with this type injury or gangrene will result.**

H23877A

26.

**! WARNING** Cancer and Reproductive Harm -  
[www.P65Warnings.ca.gov](http://www.P65Warnings.ca.gov) 622232B

27.

**! CAUTION**

**TO PREVENT POSSIBLE INTERFERENCE AND AVOID DAMAGE:**

- 1. ROTATE BASKET CAREFULLY TOWARDS BOOM AND CENTER BASKET BEFORE FOLDING OR UNFOLDING BOOM.**
- 2. POSITION JIB PARALLEL TO UPPER BOOM BEFORE STORING IN BOOM REST.**

70191C



# TM SERIES

28.

 **WARNING** Operating, servicing and maintaining this equipment, passenger vehicle or off-highway motor vehicle can expose you to chemicals including engine exhaust, carbon monoxide, phthalates, and lead, which are known to the state of California to cause cancer and birth defects or other reproductive harm. These chemicals can be emitted from or contained in other various parts and systems, fluids and some component wear by-products. To minimize exposure, avoid breathing exhaust, do not idle the engine except as necessary, service your equipment and vehicle in a well-ventilated area and wear gloves or wash your hands frequently when servicing your equipment or vehicle and after operation. For more information go to [www.P65Warnings.ca.gov/passenger-vehicle](http://www.P65Warnings.ca.gov/passenger-vehicle).

Breathing diesel engine exhaust exposes you to chemicals known to the state of California to cause cancer and birth defects or other reproductive harm.

Always start and operate the engine in a well-ventilated area.  
If in an enclosed area, vent the exhaust to the outside.  
Do not modify or tamper with the exhaust system.  
Do not idle the engine except as necessary.  
For more information go to [www.P65Warnings.ca.gov/diesel](http://www.P65Warnings.ca.gov/diesel).

622233A

**SAFETY RELATED DECALS**

# WHAT IS INSULATED AND NOT INSULATED

## UPPER BOOM RATING

The ID plate on your aerial device will indicate if the unit is insulated and the voltage the insulation has been designed and tested to withstand. The manuals also indicate what areas of the machine will provide insulation. Look on the ID plate for the **QUALIFICATION VOLTAGE**. The number in this area is the voltage rating the unit was tested and qualified per ANSI standards. The date of the Manufacturing Qualification test is indicated on the ID plate as the **TEST DATE**.

**Not Insulated or Insulated**  
If the Insulated box is checked, it indicates the booms will provide electrical insulation. If the Not Insulated box is checked, the unit will not provide any dielectric protection.

**Qualification Voltage**  
Maximum Phase to Phase voltage machine can be used on with proper PPE and work procedures.

**ANSI Category**  
Indicates what work unit is capable of performing.

**Date of Manufacturer Test**

MODEL	YEAR	UNIT EQUIPPED WITH LBS: PER PLATFORM	PLATFORM(S)
SERIAL NUMBER		TOTAL LBS. ALL PLATFORMS	
RATED PLATFORM HEIGHT		EQUIPPED WITH MATERIAL HANDLING ATTACHMENT:	
THIS DEVICE COMPLIES WITH REQUIREMENTS OF ANSI:		BOOM TIP	YES
		LOWER BOOM	NO
INSULATED	DESIGN VOLTAGE	INSULATING CATEGORY	DATE OF TEST
INSULATED <input type="checkbox"/>	QUALIFICATION VOLTAGE	YES	NO
CONFIGURED FOR GLOWING WORK: YES NO			
CHASSIS: INSULATING SYSTEM			
HIGH RESISTANCE SINGLE STICK UPPER CONTROLS			
CAPACITY RATING			
SEE LOAD CHART PLATE(S) FOR SPECIFIC CONFIGURATION CAPACITIES.			
UNIT MUST BE OPERATED ON A FIRM AND LEVEL SURFACE WITH ALL THE OUTRIGGERS, WHEN SO EQUIPPED, EXTENDED DOWN TO A SOLID FOOTING, USE OUTRIGGER PADS.			
MAXIMUM PRESSURE (PSI):			
HYDRAULIC SYSTEM		PNEUMATIC SYSTEM	
HYDRAULIC WINCH		CONTROL SYSTEM VOLTAGE	
WARNING: BEFORE OPERATING UNIT, READ AND UNDERSTAND ALL OPERATING AND SAFETY INFORMATION IN MANUALS AND ALL INFORMATION ON DECALS, LABELS, AND THIS PLACARD.		OPERATION	
GENERAL INSTRUCTIONS:			
1. Lubricate and per lubrication chart.			
2. Inspect for visible defects or loose objects.			
3. Check insulated boom and other insulating material for cleanliness.			
4. Check all decals for legibility. Replace if necessary.			
5. Set vehicle park brake securely before operation.			
6. Start engine or engage power take off (PTO).			
7. Extend all hydraulic outriggers to a solid footing.			
8. Operate all hydraulic controls slowly and deliberately for smooth movements.			
9. Minimum ambient temperature for operation: °F Maximum: °F			
(See Manual)			
10. If configured for glowing work, all boom tip covers must be undamaged and in place.			
ATTENTION			
1. Do not alter components without written approval from the manufacturer. All updates in effect. (Both the manufacturer as well as ANSI/OSHA) at the time of rebuild should be performed.			
2. If unit is remounted by entity other than a Terex South Dakota approved distributor, Terex South Dakota must be contacted to insure that mounting is completed to specifications.			
3. If unit is resold, Terex South Dakota must be notified in writing, within 60 days, of new owner and what steps were taken to instruct the new owner as to the operation and maintenance of the unit. Copies of operators and maintenance manuals must accompany the unit at the time of sale.			
4. All recalls issued by Terex South Dakota must be completed at the time of sale.			
THIS UNIT WAS INSTALLED BY:			
DATE OF COMPLETED UNIT TESTS:			
		Terex South Dakota, Inc. 16453AJ	
		3140 15th Ave SE	
		Watertown, South Dakota 57201 USA	

ID PLATE



## WHAT IS INSULATED

The term insulated means separated from other conductive surfaces by a dielectric substance (including air space) offering a high resistance to the passage of current (from OSHA 1926.960).

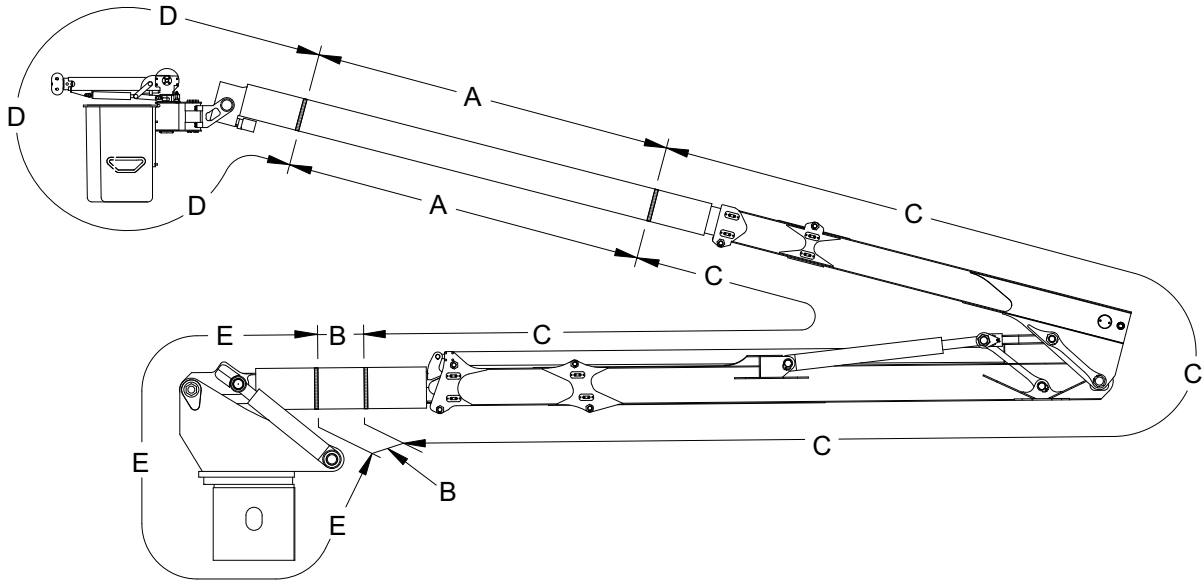

**Area A.** Upper Boom Insulation, provides an insulating area between area D and earth ground when in properly maintained condition.

**Area B.** Lower Boom Insert, provides an insulating area between area C and area E when in properly maintained condition.

**Area C.** Elbow, does not provide insulation. This area contains conductive materials such as cylinders, pins, boom structure, and other metal components. The operator shall not allow any portion of this area to come in contact with an energized phase, ground conductor, or grounded objects. Proper protective devices shall be used on all conductors. Any contact with a ground and phase line or between two-phase conductors will create a hazard.

**Area D.** Boom Tip, does not provide insulation. This area contains conductive materials such as control levers, un-insulated platform(s), platform support shaft, boom-tip structure and other metal components. These objects must be considered connected. The operator shall not allow any portion of this area to come in contact with an energized phase, ground conductor or grounded objects. Proper protective devices shall be used on all conductors. The operator shall not make contact with any portion of this area when working on or near an energized phase, ground or grounded objects, unless wearing proper protective clothing such as rubber gloves and sleeves rated at the voltage of the lines. Any contact with a phase line, a ground and phase or between two-phase conductors will create a hazard. Accidental contact of any portion of area D to an energized conductor will energize the entire area D.

**NOTE: A properly maintained platform liner will only provide protection for those portions of the body or materials entirely within the liner and not in contact with any part of area D.**

**Area E.** Does not provide insulation. This area contains conductive materials such as cylinders, pins, boom structure, turntable, pedestal and other metal components. The operator shall not allow any portion of this area to come in contact with an energized phase, ground, or grounded objects. Proper protective devices shall be used on all conductors. This area is attached to the vehicle and connected trailers, which must be barricaded and/or grounded through an approved ground system when working in the vicinity of energized conductors. Any contact with a phase or between two-phase conductors will create a hazard.

**WHAT IS INSULATED AND NOT INSULATED**

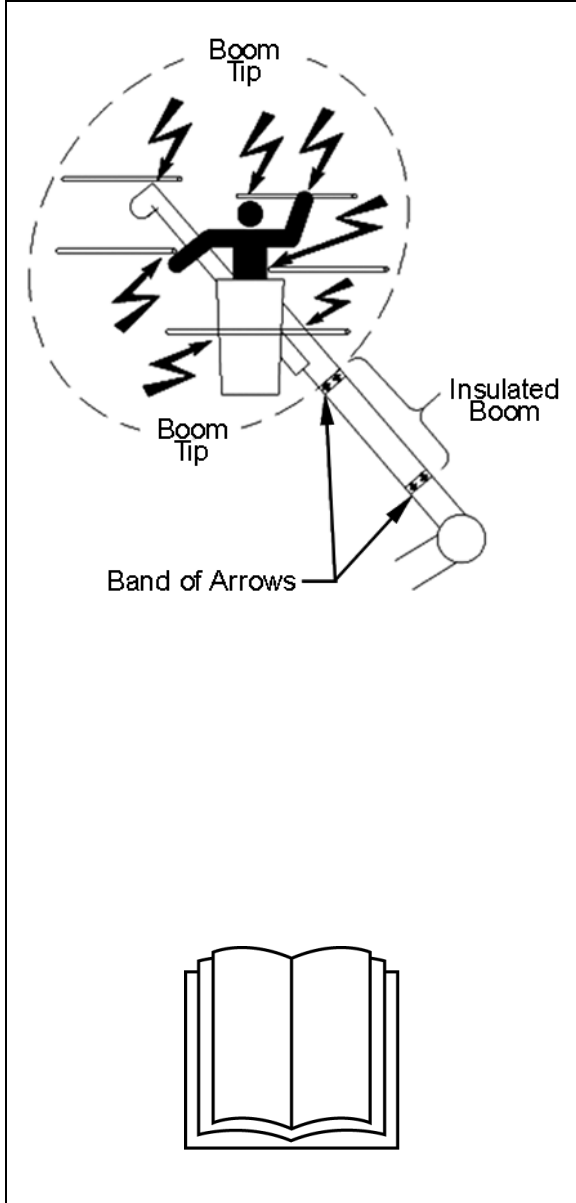



- 

The insulating boom section only prevents current from passing from the band of arrows at the boom tip to the lower band of arrows. All components above and below that area must be considered conductive.
- 

The boom tip is everything past the upper band of arrows. All boom tip components are structurally and electrically connected. Contact with any part of the boom tip will energize the entire boom tip including, jib, winch, and platform support structure.
- 

Death or serious injury to the operator or ground personnel can occur if any part of the boom or boom tip contacts an energized conductor, ground line, grounded line, or OBJECTS. Proper clearance must be maintained.
- 

You must always cover the line and wear rubber gloves with rubber sleeves and an approved hard hat when any part of the Aerial Device is working on or near energized lines or conductors even when working on a grounded line, neutral line, or ground line.
- 

Neutral, static and ground lines are current carrying conductors and require proper handling. Treat them as energized.
- 

You must read the operators manual to fully understand the protection the Aerial Device will give you.



**Anytime the platform occupant(s) contact two items at different potential without proper personnel protective equipment, their body may become a path for electric current, and they may be electrocuted. This includes touching the controls, any tools, or items on the boom tip while also contacting a line or ground.**

## ELECTRICAL INSULATION

Operation on or near energized lines is extremely hazardous unless proper OSHA and ANSI work rules are followed. The operation of this Aerial Device in proximity to high voltage electrical lines involves several hazards to the operator of the Aerial Device, ground personnel and bystanders on the ground. These hazards are as follows:

1. Contact of the operator with a single energized line will allow current to pass through the operator's body to ground by means of an all-metal boom structure, unless the operator is insulated from ground.
2. Contact of the operator with two energized lines or one energized line and a grounded conductor will cause electrocution, even if the operator is insulated from ground by the Aerial Device.

	<b>The fiberglass upper boom, fiberglass lower boom insert and fiberglass platform, including its components, do not protect the platform operator from injury in case of contact between two energized lines, or between an energized line and a grounded conductor.</b>
---	---

	<b>Working around electrical power lines is covered by ANSI and OSHA Regulations. To reduce danger to the operator and ground personnel or bystanders on the ground, understand and follow all rules.</b>
---	---

**IMPORTANT: Only caution and proper work practice on the part of the occupant(s) will protect the occupant(s).**

3. Contact of a metal section of the boom with a wire, below the insulation of the boom, will energize the Aerial Device and the vehicle causing electrocution to ground personnel and bystanders standing on the ground and touching the vehicle.

	<b>Ground personnel should never touch the Aerial Device, the vehicle or an attached trailer while the Aerial Device is in operation near electrical power lines even though the Aerial Device has an insulated boom and lower boom insert.</b>
---	---

	<b>Avoid contact of any metal part or equipment below the insulated section of the lower boom with an electrical power line. Serious injury or death could result.</b>
---	--

4. Contact of the boom with a wire may break the wire or burn the wire in two, which will cause a hazard to ground personnel and bystanders below.

Some protection against Hazard No.1 is furnished by the fiberglass upper boom. When PROPERLY MAINTAINED, the insulated boom protects platform personnel in case they were to contact a SINGLE energized power line within the qualification voltage limit stamped on the nameplate. However, this protection can be nullified by accumulation of dirt and moisture on or in the boom. Operator safety requires a regular electrical testing program.

Some protection against interphase contact, Hazard No. 2, is offered by the platform liner. The platform liner is used for interphase protection of the lower half of the body only. Only caution on the part of platform personnel and use of proper protective equipment will protect the upper half of their body from this hazard. Any conductive object in the platform liner, which protrudes above the liner, will eliminate any protection the liner may offer.

Limited protection of ground personnel against contact of the steel elbow area or lower boom with an energized line, Hazard No. 3, is offered by the insulated lower boom and a proper grounding system. The lower boom insert, like the insulated upper boom, must be regularly tested and cleaned to ensure continued safety. Contact with an energized line below the lower boom insert will energize the vehicle and the ground around the vehicle. Anyone close to the vehicle may be injured. A ground cable to a suitable ground may prevent damage and injury. Ensure ground cables are making good contact with the vehicle and ground rod or neutral and are not coiled on reel or storage hooks. A properly grounded vehicle does not guarantee protection for people on the ground. It's purpose is to engage the line protection, fuse or breakers as quick as possible to limit damage. A lethal voltage may still exist between the vehicle and ground.



There is no protection against Hazard No. 4. Caution must be exercised continually to avoid making contact with an energized line, which, if broken or burned, may drop to the ground and cause injury to ground personnel and any bystanders.

## PREVENTION OF ELECTROCUTION

1. NEVER rely on fiberglass dielectric properties around power lines with moisture present on the platform(s) and booms. If the Aerial Device is stored outdoors, protect the platform(s) and booms from the weather with a cover when not in use. To preserve dielectric properties, fiberglass must be kept clean and dry.
2. REMEMBER, auxiliary equipment, such as electrical cords, communication lines, and conductive tools, that bridge the insulation between the operator and ground, render the insulation useless.
3. REMEMBER your Aerial Device cannot protect you against contact between two-phases, between one phase and a pole or a grounded conductor. Never work between electrical lines unless the proper precautions are observed.
4. DO NOT allow any ground personnel or bystanders to touch the Aerial Device, the vehicle, or an attached trailer while the Aerial Device is in operation near electrical power lines, even if the Aerial Device has an insulated lower boom.
5. Have boom insulation TESTED annually, in accordance with established rules and regulations.
6. CONTROLS are not insulated and are interconnected to all other conductive components at the boom tip. DO NOT contact any conductor or wire while touching controls, unless wearing insulating rubber gloves rated for the voltage.
7. DO NOT depend on plastic covers, fiberglass covers, or guards installed on the Aerial Device for dielectric protection from contact with a line or ground. The covers may provide some protection, but they are not tested to guarantee dielectric strength. Hidden damage, dirt and contamination will make them conductive. Use line covers or blankets when closer than the minimum approach distance.

## OPERATION ON OR NEAR ENERGIZED CONDUCTOR





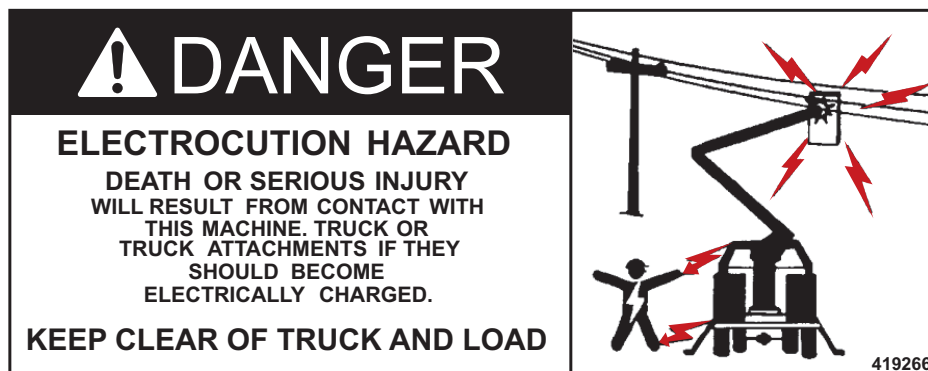

When working ON OR NEAR ENERGIZED CONDUCTORS (either known or suspected), special conditions arise. While the fiberglass upper boom provides a high degree of electrical insulation between the platform and the vehicle, there are several things it WILL NOT DO:

- IT WILL NOT PROVIDE PHASE TO PHASE PROTECTION.
- IT WILL NOT PROVIDE PHASE TO GROUND PROTECTION THROUGH STATIC LINES OR GUY WIRES.
- IT WILL NOT PROTECT THE VEHICLE FROM BEING ENERGIZED IF STEEL BOOMS CONTACT A LOWER LEVEL SECONDARY POWER SOURCE.

The fiberglass boom must be kept clean and dry for this type of work.





	<p>The fiberglass boom and platform liners must be dielectrically tested periodically to insure the insulating properties are being maintained. Do not assume that it is so.</p>
	<p>Ground personnel must be warned to stay away from vehicle in case of accidental boom contact between conductor and metallic portion of boom, which will cause serious injury or death.</p>
	<p>The fiberglass upper boom, fiberglass lower boom insert and fiberglass platform, including its components, do not protect the platform operator from injury in case of contact between two energized lines or between an energized line and a grounded conductor.</p>
	<p>Upper Controls can become energized if any part of the boom-tip past the band of arrows on the boom contacts a conductor. The Aerial Device upper control station has metal parts that are necessary to provide the structural support for the components. These metal parts at the boom-tip are interconnected. The main shaft that supports the platform(s) and controls also support other load carrying options that can be added to the boom-tip.</p>
	<p>Do not depend on Aerial Device covers for insulation. Plastic or fiberglass covers offer limited electrical insulation. Covers are not tested, certified or maintained as insulation.</p>
	<p>All conductors including grounds and neutral lines are current carrying conductors and must be treated as energized unless properly grounded and tested.</p>
	<p>The fiberglass upper and lower boom, in a well maintained condition, provides electrical insulation between the upper boom-tip and the vehicle to ground. This fiberglass will not protect the platform operator if any portion of the boom tip or upper arm control station, including options is brought into contact with an energized or non-energized conductor and the operator is in contact with a different potential, such as grounded non-energized conductor. This type of contact can energize or ground the controls because all components of the upper control station are interconnected. The fiberglass will not provide protection for the operator in phase to phase contact or a phase to ground wire contact above the upper boom insulation. Nor will it protect the vehicle from becoming energized if the steel boom section below the lower boom insert, if so equipped, is brought into contact with an energized conductor. Serious injury or death could result.</p>

**⚠ DANGER**

**READ CAREFULLY**

- OCCUPANTS OF THE BASKETS OF THIS AERIAL DEVICE HAVE ABSOLUTELY NO ELECTRICAL PROTECTION FROM CONTACT BY THE HUMAN BODY WITH TWO ENERGIZED CONDUCTORS OR BETWEEN AN ENERGIZED CONDUCTOR AND A GROUNDED CONDUCTOR.
- It makes no difference if this contact is accidental or deliberate or whether contact is made through metallic parts of the basket, basket support, metal tools or equipment brought into the basket. The insulating components of this aerial device do not offer protection in the event of such contact.
- Proper conductor cover up, insulated sleeves and gloves shall be worn when working near energized lines or equipment.

**DEATH OR SERIOUS INJURY WILL RESULT FROM SUCH CONTACT OR INADEQUATE CLEARANCE**

414590A

**⚠ DANGER**

**ELECTROCUTION HAZARD**

**CONTROLS ARE NOT INSULATED OR ISOLATED**

All metal at boom tip is electrically connected.  
Operator contact with ANY, live or grounded, line or object while operator touches CONTROLS or BOOM TIP COMPONENTS and boom tip contacts any other line or object can result in

**DEATH OR SERIOUS INJURY**

Comply with OSHA, ANSI, & NESC requirements

- Maintain proper CLEARANCE to all lines and objects
- Wear Personal Protective Equipment: Fall protection; Eye protection; Insulating: gloves, sleeves, and hard hat; & Special clothing
- Cover all lines with insulated line hose or insulating blankets
- DO NOT Depend on machine covers for insulation  
Plastic or fiberglass covers offer limited electrical insulation. Covers are NOT tested, certified, or maintained as insulating.

463602A

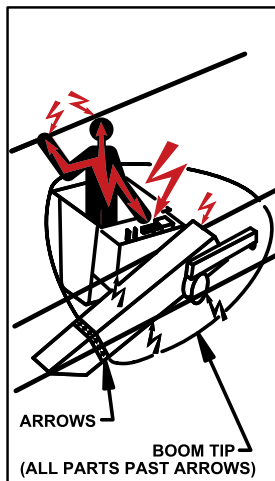

# SECTION 1

## OPERATION GUIDELINES

### NOMENCLATURE

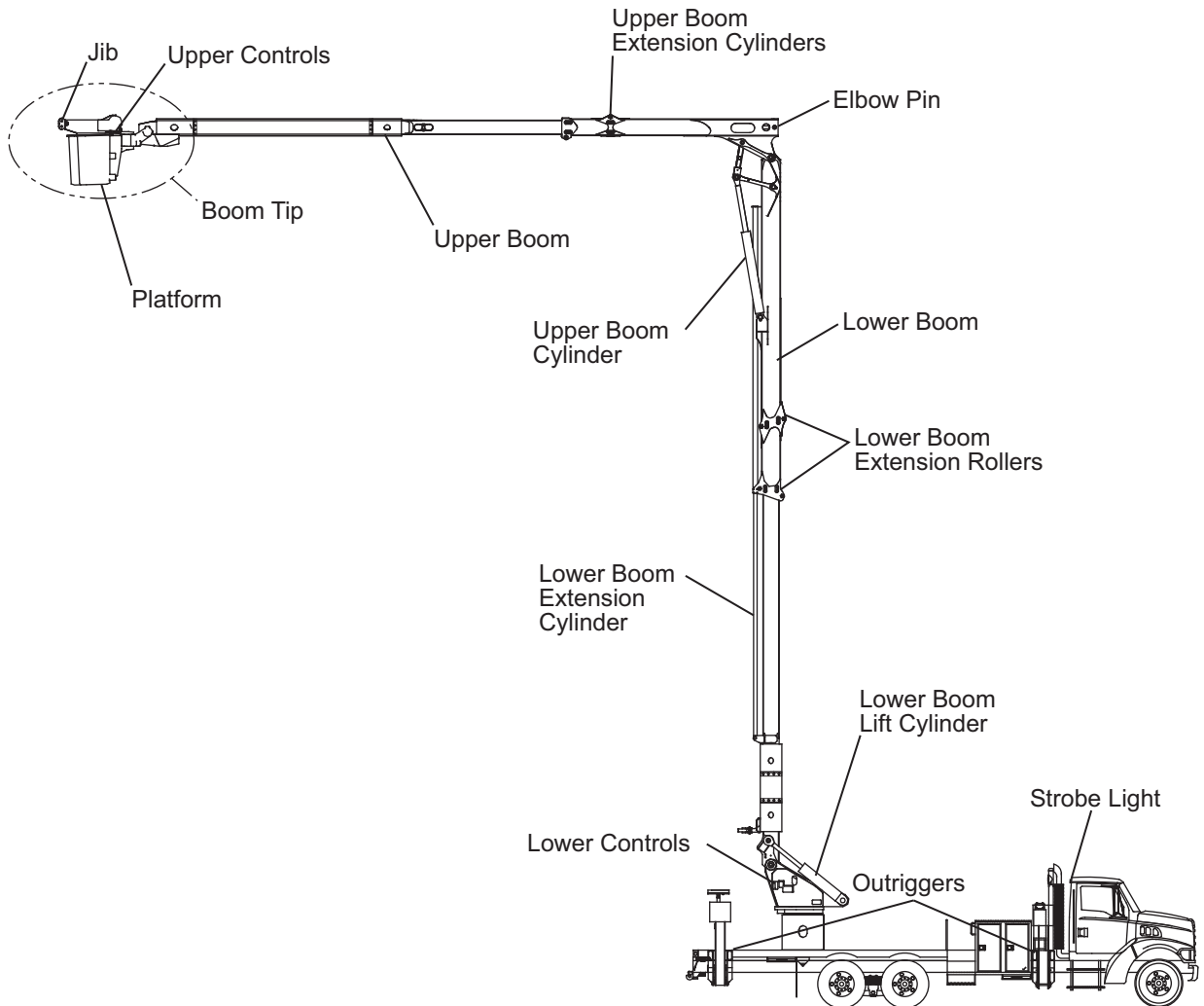

## CAB CONTROL OPERATION

### MASTER CONTROL

The master control is located in the cab of the vehicle and may be a display, switch panel or switch in the dash. The switch is used to energize the engine stop/start system and the throttle control options, which may be located in the cab, at the platform, or on the pedestal. When the light is lit, the switch is energizing these systems. If the unit is not equipped with engine stop/start, two-speed throttle or 12V hydraulic power, it may have only a PTO switch.



CAB CONTROLS

### ENGINE STOP/START (OPTIONAL)

The engine stop/start may be located at the outrigger controls, lower controls, or platform controls depending on options ordered. To start the engine press the button and hold in for a moment until the engine starts, then release. To stop, or shut off, the engine, press the button again.



**Be sure the vehicle transmission is in neutral, the brakes are applied and the wheels are chocked before engaging the PTO or using the engine stop/start.**

**NOTE:** Because of engine emission requirements some engines may not crank immediately when the key or the remote STOP/START buttons are pressed. There may be a delay of several seconds before cranking will begin. Hold the button until the engine cranks.

### POWER TAKE-OFF (OPTIONAL)

The power take-off (PTO) is a gearbox used to transmit power from the vehicle transmission to the hydraulic pump, which provides hydraulic oil for the Aerial Device functions. The power take-off control can be a switch on the dash, for electric control systems, or a “push-pull” knob, (usually mounted on the cab floor) and a red light mounted in the vehicle dashboard. When lit, this red (PTO) dash light indicates the PTO is activated and serves to remind the operator not to drive the vehicle with the PTO engaged.



**Driving with the PTO engaged may damage both the pump and the PTO.**

To engage the power take-off properly, refer to the PTO manufacturer's operating instructions and be sure the manufacturer's operating decals are posted in the cab with the PTO controls.

**NOTE:** Typical controls are illustrated. Each installation may be unique depending on configuration and options.



**CAB CONTROLS OPERATION**

Master Power	See 1 (shown below)	<p>Push to activate the remote electrical systems. A light indicates when the system is active. This light may be separate or built into the switch panel or display.</p> <p>Push again to deactivate the remote electrical systems. The indicator light will turn off.</p> <p>Master Power may also be the PTO switch if a separate PTO switch is not installed.</p>
PTO	See 2 (shown below)	<p>Push to engage the PTO. A light indicates when the PTO is engaged. This light may be separate or built into the switch panel or display.</p> <p>Push again to deactivate the PTO. The indicator light will turn off when the PTO is disengaged.</p>
Warning Light	See 3 (shown below)	Controls vehicle warning light such as strobe lights.
Accessories switches	See 4 (shown below)	Optional accessories may be controlled by the remaining switches.

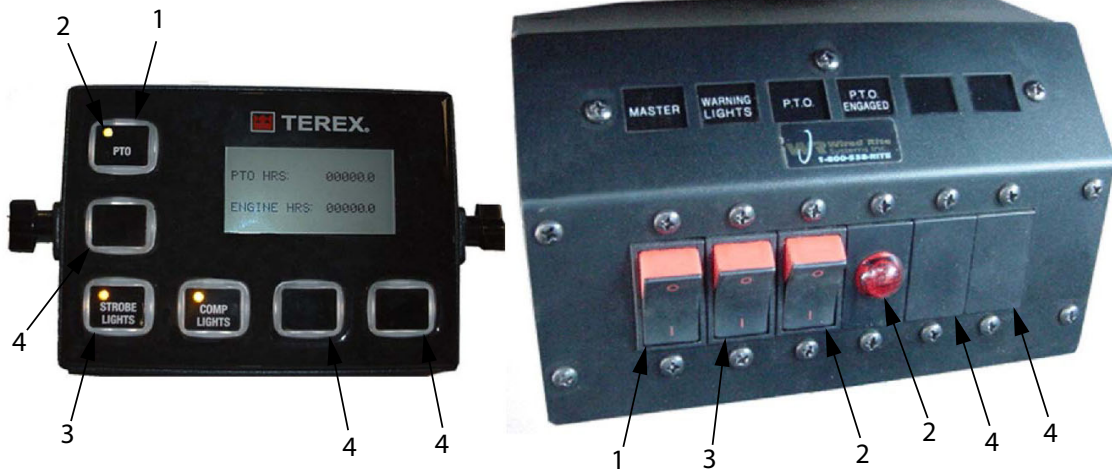

## CONTROLS BELOW ROTATION

These controls are usually mounted at the rear of the vehicle chassis. The controls may include outriggers, hydraulic tools, control selector, engine stop/start, two-speed throttle, and auxiliary let down power. The controls shown are generic. The actual location and functions will vary depending on the purchasers requirements and options ordered. Refer to the control decals on unit for proper operation.

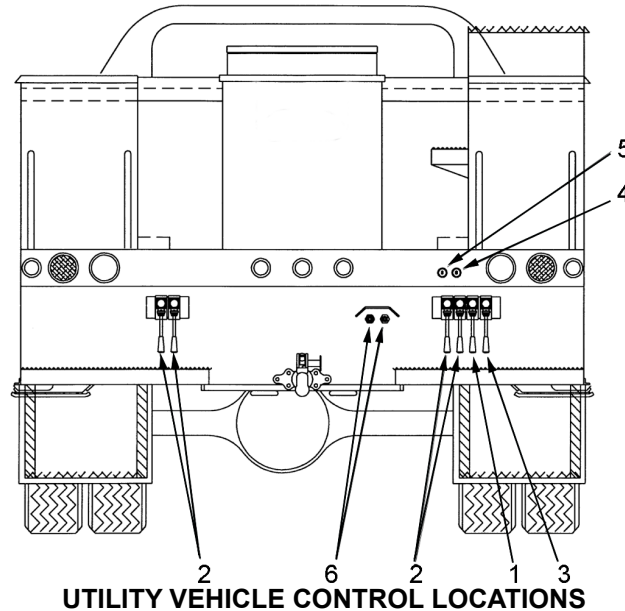





ITEM	CONTROL	DESCRIPTION
1.	Selector (Optional)	A selector valve that allows operation of boom functions when in the "UP" position and operation of the outriggers when in the "DOWN" position.   <b>The Selector will function as an emergency stop by taking oil flow away from the active controls.</b>
2.	Outrigger Controls (Optional)	Allows extending and retracting of outriggers.
3.	Hydraulic Tools (Optional)	Directs oil flow to the tool when connected to the quick couplers.
4.	Engine Stop/Start (Optional)	Allows operator to stop and start engine.
5.	Two-Speed Throttle (Optional)	Two-speed throttle provides two engine speeds, low and high, with engine running. Low speed is engine idle.
	Auxiliary Let Down Power (Optional)	Auxiliary let down power provides hydraulic power to lower and stow the Aerial Device in the event of a prime power source failure.
6.	Hydraulic tool couplers (Optional)	Quick couplers for hydraulic tool connection.

 **The decals are an integral part of this Aerial Device. If the decals are illegible, they must be replaced.**

 **Always operate controls slowly and deliberately for smooth movements. Rough handling is never excusable and may cause damage to the Aerial Device and endanger the operator.**

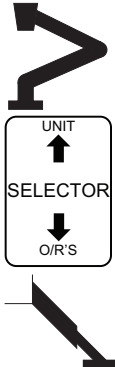
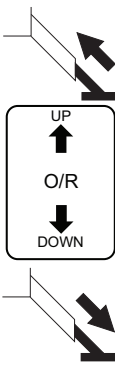

**CONTROLS BELOW ROTATION FUNCTIONS**

1.	Selector		<p>Move handle up to activate "UNIT" system.</p> <p><b>!</b> The Selector will function as an emergency stop by taking oil flow away from the active control.</p> <p>Move handle down to operate outrigger system "O/R'S".</p>
2.	Outrigger Controls		<p>Move handle "UP" to raise outrigger.</p> <p>Move handle "DOWN" to lower outrigger.</p>
3.	Hydraulic Tools (Optional)		<p>Return handle to center position to turn off.</p> <p><b>NOTE: Turn tool "OFF" before operating other functions.</b></p> <p>Move handle to energize tool quick couplers in direction required. "ON" direction energizes male coupler.</p>
4.	Engine Stop/Start (Optional)		<p>Push and hold to start engine. Release when engine starts.</p> <p>Push and release to stop engine.</p> <p><b>!</b> Can also be used to stop the Aerial Device in an emergency.</p>
5.	<p>Two-Speed Throttle (Optional)</p> <p>*Auxiliary Let Down Power (Optional)</p>		<p>With engine running, the throttle is activated.</p> <p>Push and release to increase engine RPM.</p> <p>Push and release to return to engine idle.</p> <p>With engine "OFF", the auxiliary let down power is activated.</p> <p>Push and hold to turn on auxiliary let down power.</p> <p>Release to shut off auxiliary let down power.</p> <p><b>NOTE: *Can be included with two-speed throttle circuit. When vehicle engine is disabled, the auxiliary let down power can be activated by the two-speed throttle switch.</b></p> <p><b>NOTE: *Do not operate longer than 30 seconds. Continuous operation will drain battery and/or overheat pump motor.</b></p>

## OPERATOR CONTROLS AND DESCRIPTIONS

Aerial Device functions may be controlled from either the upper controls at the platform or the lower controls station. The platform controls are used, in normal operation, by the operator to control the Aerial Device. The lower controls are used for inspection, maintenance, and in emergency situations. The top control shut-off at the lower controls determines which control station is operable. Only one is operable at any time.

The upper controls may be a single stick control and/or individual levers. The single stick control has one lever that controls all boom functions. The single stick has an enable lever that must be squeezed to allow operation of the boom functions. Center the single stick in the neutral position before depressing the enable lever. Always return the single stick to the centered or neutral position before releasing the enable lever. If the enable lever is depressed while the single stick is not in neutral the function will begin moving suddenly. If the enable lever is released before the single stick is returned to neutral the movement will be unpredictable. The individual levers control each movement separately. The enable lever and the tool control are either on or off. The actual controls on a machine will depend on the options it is equipped with.

Controls provide proportional metering of the function, meaning the distance the control lever is moved determines the speed. The farther the lever is moved from the neutral or center position, the faster the function will operate.

While learning to operate the Aerial Device, do not operate functions at full speed. First, operate each function separately. Then operate two or more functions together. Learn to move the platform in an arc to any desired position within reach of the platform. Operate the functions with smooth, gradual, starts and stops. Use full speed when in clear areas with no obstructions and slow speeds when approaching objects, the ground or truck. Smooth operation will get you to your work area quicker and more comfortably, with less wear and tear on the equipment. Anticipate the time it takes to stop, and begin slowing down beforehand, to stop without overshooting.

The single stick control and the individual levers use fiber optic enable switches. The switches are fiber optic devices that use a light switch at the platform to operate the function at the turntable below the insulated section of the booms. The light sources use battery power. The batteries are located in the control area enclosed in a plastic box. Each function uses two AA size lithium batteries. Change the batteries every 6 months to ensure operation. If the function fails to operate, replace the batteries before referring to the maintenance manual.

Single stick controls are high resistance controls and require periodic test and inspection. The high resistance controls are not rated and are not part of the insulating system that enables the aerial device to have an insulating rating.



**The high resistance single stick control does not provide protection in the event of electrical contact and is not a substitute for maintaining minimum approach distance, cover up, rubber gloves, and other personal protective equipment.**



	<p style="text-align: center;"><b>! DANGER</b></p> <p style="text-align: center;"><b>ELECTROCUTION HAZARD</b></p> <p><b>CONTROLS ARE NOT INSULATED OR ISOLATED</b></p> <p>All metal at boom tip is electrically connected. Operator contact with ANY, live or grounded, line or object while operator touches CONTROLS or BOOM TIP COMPONENTS and boom tip contacts any other line or object can result in</p> <p style="text-align: center;"><b>DEATH OR SERIOUS INJURY</b></p> <p>Comply with OSHA, ANSI, &amp; NESC requirements</p> <ul style="list-style-type: none"> <li>• Maintain proper CLEARANCE to all lines and objects</li> <li>• Wear Personal Protective Equipment: Fall protection; Eye protection; Insulating: gloves, sleeves, and hard hat; &amp; Special clothing</li> <li>• Cover all lines with insulated line hose or insulating blankets</li> <li>• DO NOT Depend on machine covers for insulation Plastic or fiberglass covers offer limited electrical insulation. Covers are NOT tested, certified, or maintained as insulating.</li> </ul> <p style="text-align: right;">463602A</p>
---	--

	<p style="color: red;"><b>Only the platform operator controls the Aerial Device during normal operation. Never operate the Aerial Device from the ground control with someone in the platform, except in an emergency situation.</b></p>
---	--

**LIFT LOCK HANDLES**

If a control lever at the upper controls operates a boom function, other than in the single stick, the control will have a lift lock handle.

A spring-loaded lever on each boom function lever locks the levers in a neutral position and prevents accidental actuation. A control lever placard indicates the direction to move the control lever to activate a specific boom movement. To activate a boom movement the handle must be pulled "up" and held, so the control lever can operate the desired boom function. When the handle is released the spring pulls the handle "down" to a neutral position and locks the control lever in that position.

**UPPER CONTROLS  
SINGLE STICK**

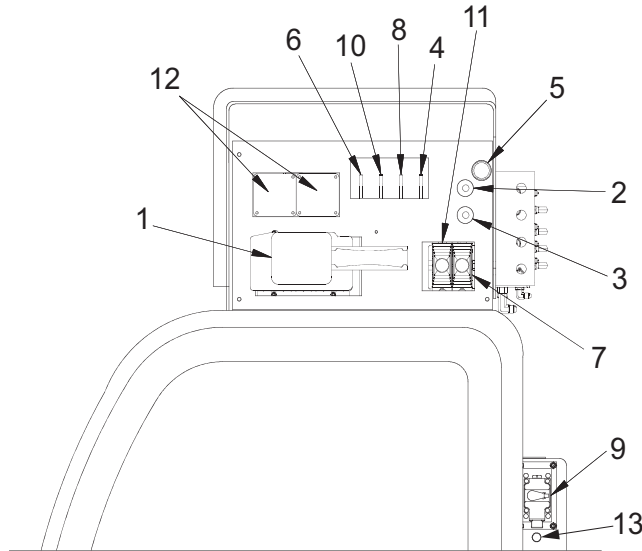

ITEM	CONTROL	DESCRIPTION
1.	Single Stick	Controls upper boom, lower boom, rotation, and upper boom extension.
2.	Engine Stop/Start (Optional)	Allows the operator to stop and start the engine from the platform.
3.	Two-Speed Throttle	Two-speed throttle provides two engine speeds, low and high, with engine running. Low speed is engine idle.
	Auxiliary Let Down Power (Optional)	Auxiliary let down power provides hydraulic power to lower and stow the Aerial Device in the event of a prime power source failure.
4.	Hydraulic Tools (Optional)	Directs the oil to flow to the tool when connected to the quick couplers. (Closed Center tools only)
5.	Stop	Diverts the oil to the tank to stop all operation of platform controls.
6.	Jib Articulation (Optional)	Allows the jib to be positioned at different angles.
7.	Winch (Optional)	Used for operating the winch during material handling operations.
8.	Platform Rotation (Optional)	Allows the platform to rotate toward the end of the boom tip.
9.	Platform Leveling	Allows the platform to be hydraulically tilted to level the platform. Utilized for emergency removal and platform clean out.
10.	Jib Extension (Optional)	Allows the jib to be hydraulically extended.
11.	Lower Boom Extend	Controls the Lower Boom extension.
12.	Fiber Optic Battery Box	Each box contains 4 AA size batteries which supply the electrical current to create the signal for the Fiber Optic Switch.
13.	Level Battery Low Charge Indicator	Illuminates if the leveling system battery is low. (Units equipped with generator)



**The decals are an integral part of this vehicle. If the decals are illegible, they must be replaced.**



**Always operate controls slowly and deliberately for smooth movements. Rough handling is never excusable and may cause damage to the Aerial Device and endanger the operator.**



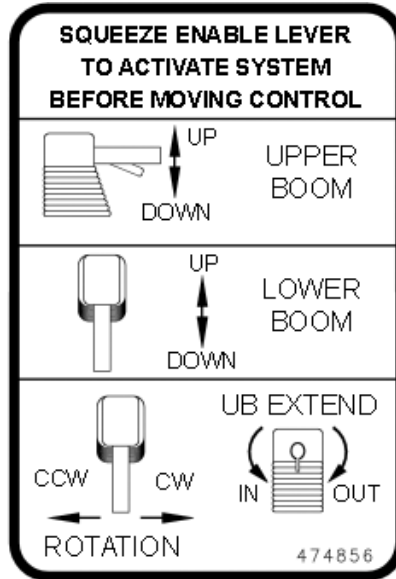

### SINGLE STICK FUNCTIONS

The control location shown is generic. The actual location will vary depending on purchasers requirements and options. Some of the following control functions may not be included in the controls for this Aerial Device. Refer to the control decals on unit for proper operation.



SINGLE STICK CONTROL LABEL





- 

**Be sure the control handle is in the centered neutral position before depressing enabling lever. Return the control handle to centered neutral position before releasing the enabling lever. Failure to observe these rules will cause sudden and unexpected movement of the platform. Serious injury or death could result when working in confined spaces or near electrical power lines.**
- 

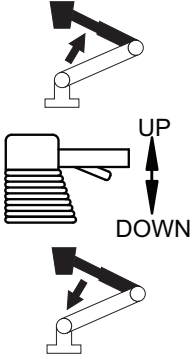
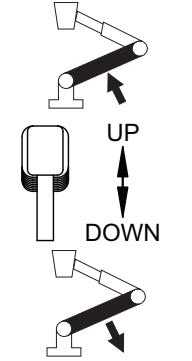
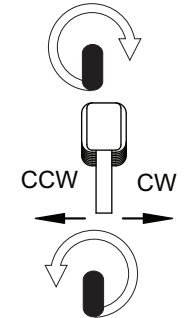
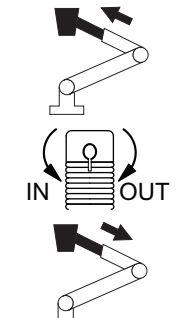
**The Aerial Device upper control station has metallic parts, which are necessary to provide the structural support for the various components. These metallic parts are interconnected. The main shaft that supports the platform and controls must also support other load carrying options that can be added to the boom tip.**

**The fiberglass upper and lower boom, in a well maintained condition, provides electrical insulation between the boom tip and the truck as a potential to ground. This fiberglass will not protect the operator in the platform if any portion of the boom tip, including options, is brought into contact with an energized or non-energized conductor and the operator is in contact with a different potential, such as, a grounded non-energized conductor. This type of contact can energize or ground the controls because as stated before, all components of the boom tip are interconnected. The fiberglass will not provide protection for the operator in phase to phase contact or a phase to ground contact, nor will it protect the vehicle from becoming energized if the steel boom section below the lower boom insert, if so equipped, is brought into contact with an energized conductor.**

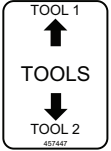
1.	Upper Boom		<p>Squeeze the enable lever and lift lever "UP" to unfold upper boom.</p> <p>Squeeze the enable lever and push lever "DOWN" to fold upper boom.</p>
	Lower Boom		<p>Squeeze the enable lever and push lever forward to unfold lower boom "UP".</p> <p>Squeeze enable lever and pull lever back to fold lower boom "DOWN".</p>
	Boom Rotation		<p>Squeeze the enable lever and rotate lever right to rotate booms clockwise "CW".</p> <p>Squeeze the enable lever and rotate lever left to rotate booms counterclockwise "CCW".</p>
	Upper Boom Extend		<p>Squeeze the enable lever and twist the lever clockwise to extend "OUT" the upper boom.</p> <p>Squeeze the enable lever and twist the lever counter clockwise to retract "IN" the upper boom.</p>

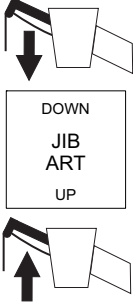
2.	Engine Stop/Start (Optional)		<p>Push and hold to start engine. Release when engine starts. Push and release to stop engine.</p> <p><b>⚠ Can also be used to stop the Aerial Device in an emergency.</b></p>
3.	<p>Two-Speed Throttle</p> <p>*Auxiliary Let Down Power (Optional)</p>	 	<p>With engine running, the throttle is activated. Push and release to increase engine RPM. Push and release to return to engine idle.</p> <p>With engine "OFF", the auxiliary let down power is activated. Push and hold to turn on auxiliary let down power. Release to shut off auxiliary let down power.</p> <p><b>NOTE: *Can be included with two-speed throttle circuit. When vehicle engine is disabled, the auxiliary let down power can be activated by the two-speed throttle switch.</b></p> <p><b>NOTE: *Do not operate longer than 30 seconds. Continuous operation will drain battery and/or overheat pump motor.</b></p>
4.	Hydraulic Tools (Optional)		<p>Push to select tool circuit number 1.</p> <p>Turn tool "OFF" before operating other functions.</p> <p>Pull to select tool circuit number 2, if equipped.</p>
5.	Stop		<p>Push to stop all operations at the platform controls. This diverts all oil to the tank.</p> <p>Pull to resume operation.</p>
6.	Jib Articulation (Optional)		<p>Push to lower jib boom "DOWN".</p> <p>Pull to raise jib boom "UP".</p>

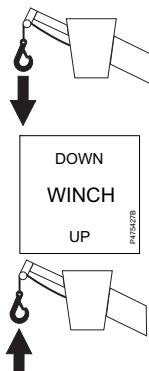
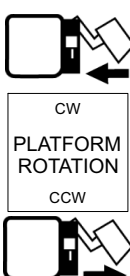
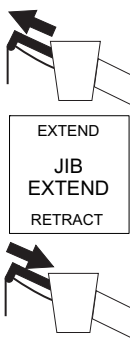
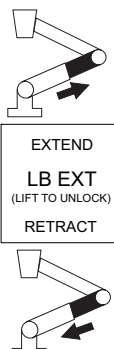

7.	Winch (Optional)	 <div style="border: 1px solid black; padding: 5px; text-align: center; width: fit-content; margin: 10px auto;">             DOWN WINCH UP <small>#174278</small> </div>	<p>Push to lower load "DOWN" or pay-out winch line.</p> <p>Pull to raise load or wind winch line "UP".</p>
8.	Platform Rotation (Optional)	 <div style="border: 1px solid black; padding: 5px; text-align: center; width: fit-content; margin: 10px auto;">             CW PLATFORM ROTATION CCW <small>#174278</small> </div>	<p>Raise lever by pulling upward to unlock. Push to rotate clockwise "CW" to end position.</p> <p>Raise lever by pulling upward to unlock. Pull to rotate counterclockwise "CCW" to stowed position.</p>
9.	Platform Level	<div style="border: 1px solid black; padding: 5px; text-align: center; width: fit-content; margin: 10px auto;">             PLATFORM LEVEL TILT ← → LEVEL USE ONLY IF PLATFORM DOES NOT LEVEL <small>#174278</small> </div>	<p>Squeeze single stick enable lever and move lever side to side.</p> <p>Push to right to rotate platform in level direction. Push to left to rotate platform in dump direction.</p>
10.	Jib Extend (Optional)	 <div style="border: 1px solid black; padding: 5px; text-align: center; width: fit-content; margin: 10px auto;">             EXTEND JIB EXTEND RETRACT <small>#174278</small> </div>	<p>Push to extend jib boom "OUT".</p> <p><b>⚠ Always have one pin installed to prevent jib movement.</b></p> <p>Pull to retract jib boom "IN".</p>
11.	Lower Boom Extend	 <div style="border: 1px solid black; padding: 5px; text-align: center; width: fit-content; margin: 10px auto;">             EXTEND LB EXT (LIFT TO UNLOCK) RETRACT <small>#174278</small> </div>	<p>Lift &amp; Push lever forward to "EXTEND" out lower boom.</p> <p>Lift &amp; Pull lever back to "RETRACT" in lower boom.</p>

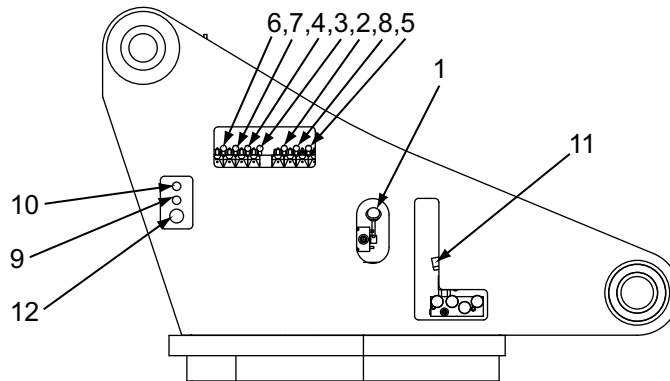
**LOWER CONTROLS**



ITEM	CONTROL	DESCRIPTION
1.	Top Control and Option Shut-Off 	Controls oil flow to the option valve and hydraulic tool at the platform. In the "OFF" position no oil is available at the platform valve. Must be in the "ON" position to operate the jib, winch, platform rotate and hydraulic tools at the platform location.
2.	Lower Boom	Controls lower boom articulation, upper maintains same angle to truck.
3.	Boom Rotation	Controls rotation of booms.
4.	Upper Boom	Controls articulation of upper boom.
5.	Platform Level	Allows the platform to be hydraulically tilted to level the platform. Utilized for emergency removal and platform clean out.
6.	Winch	Used for operating the winch during material handling operations.
7.	Lower Boom Extend	Used to extend the lower boom.
8.	Upper Boom Extend	Used to extend the upper boom.
9.	Engine Stop/Start (Optional)	Controls stop and start of the engine from the pedestal.
10.	Two-Speed Throttle (Optional)	Two-speed throttle provides two engine speeds, low and high, with engine running. Low speed is engine idle.
11.	Manual Let Down Power	Used to manually use boom functions in the event of a prime power source failure.
12.	Enable	Press and hold to operate lower controls.

**NOTE: Lower boom, upper boom, and rotation sequence may vary. Refer to decal on Aerial Device.**

-  **The decals are an integral part of this vehicle. If the decals are illegible, they must be replaced.**
-  **Always operate controls slowly and deliberately for smooth movements. Rough handling is never excusable and may cause damage to the Aerial Device and endanger the operator.**
-  **Use the Top Control and Option Shut Off to override upper boom controls with the lower controls if needed. It will stop all oil flow to the boom tip.**

### TOP CONTROL AND OPTION SHUT OFF

The Top Control and Option Shut Off is used to stop operation of the upper controls. It will stop all oil flow to the boom tip in case of an oil leak. It is also used to override the upper controls in case of an emergency. The upper controls are not operable when the Top Control and Option Shut Off is in the "OFF" position. The lower controls will operate with the shut off in either the "OFF" or "ON" position. Operate only one lower control at a time when overriding the upper control.

If the operator is unable to operate the Aerial Device, determine if any damage has occurred to make the Aerial Device inoperable. If the situation allows safe operation from the lower controls, override the upper controls and carefully lower the platform to the ground. If the Aerial Device will not operate due to the damage incurred, consider one of the other auxiliary operating procedures presented in the section to solve the problem.



**Use the Top Control and Option Shut Off to override the upper controls. The "off" position stops oil flow to the upper controls and options at the boom tip.**

### LOWER CONTROL FUNCTIONS

The control location shown is generic. The actual location will vary depending on the purchaser requirements and options. Some of the following control functions may not be included in the controls for this Aerial Device. Refer to the control decals on unit for proper operation.

The control levers are self-centering, spring-loaded, and return to the neutral position when released.

The hydraulic platform tilt (optional) allows the platform to be tilted for cleaning out the platform and for personnel rescue. Lower controls must be selected for this option to be functional and must never be operated with personnel in the platform except in the case of an emergency.

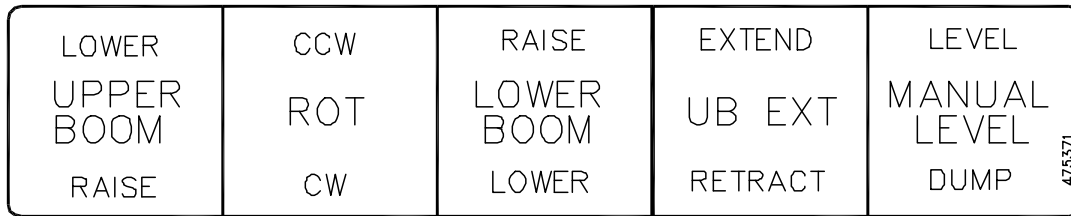
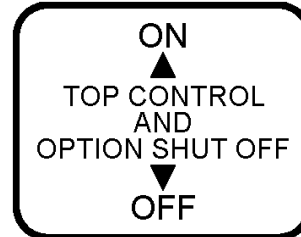
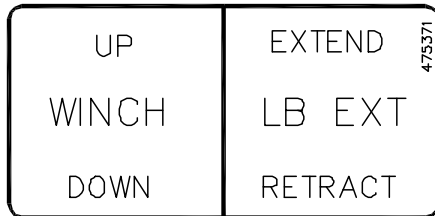







**Keep the truck bed area free of obstructions to avoid interference with the lower controls and personnel who may have to operate the lower controls in an emergency.**



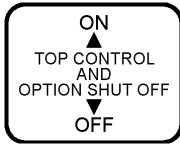

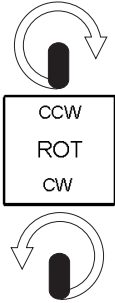

**Do not operate controls while standing on the ground or other structure with booms elevated from stored position. Operating the machine while standing on the ground or other structure could result in electrocution.**

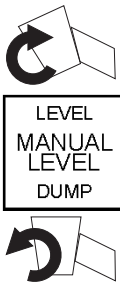
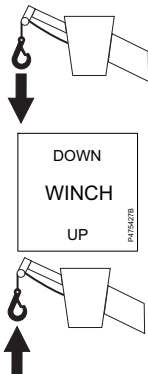

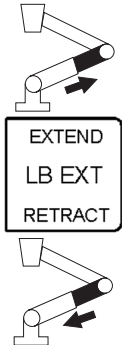
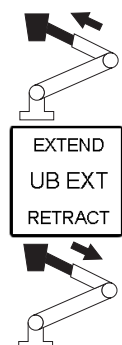
1.	Top Control Shut-Off		<p>Pull up to turn "ON". Push down to turn "OFF".</p> <p>Must be in the "ON" position to operate the jib, winch, platform rotate and hydraulic tools at the platform location.</p>
2.	Lower Boom		<p>Push lever forward to "RAISE" lower boom up.</p> <p>Pull lever back to "LOWER" lower boom down.</p>
3.	Boom Rotation		<p>Push lever forward to rotate booms to the right or counterclockwise "CCW".</p> <p>Pull lever back to rotate booms to the left or clockwise "CW".</p>

4.	Upper Boom		<p>Push lever forward to "LOWER" lower boom down.</p> <p>Pull lever back to "RAISE" lower boom up.</p>
	Upper Boom (TM125 only)		<p>Pull lever back to "RAISE" lower boom up.</p> <p>Push lever forward to "LOWER" lower boom down.</p>
5.	Platform Level		<p>Push lever to "LEVEL" platform.</p> <p>Pull lever to "DUMP" platform.</p> <p><b>⚠ Do not operate with personnel in the platform.</b></p>
6.	Winch (Optional)		<p>Push to lower load "DOWN" or pay-out winch line.</p> <p>Pull to raise load or wind winch line "UP".</p>

7.	Lower Boom Extend		<p>Push lever forward to “EXTEND” out lower boom.</p> <p>Pull lever back to “RETRACT” in lower boom.</p>
8.	Upper Boom Extend		<p>Push lever forward to “EXTEND” out upper boom.</p> <p>Pull lever back to “RETRACT” in upper boom.</p>
9.	Engine Stop/Start (Optional)		<p>Push and hold to start engine. Release when engine starts. Push and release to stop engine.</p> <p> <b>Can also be used to stop the Aerial Device in an emergency.</b></p>
10.	Two-Speed Throttle (Optional)		<p>With engine running, the throttle is activated. Push and release to increase engine RPM. Push and release to return to engine idle.</p>
11.	Manual Let Down		<p>The Manual Let Down system works by gravity only. It can not raise a boom or level. See “MANUAL LET DOWN SYSTEM” in Operator’s Manual for operating instructions.</p>

## ACCESSORIES

The Accessory controls and the enable on the single stick are fiber optic devices that use a light switch at the platform to operate the function. The light source uses battery power. The batteries are located in the control area enclosed in a plastic box. Each function uses two AA size lithium batteries. If the function fails to operate replace the batteries before referring to the maintenance manual and performing other service work.

## ENGINE STOP/START CONTROL (OPTIONAL)

The engine stop/start system allows the truck engine to be stopped and restarted from remote locations. Controls may be located in the cab, at the outrigger control location, at the pedestal or lower controls, or in the platform.

Before attempting to start the engine, make sure the transmission is in neutral, the parking brake applied, and the wheels are chocked.

To start the engine make sure the vehicle key is in the run position and the master switch in the cab is "ON". Push the control labeled "ENGINE" and hold until the engine starts, then release.

The engine will crank as long as the switch is held in the "START" mode. If it fails to start, release and let the starter cool down. The control toggles between start and stop mode, so it is necessary to push and release, then push again to crank the engine if the engine fails to start.

To stop the engine push the switch and then release. Refer to Emergency Operation for further information on the use of this control in an emergency.

## TWO-SPEED THROTTLE CONTROL (OPTIONAL)

The two-speed throttle control allows the engine speed to be increased to a high idle position or reduced to the normal idle speed from remote locations. This gives the operator a choice of an efficient, economical engine idle speed with slower boom movement or a faster engine speed with faster boom movements when required. Controls may be located at the outrigger control location, at the pedestal or lower controls, or in the platform. The control will alternate the engine speed between the high and standard idle speeds.

- To increase engine speed, push the switch or air plunger and release.
- To decrease engine speed to an idle, push the switch or air plunger and release.

**NOTE: The two-speed throttle is not required when the Aerial Device is ordered if the Aerial Device is equipped with a "demand throttle" which increases engine speed automatically when a control is activated.**

## AUXILIARY LET DOWN POWER CONTROL (OPTIONAL)

If the power source for the Aerial Device fails, the auxiliary let down power control activates power to stow the Aerial Device if the vehicle electrical system and the hydraulic system is operable. The auxiliary let down power control is combined with the two-speed throttle control. If the engine is not running, the auxiliary let down power is turned on and off by pressing and holding or releasing the two-speed throttle push button. If Aerial Device is not equipped with the two-speed throttle, the control only operates the auxiliary let down power.

**NOTE: The auxiliary let down power system should not be operated longer than 30 seconds continuously. Continuous use will drain the battery and damage (overheat) the auxiliary pump motor.**



## MANUAL LET DOWN SYSTEM

Assess the boom position and identify any obstructions. Remember when using the manual letdown, the lowering of the upper boom, lower boom, and the lower boom extension are all done by gravity. None of the interlock systems will operate. The platform will not level as the booms are lowered. Plan the movements required to get the platform to the ground before using the manual letdown system.

The unit can be rotated using a hex fitting on top of the rotation motor.

The manual letdown will not extend or retract the upper boom or the Jacks.



**Operate only one function at a time. Selecting more than one function can cause unexpected movement causing failure to place the platform at the desired location on the ground or prevent the platform from reaching the ground.**

Once the manual letdown system has been activated, all four of the letdown controls must be returned to neutral to stop the motion of the boom.



**The platform will not level when using the manual letdown.**

### MANUAL LET DOWN

The manual let down system works by gravity only. It can not raise a boom or level. Plan the movements required to get the platform to the ground. The let down system lowers only the Lower Boom, Upper Boom, Lower boom extension and will release the Rotation Brake to allow manual rotation.

**OPERATION INSTRUCTIONS:**

Only operate one function at a time.

1. Select the boom function desired for the sequence planned. Pull and twist the knob to lock in "OUT" position.
2. Use pump handle stored on control cover to pump up pressure, (about 2 strokes).
- Ⓐ Engage push button on valve, until the function begins to move or you can rotate the gearbox hex shaft.
3. Slowly meter with lower control lever in "down" direction to increase speed.
4. To stop movement of function move selector to "IN" position.
5. Repeat for the next function in planned sequence.
6. To rotate, turn knob "CW" and pump up (about 2 strokes) to release brake, then manually rotate with 7/8" wrench on rotation motor shaft.

Return all selectors to "IN" or "CCW" position for normal operation. After using the manual let down function cycle boom through full range of motion from the lower controls before operation from the platform.

Note: Platform leveling will not function when using manual let down.  
Boom movement will not stop until selector is in "IN" or "CCW" position.

480723



When the manual letdown is used, none of the safety limit systems are operational. Unless the unit needs to be rotated to clear obstacles.

If the platform or the boom is near any obstacles and needs to be rotated away before lowering the unit, rotate it by turning the far right knob to 3 o'clock.



The safety limit systems are not operational when using the manual letdown.

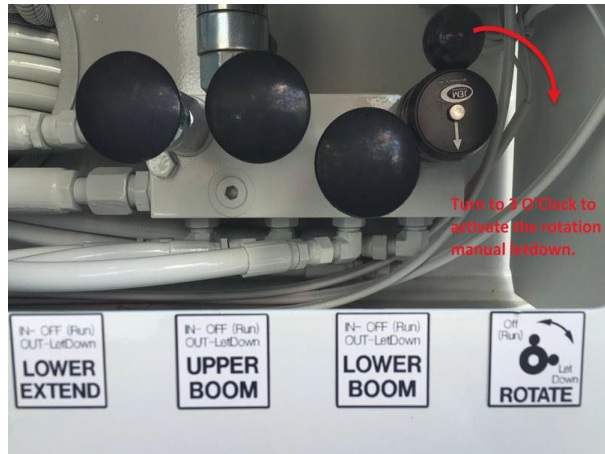

**OPERATION INSTRUCTIONS:**

1. Use the jack handle, pump up the handle until it gets hard, (you may need to keep pumping the jack intermittently to keep brake released).
2. Push the counterbalance override on the brake valve and use the 7/8" wrench to rotate the unit.



## TM SERIES

When the manual override button is released, rotation will be stopped. Turning the knob back to its original position will also stop rotation.

If the brake valve does not have the manual override button, a lot of force is needed to rotate. You can turn the counterbalance valves in clockwise to decrease the pressure and allow manual rotation.



**The counterbalance valves must be reset before the unit is returned to service.**

### Lower boom extension letdown:

1. Pull the first knob on the left side and then turn to lock it in the “in” position.
2. Pump the handle until the boom starts to come down.
3. Make sure that lower boom extension retract fully, before lowering the lower boom.



4. The lower boom extension will retract quicker by moving the handle of the lower boom extension valve, allowing oil to go back to tank faster.



5. Pull the manual letdown knob to stop the boom and turn back to the normal position. This will close the pilot valve stopping the movement.
6. Depending on the positions of upper and lower booms, it will determine which boom must be lowered next. Remember that the booms come down with GRAVITY only and none of the limit systems will work.

This includes the over-center limit system. Do not allow the platform to go past the vertical center of rotation at any time.

 **The safety limit systems are not operational when using the manual letdown.**

 **Do not allow the platform to go past the vertical center of rotation at any time.**

**Upper boom letdown:**

1. Pull the second knob from the left and lock it in the “out” position.
2. When movement stops push it back in and pump the jack up again.
3. Next pull the third knob from the left (lower boom) until movement stops.
4. Repeat the functions as necessary between upper boom and lower boom.

 **The safety limit systems are not operational when using the manual letdown.**

 **Do not allow the platform to go past the vertical center of rotation at any time.**

 **The platform will not level when using the manual letdown.**

 **Only manually operate one function at a time.**

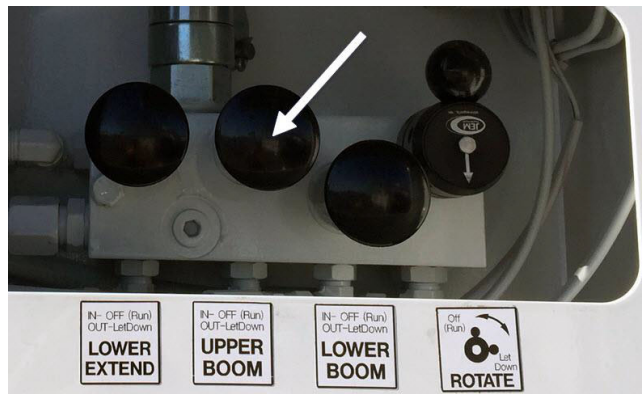

If the position of the upper and lower booms allows the lower boom to be lowered, first lower the lower boom. Make sure that the platform does not go past center of rotation. Then lower the upper boom. It may be necessary to keep pumping the manual letdown jack to maintain pressure to the pilot valves.





 **The lower boom extension must be fully retracted before lowering the lower boom.**

Lowering both booms individually back and forth will help prevent the platform from completely dumping upside down. If the upper boom is lowered first, the platform could be completely upside down depending on the angle of the boom starting position.

 **The safety limit systems are not operational when using the manual letdown.**

 **Do not allow the platform to go past the vertical center of rotation at any time.**

 **The platform will not level when using the manual letdown.**

 **Only manually operate one function at a time.**

**NOTE: Remember to return all the letdown valves back to the “in position” for Lower, Upper Boom and Lower boom Extension. Turn the Rotation back to 12 o’clock for normal operation.**

Before returning the unit to service and allowing anyone to operate the platform, purge the air that entered in the cylinders during manually lowering operation.

 **Any air that has entered the hydraulic system must be purged before the unit is placed back into service or anyone is allowed to operate the unit from the platform.**

To remove the air, retract the upper boom, lower boom and lower boom extension cylinders before extending the cylinders through their full range of motion.

Cycle the lower boom lift not more than 45 degrees 3 times with the upper boom opened far enough to clear the body. Then cycle the lower boom fully.

With lower boom raised, extend the upper boom up and down then extend the lower boom cylinder out fully before retracting. Run the cylinder through the full range of movement twice.

The lower boom will not extend until it is above the minimum angle for the lower boom limit system:

- For TM125 models the lower boom needs to be above 70 degrees.
- For TM105, TM100, and TM85 models the lower boom needs to be above 55 degrees.

 **When operating Manual Let Down system the operator must ensure booms stay in allowable operating range to prevent tip over or structure failure. No interlocks and limit system functions when using Manuals Let Down system. Retract lower boom before lowering lower boom.**

## HYDRAULIC TOOLS (OPTIONAL)

Hydraulic tool circuits are used to attach hydraulic powered hand tools to the hydraulic system of the Aerial Device. Quick-disconnect couplings are used to attach hydraulic tools. There may be one or two sets of tool couplers. Only one set of tools can be used at a time.

The tool circuit is for closed center hydraulic tools only. Use of open center hydraulic tools will create a heat problem. Operate tools at low engine speed if equipped with two speed throttle.

## CONNECTING TOOLS

- Clean off couplers before making connections.
- Ensure the tool is off, center position, then connect the tool's return hose to the return coupling and the pressure hose to the pressure coupling.
- To remove tools, turn tool off, center position, then disconnect the pressure coupler first then the return coupler.
- Place dust covers on couplers to keep clean when not in use.



**Only use hoses marked “non-conductive” on tools. The use of tools with hoses that can conduct electricity may cause serious personal injury or death in the event that such hoses come near or in contact with energized power lines.**

## USE OF TOOLS

- When tools are not required store them in the truck storage compartments. This will prevent damage to the tool and eliminate the chance of the tool falling.
- Remove tools from the platform when storing Aerial Device for transport.
- Turn tool off when not using tool.
- Do not operate hydraulic hand tools continuously. Continuous operation will cause overheating of the Aerial Device's hydraulic system.
- Turn tool circuit off when moving boom or platform.
- Use only orange, non-conductive hoses, on hydraulic tools.
- Be aware of where the tool hoses are to prevent snagging or contact with objects.
- Do not contact any conductor, pole, guy wire, or any objects with tool hoses, tool couplers or tool fittings. Contact can damage tool circuit and cause a leak.



**Contact of tool hose, quick coupler, or hose fittings against conductors can cause an arc that will burn through hose or fitting and result in a fire.**



**Hydraulic oil is flammable.**

## PLATFORM TILT



**Do not allow anyone to operate the platform tilt device while occupants are in the platform. Serious personal injury or death could result from platform upsetting.**

The platform leveling system permits the platform to be tilted to clean out water and debris. It also allows the platform to be tilted for personnel rescue. The control is located at the upper controls and lower controls.

The platform can be tilted with the lower boom raised fully and the upper boom folded to get close to the ground (operate from lower controls only).

When using the tilt function do not get in the platform. Operate from the upper controls only while standing on the ground alongside the platform or from the lower controls.

Tilting Operation:

1. Rotate the platform to the end mount position.
2. Use the lower controls to position lower boom up and upper boom so platform is near the ground.
3. Check for obstructions or people before moving the platform.
4. Move the leveling control to dump the platform while standing alongside the platform.
5. Return the platform to level position before moving the booms.

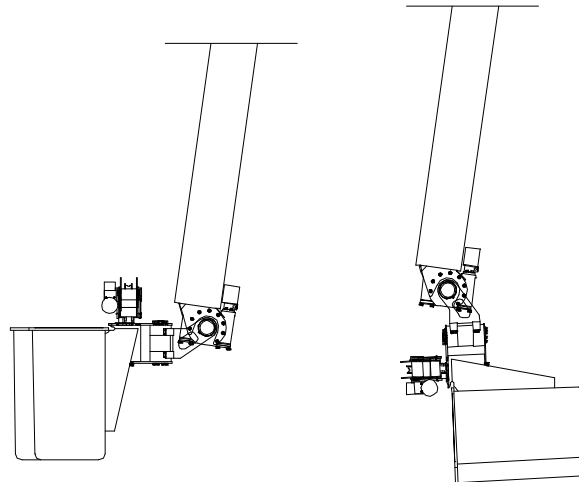

**NOTE: Return the platform to level before moving the booms.**

To operate from the upper controls or override leveling squeeze enable lever and move lever side to side to activate (DO NOT lift control lever).



**Slide lever side to side only, attempting to lift lever will damage valve and cause malfunction.**

## PLATFORM LEVELING (WITHOUT GENERATOR)

The platform level control is an electro-hydraulic system controlled by a level sensor, control system and a hydraulic servo valve to keep the platform level. As the upper boom or lower boom articulate the level will turn on to allow operation and keep the platform level. The sensor and control system operate from a 12 volt battery located under the platform rotator. The system is equipped with a low battery alarm. If an alarm is heard during operation the battery must be exchanged with the battery located in the cab of the truck. One battery must always be charging in the cab of the truck. The battery should be changed once a month to keep the system operating most efficient.



If the platform is more than 15 degrees out of level the level control system will turn off and not level until it is manually leveled to less than 15 degrees from level position.

The hydraulic pressure for the level system comes from the lower control hydraulic system. If the "Top Control Shut-off" control is in the "OFF" position there is no oil flow to the level system. The platform will not level without hydraulic pressure. If the top control shut-off must be "OFF", then the lower level control may be used to level the platform as the booms are moved. Move the boom slightly, stop the boom movement and level the platform then move the boom again. Repeat as needed to get the platform to ground level. Repair the system as needed before operating from the platform.

To manually operate the platform level from the upper controls the single stick enable must be energized then the level control lever moved the appropriate direction.

## PLATFORM LEVELING (WITH GENERATOR)

The platform level control is an electro-hydraulic system controlled by a level sensor, control system and a hydraulic servo valve to keep the platform level. As the upper boom or lower boom articulate the level will turn on to allow operation and keep the platform level. The sensor and control system operate from a 12 volt battery located under the servo valve. The battery is maintained by a generator located under the platform rotator. If the battery is low on charge, an indicator light on the operators dash will turn on.

**NOTE: The light will only turn on when the single stick enable is depressed and a boom function is moved slightly.**

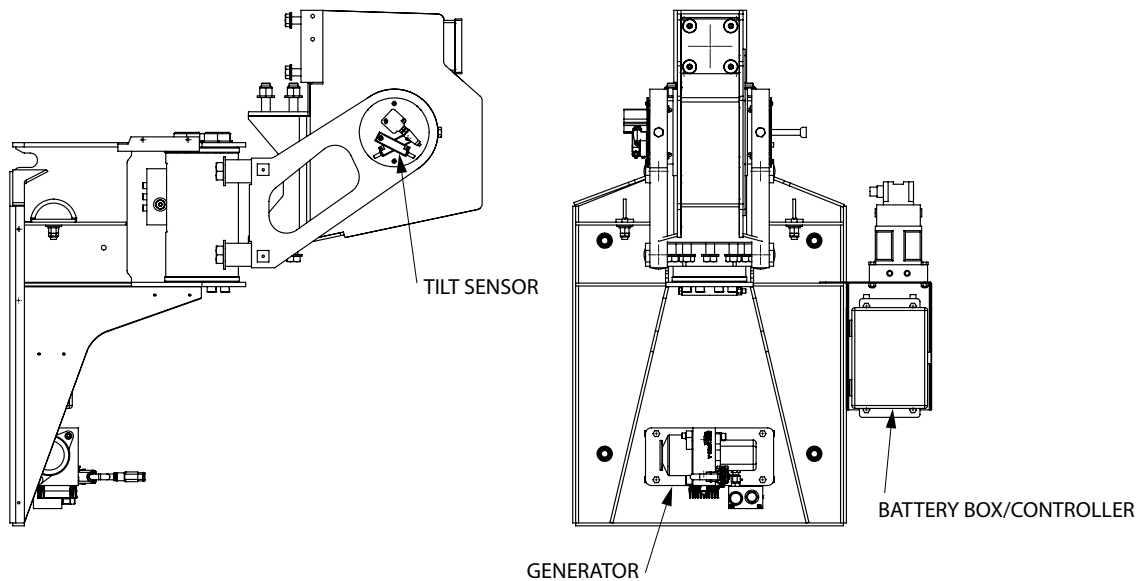

If the platform is more than 15 degrees out of level the level control system will turn off and not level until it is manually leveled to less than 15 degrees from level position.

The hydraulic pressure for the level system comes from the lower control hydraulic system. If the "Top Control Shut-off" control is in the "OFF" position there is no oil flow to the level system. The platform will not level without hydraulic pressure. If the top control shut-off must be "OFF", then the lower level control may be used to level the platform as the booms are moved. Move the boom slightly, stop the boom movement and level the platform then move the boom again. Repeat as needed to get the platform to ground level. Repair the system as needed before operating from the platform.

To manually operate the platform level from the upper controls the single stick enable must be energized then the level control lever moved the appropriate direction.

## PLATFORM ROTATOR (OPTIONAL)

The platform rotator allows operator to rotate the platform from the stowed position to the rotated position (end position). When not in use the platform must be placed in the stowed position.



**Prior to platform rotation, observe all obstructions and hazards near the platform's swing path to avoid collisions and contact with lines. Contact with obstruction or lines could cause serious personal injury or death.**

Move the rotator control handle or lever smoothly and gradually for slow platform rotation. Avoid sudden starts or stops when rotating the platform.

When moving the booms, position the platform in stowed position. Rotate platform into desired work position when in work area. Return to stowed position, after work is complete to travel back to ground.

Always store for travel in the stowed position.

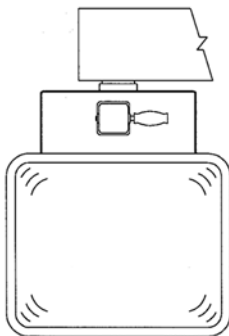

**STOWED POSITION**

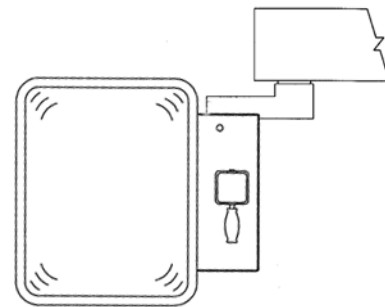

**ROTATED (END) POSITION**



**Keep hands away from all moving parts on the rotator assembly when operating or servicing.**

## JIB & WINCH OPERATION (OPTIONAL)

When operating the winch under load, always use a smooth movement for lowering or raising loads to avoid shock loads and sudden changes in truck balance. These dynamic shocks can have an effect on the structural members of the Aerial Device. Slow movement should be used on all heavy loads at low engine speed.

Position the Aerial Device so that the boom is properly placed to bring the material to be hoisted to the desired location. This includes adjusting the jib length and angle position.

The jib boom sheave head must not be turned horizontal in respect to the vertical lifting direction it is intended to be used in. Operating in this manner will cause a side load rather than the intended vertical load. The jib and sheave head should not be used in this way. The potential for overload is high, especially to the boom rotation system. The jib and load line should be used for vertical lifting only.

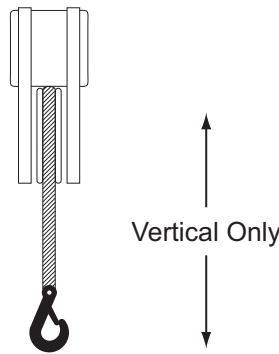

JIB POSITIONING

- |  |  |
|--|--|
|  | <b>Never allow personnel to be under loads being lifted.</b>   |
|  | <b>Increasing the horizontal distance from the vehicle to the load will affect the stability of the vehicle. Structural damage or instability can result in serious injury or death.</b>   |
|  | <b>Do not pull, drag, or jerk loads using the winch or rotation controls. This can overload and cause damage to rotation mechanism and other structural components, which can result in serious injury or death.</b>   |
|  | <b>When lifting loads, the boom will deflect a certain amount and when the load is relieved, the boom will return to the normal position. Always allow extra clearance above and below the boom from any obstacle when lifting a load to allow for this deflection. Serious injury or death can result from such deflections are not considered.</b> |
|  | <b>Never exceed the rated load capacity of the Aerial Device. Structural damage or instability can result causing death or serious injury.</b>   |
|  | <b>Do not pull poles or objects embedded in the ground. It is impossible to know the force applied. Aerial can fail from overload or eject occupants.</b>  |

## JIB ROTATION

Jib rotation is a manual operation with 5 locking positions. To rotate the jib, release the locking pin located at the rear of the jib. Manually rotate the jib to one of the 5 locking positions.

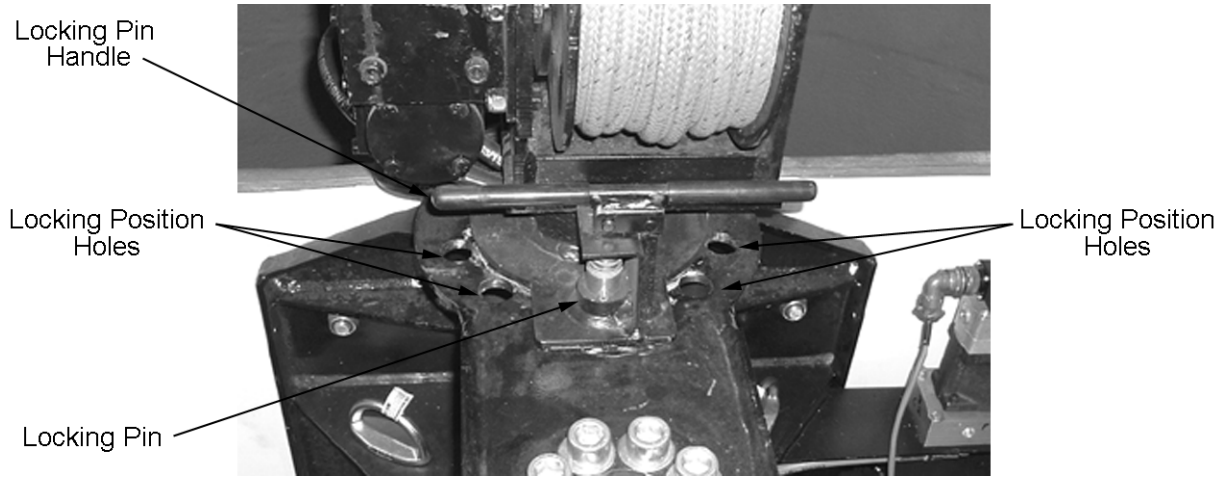

COVERS REMOVED FOR CLARITY



**Do not operate the jib without the locking pin securely locked into one of the designated locking positions.**

## MANUAL JIB EXTENSION

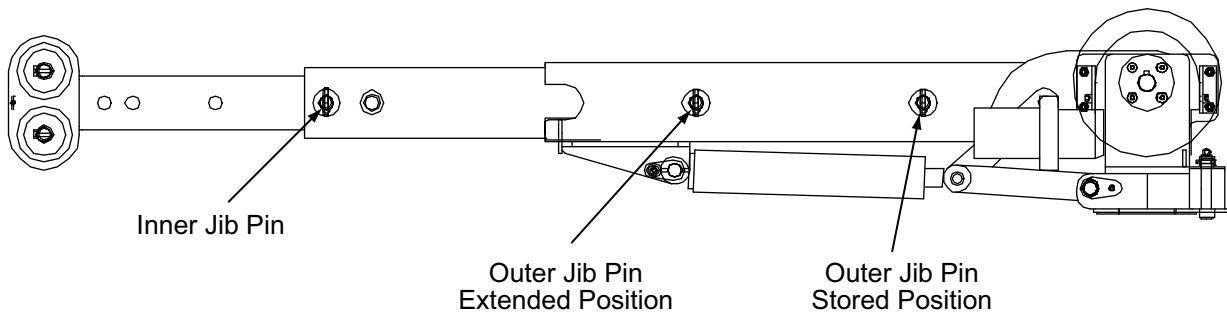

Both the 1st inner and 2nd outer jib extensions are manually operated. To extend the inner jib section:

1. Pull the inner jib pin and manually pull the inner jib to the desired extension. It will extend up to 17 inches.
2. Replace the inner jib pin.

To extend the 2nd extension:

1. Pull the outer jib pin and manually pull the outer jib to the desired extension.
2. Replace the outer jib pin in the extended position.

**NOTE: Do not extend or retract the jib with a load suspended, adjust prior to lifting the load.**



### HYDRAULIC JIB EXTENSION (OPTIONAL)

The jib extension can be adjusted hydraulically in the range of cylinder movement. If the jib must be extended or retracted more than cylinder stroke allows do the following:

Do not extend under load.

1. Install pin (2) and remove pin (1).
2. Extend or retract cylinder to next hole for desired direction and insert pin (1).
3. Remove pin (2).
4. Hydraulic extendable jib is now ready for use.
5. If a longer jib is required, repeat steps 1 and 2.

**NOTE: One pin, either (1) or (2), must always be installed to hold jib in position.**

**NOTE: Cannot extend under load except as a conductor lift when the jib is within 30 degrees of vertical.**

**NOTE: Do not extend or retract the jib with a load suspended, adjust prior to lifting the load.**

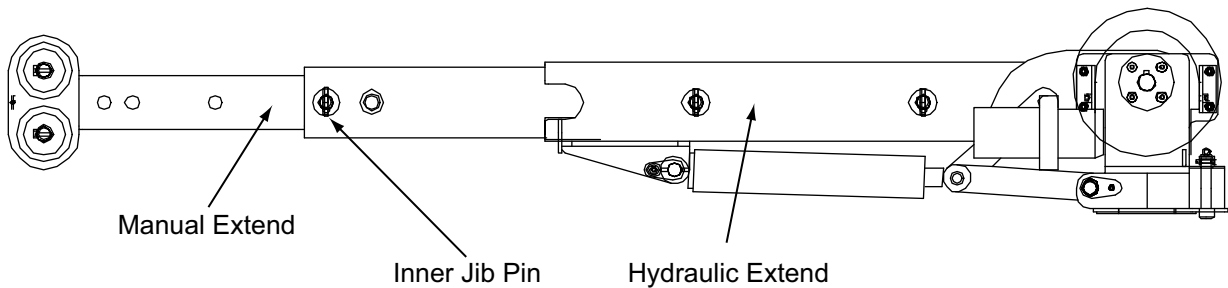

### DETERMINING LIFT CAPACITIES

The Aerial Device is equipped with a load chart located at the top controls inside the cover.

The load capacity must be assured for the entire range of the boom motion throughout a lift. Must insure capacity is not exceeded at any point during load movement.

After placing booms and jib in position for lifting the load. Refer to the load chart and find the number below the pointer in line with the load radius. The load radius is defined on the jib capacity chart. The capacity given here is the capacity of the machine for the unit's position. The capacity is the lower capacity if not fully retracted.

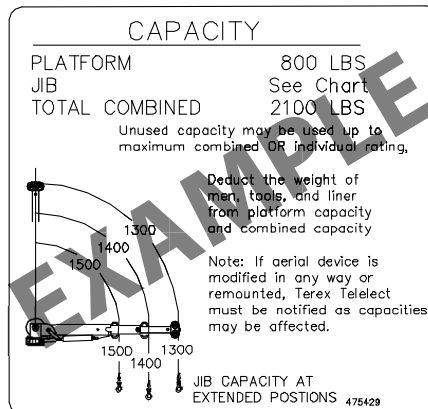



**NOTE: Load charts shown are for an example only. Each Aerial Device has its custom made load chart which may have different capacities than shown here.**

**NOTE: The capacities given on the unit load chart are based on unit setup with the turntable or truck bed being level.**





- 

**Use only synthetic rope for winch line. Do not use wire rope.**
- 

**Do not allow winch line to come in contact with guyline, pole, crossarm, ground, or any object that can create a path to ground or energize the winch line.**
- 

**Dirt, grease, other foreign matter, moisture and humidity will all contaminate the winch line - keep it clean.**
- 

**Death or serious injury will result if winch line becomes energized.**
- 

**Inspect rope daily before use.**
- 

**Use only hooks with a safety latch.**

**AVOID TRAPPED LOOPS**

When winding a line with no load back to the winch drum, lower the boom so that a crewman with gloves can make sure that it is wound level. Trapped loops will damage the winch line or cause a load to drop on the next winch pay out operation.

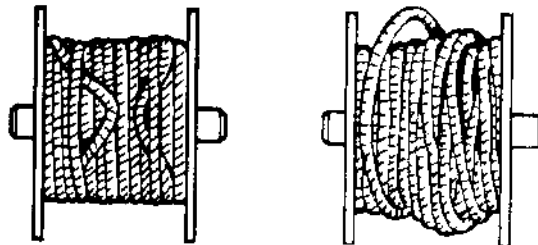

- 

**Always keep the winch line wound level and tight on the winch drum.**
- 

**Do not pull poles or pull any objects embedded in ground. Death or serious injury will result.**
- 

**Be sure load line is capable of lifting the load. Personal injury or death could result if load line breaks when lifting the load.**
- 

**Do not use winch line as a sling with the load line hooked back on itself - use a separate sling or rigger.**

## LOWER BOOM LIFTING EYE MATERIAL HANDLING (OPTIONAL)

A lifting eye may be provided to be used for limited material handling. For maximum lifting capacity, refer to the load chart installed on the Aerial Device.

- Always extend the outriggers.
- Boom movements should be smooth to avoid swinging the load.
- Operate only from the lower control station.
- Do not exceed the load limits stated on the decal beside the lifting eye.
- To prevent damage to the Aerial Device, avoid dragging the loads with the lifting eye. This would subject the Aerial Device to damaging side loads.
- When lifting loads, position the boom directly over the load before lifting.
- Be aware of platform location. Raise boom so platform clears the body and other objects.
- The platform shall not be used for material handling.

	<b>Never exceed the rated load capacity of the Aerial Device. Structural damage or instability can result causing death or serious injury.</b>
	<b>When the vehicle is not level, extreme caution must be used when rotating loads to the low side because the vehicle's stability will be affected.</b>
	<b>Increasing the horizontal distance from the vehicle to the load will affect the stability of the vehicle. Be careful when lifting and lowering a load with the boom.</b>
	<b>Any hooks used in conjunction with the lifting eye must be equipped with a safety latch.</b>
	<b>No personnel allowed inside the platform when using the lower boom lifting eye. Serious personal injury or death could result.</b>
	<b>Be sure load line is capable of lifting the load and inspect before use. Personal injury or death could result if load line breaks when lifting the load.</b>

## PERSONNEL AND TRAINING

All personnel assigned to an Aerial Device shall be given an opportunity to become familiar with the operation of the equipment before they operate it on a job. The operator and all other personnel should be familiar with the operating procedures. The operator and personnel shall perform training operations until they attain a safe degree of proficiency.

**NOTE: Refer to the load chart for rated capacities, boom angles and load radius.**

**NOTE: Do not exceed load chart capacities.**

DANGER

**FAILURE TO OBEY THE FOLLOWING  
WILL RESULT IN  
DEATH OR SERIOUS INJURY**

- For stationary operation, truck must be securely parked, driveline disengaged, and Aerial Device properly stabilized prior to operation.
- To avoid tip-over, outriggers (when so equipped) must be properly extended on a solid level surface.
- Operate all controls slowly for a smooth platform motion and make sure controls are returned to neutral after desired operation.
- Crew must use proper personal and other protective equipment.
- Never load beyond rated capacity.
- Never operate Aerial Device with personnel under boom or load.
- Never move the truck until the booms and outriggers are in a properly stowed position and secured.
- Refer to the operator's manual for complete instructions. If missing, replace manual.

419262

DANGER

**AN UNTRAINED OPERATOR  
SUBJECTS HIMSELF AND  
OTHERS TO  
DEATH OR SERIOUS INJURY  
YOU MUST NOT OPERATE  
THIS MACHINE UNLESS**

- You have been trained in the safe operation of this machine.
- You have read, understand and follow the safety and operating recommendations contained in the machine manufacture's manuals, safety signs attached to equipment, your employer's work rules and applicable government regulations.
- You are sure the machine is operating properly and has been inspected and maintained in accordance with manufacturer's manuals.
- You are sure that all safety signs, guards and other safety features are in place and in proper condition.

419267

Learn the operators inspection and field maintenance requirements. Many times simple maintenance procedures can prevent expensive breakdowns. A brief preliminary check of oil levels, operating conditions of the Aerial Device, and visual inspection of pins, fasteners, and the hydraulic system should be made daily before the unit is put into service.



**If service is indicated, do not delay. Malfunction of one component can cause serious injury to the operator or to others if not corrected immediately.**

The operator should also know the brand and grade of oil used in the hydraulic system and where more can be obtained if additional oil is needed.

It takes a desire to learn and a pride of accomplishment on the part of the operator to achieve the proficiency and technique of operation necessary to get the most out of this equipment. The equipment will make the job easier and more enjoyable if a high degree of proficiency is attained.



**The ground crew must be trained to operate the Aerial Device in case of emergency.**

**A WELL TRAINED CREW IS A PRODUCTIVE CREW!**



## PRE-OPERATION

### DAILY PRE-OPERATION CHECKS

Perform all daily inspections as shown in Frequent and Periodic Inspection immediately prior to first use at the beginning of each shift.

### JOB SITE SURVEY

Before locating the vehicle in position to work, make a complete survey of the job site. During the survey, some of the items to look for include the following:

- Ambient conditions including temperature.
- Consider the slope of the ground. Unit is tested on maximum 5 degree ground slope.
- Determine if the ground is firm enough to support the Aerial Device. If the vehicle must be parked on a slope, always keep the boom on the uphill side, chock the wheels, and work off the rear of the vehicle. If the ground is not firm enough, use pads under the outriggers and crib as needed to distribute the load.
- If unit is not equipped with outriggers, or only has one set of outriggers, evaluate the tire contact area. All tires and axle suspension springs must be equally loaded prior to setting outriggers.
- Look for ditches, drop-offs, holes, debris, and overhead utility and power lines.
- If grass or shrubs will be underneath when the vehicle is setup, cover grass or shrubs with dirt to prevent a fire.
- Determine the vehicle position needed to accomplish the work safely. If it is not safe to proceed use another method or setup.

## OPERATING TEMPERATURE RANGE

The ambient operating temperature range of the unit is given on the ID plate. Operation at the extremes of the temperature range requires extra precautions.

Cold weather operation below 10 degrees F (-12 degrees C) requires:

- The hydraulic system must be filled with hydraulic fluid having a pour point suitable for the temperature.
- The hydraulic system must be properly warmed up:
  - Operate the pump at idling speed to allow the oil to warm up gradually. Cold, thick, sluggish oil may not move fast enough and will starve the pump, thus causing severe damage.
  - Circulate the oil through the outrigger system by cycling each outrigger several times before setting up for boom operation.
  - Circulate the oil through the system by cycling each function from the lower controls before operation from the platform.
  - The addition of oil heaters may be required.
- Operate the boom and functions slowly to prevent jerking and shock loads.
- Functions may operate sluggish and not be as responsive, so allow more time and distance when starting and stopping movements.

Hot weather operation above 100 degrees F (38 degrees C) may require intermittent operation to allow the oil to cool or the addition of oil coolers. Do not exceed an oil temperature of 150 degrees F (66 degrees C).

## WIND SPEED

Do not operate the Aerial device or Digger Derrick at any wind speed that would create a potential hazard or does not allow safe operation for the work to be performed.

Allow for platform, boom and work-area movement, electrical line sway or sag during windy conditions.

Always account for windy conditions during the worksite inspection or survey.

**NOTE: OSHA 1910.269 (x) (5) allows the use of Aerial devices and Digger Derricks up to a wind speed of 30 MPH (48 km/h). The OSHA general duty clause also requires the user to determine if conditions are safe before proceeding with work.**

It is both the user's and operator's responsibility to conduct a thorough worksite inspection and determine if the work can be performed and the equipment operated safely in the conditions at the site. It is the responsibility of both the user and operator to also continuously monitor the worksite conditions and if conditions adversely change, to halt all operations until conditions allow for safe operation.



**JOB SITE SETUP**

The unit is tested for stability per ANSI with the vehicle level and must be operated within those guidelines. Because of the effects on stability when the unit is not level, the unit must be in a level position before any boom functions are operated. Level the unit using the level indicators (bulls-eye level) mounted at the outrigger control location when setting the outriggers. Follow instruction in Operators Manual for site selection and outrigger operation



- Determine if the vehicle is level by looking at the level indicator located by the outrigger controls. The operator must visually verify the ground condition and that the outrigger can support the truck weight and boom load that can exceed 25,000 lbs. (11,340 kg).
- Change the position of the truck by repositioning the truck or by cribbing outriggers if the outriggers do not have sufficient stroke to level the truck.



Level truck before operating Boom functions.

**Use the following procedure after the vehicle is in position at the work site:**

- Turn on warning lights.
- Place vehicle in neutral and set brakes before leaving cab.
- Chock the wheels.
- Position and use signs, warning lights, and barricades in accordance with OSHA, ANSI, state, and company rules and regulations.
- When work is to be performed on or near power lines, ground and/or barricade vehicle according to your company policy. If using a temporary ground connect grounding cable clamped to a static line or neutral, or use drive or screw type ground rod to ground truck according to your company policy. Unroll ground cable fully and spread out so cable does not cross over.
- Engage the power take-off (PTO) following the directions given with the specific PTO installed on the truck.
- Turn master switch on to provide electrical power to electrically powered options. (May also function as PTO Switch.)
- Set the outriggers (if equipped).



Failure to level unit properly will affect stability and could cause unit to tip over.



If the unit is equipped with outriggers, all outriggers must be set properly to provide adequate stability.



## SETTING THE OUTRIGGERS

Before lifting or rotating the Aerial Device, all outriggers (if equipped) must be lowered firmly to the ground on a surface that can support the load, and kept there until all work is complete and the Aerial Device is stowed for travel. The stability of the Aerial Device depends on the gross weight of the vehicle, platform and jib load, the slope of the ground in the work area, and whether the ground is firm enough to support the load imposed. The condition of the truck tires, axles, torsion bars, outriggers and outrigger pads or cribbing all contribute to proper stability. These conditions are widely variable, so the operator must exercise good judgment and caution when setting the outriggers before utilization of the Aerial Device.

The method of setting the outriggers will vary depending on the number of outriggers and configuration. If the vehicle is equipped with one set of outriggers, the tires and the spring force of the truck axle work with the outriggers to provide stability. The location of the outriggers relative to the truck axles and the pedestal will determine how much the outriggers can be extended.

When lowering the outriggers:

- Determine if truck is properly parked with brakes applied and wheels chocked.
- Position the outrigger pads and ensure that the surface will support the outrigger force, crib as required.
- Before lowering the outriggers, check the area where the outriggers will extend to ensure no personnel or other objects are in the path. Alert all personnel that the outriggers are being moved and positioned.

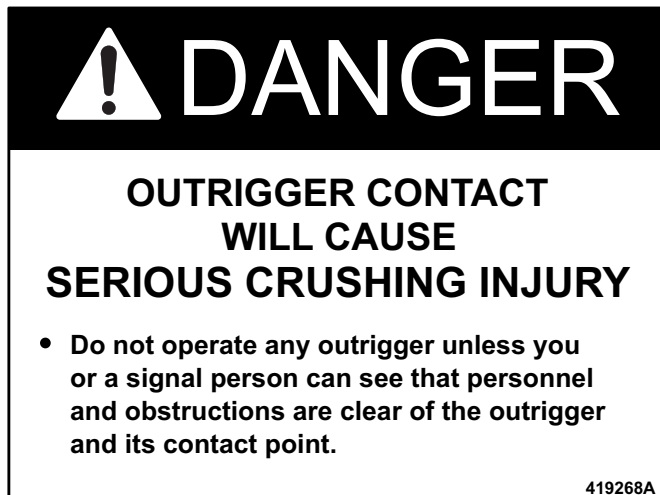

- Units with one set of outriggers behind the rear axles on rear axle mounts, extend the outriggers until the weight of the vehicle is off the springs. Rear tires must remain on the ground. More outrigger extension is allowed the closer the axle is located to the outrigger.
- Units with one set of outriggers between the axles on behind-the-cab mounts, set the outriggers firmly on the ground, but do not raise the weight of the vehicle off the springs. Tires must remain on the ground with the truck suspension providing equal support on each side of each axle.
  - Do not attempt to correct the ground slope with the outriggers; this unloads the low side tires and suspension. The suspension may not provide enough force for stability.
  - After setting the outriggers evaluate the truck position and setup. Determine if the tires are equally supporting the load by looking at the clearance to the fenders, body, or bed and the axle location to the axle stop, (rubber bumper) and overload springs. If one tire is closer to the body and the other tires on the opposite side of the same axle is father away from the body the unit is not set up properly. The spring deflection on each side must be the same or the overload springs or rubber bumper both in contact with their stops. Tires on the low side must be cribbed to equalize the truck suspension load so it can provide the force needed for stability if not equally loaded as parked.





- Two sets of outriggers: The outriggers are extended to support the weight of the unit. The tires should remain in contact with the ground.
  - The vehicle can be leveled slightly with the outriggers.
- The axles not located between the outriggers must equally support the load of the truck so the suspension on each side is equally loaded.
- If the unit is equipped with a lower lift more stringent requirements may be required for proper stability. Refer to decals on the vehicle or manual supplements for proper instructions.
- The chassis brakes will be inoperable if the rear tires are off the ground.
- Tires must be on the ground when operating over the front of the chassis.



**The outrigger moving alarm will sound when the outrigger control is activated. If the alarm does not sound, it must be repaired.**

If the vehicle must be set up across a slope, the surface can be up to 5 degrees from level but must be firm and flat where tires are located. If one side of the vehicle is low, extend the high side outrigger first and make sure that firm contact is made. If full extension does not make firm contact, the outrigger pad must be blocked up. Always chock the wheels. If the slope exceeds 5 degrees before setting the outriggers the tires must also be blocked and cribbed so the truck is parked at less than 5 degrees. If the unit has one set of outriggers do not level the truck with the outriggers. On units with one set of outriggers using the outriggers to level the truck does not change the slope, it reduces the truck suspension's ability to support the load and provide stability.

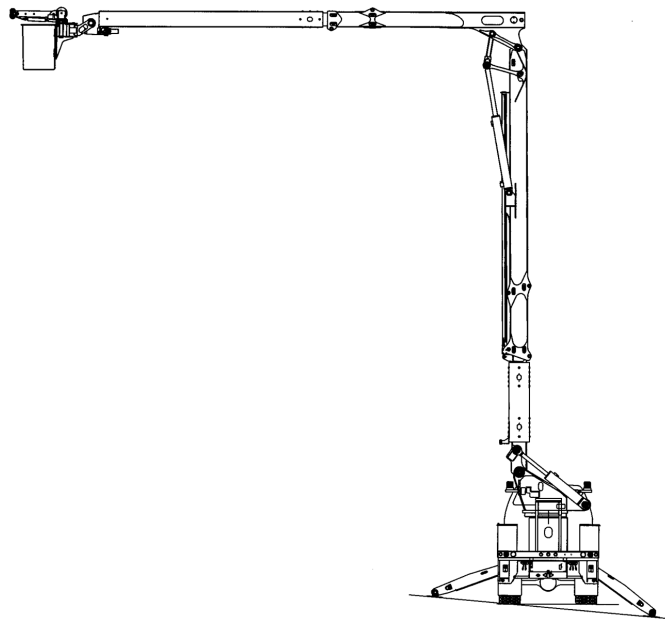

**VEHICLE SETUP ACROSS THE SLOPE**



**Working on slopes where vehicle is not level may result in vehicle tipping over.**



**The truck must be level before operating the booms.**

If the vehicle must be set up with the slope, chock the wheels and work off the rear of the vehicle.

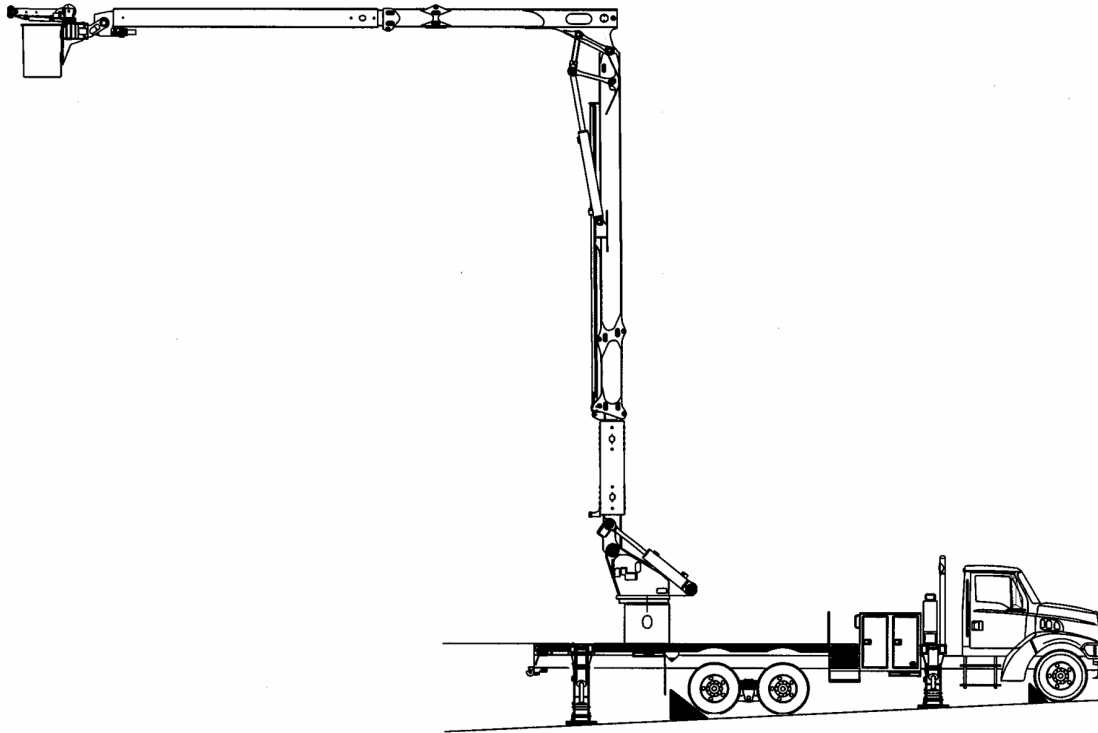

VEHICLE SETUP WITH THE SLOPE



**The truck must be level before operating the booms.**

If the vehicle must be set up where an outrigger extends into a ditch or gutter and the full extension does not make firm contact, the outrigger must be blocked or cribbed up. Chock the wheels carefully to prevent motion of the truck. Ensure cribbing (if required) provides stable support. If the vehicle must be set up so an outrigger rests on a curb with the vehicle in the street, the outrigger span will be shortened and stability is reduced. Ensure the curb has sufficient strength to support the load. All of the previous may affect the stability of the vehicle and restrict the load capacity of the vehicle. Proceed with caution under these conditions. If the outrigger support surface is not level with the truck, the bank may need to be cut away or brought up to a level so the outrigger will provide proper support. The ground must be able to support the load of the outrigger without sinking.

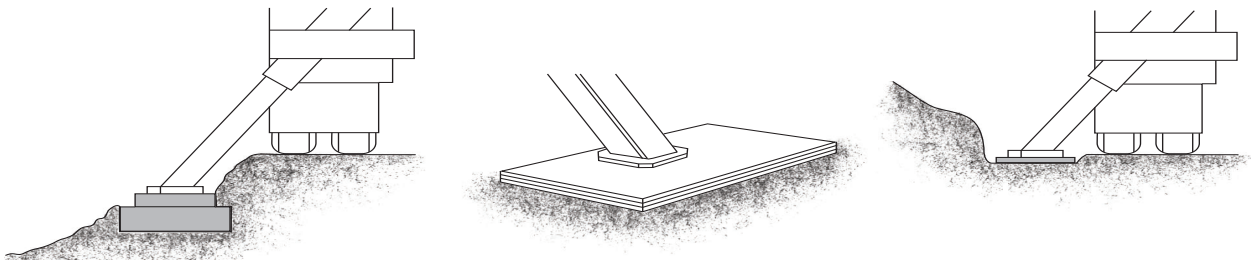

## SETTING UP ON A SOFT SURFACE

If the ground is too soft to support the outrigger load or wheel load, the outriggers or tires must be padded or cribbed until the ground will support the load or the unit cannot be used at that location. Make certain the tires and outriggers are centered on the pads and the cribbing provides stable support as the booms are moved.

## SETTING UP FOR OPERATION ON SNOW AND ICE

Operation on snow and ice adds an additional problem due to the slippery conditions. Normal traction is greatly reduced. Just as you need to maintain traction to walk and drive, it is required to keep Digger Derricks and Aerial Devices in a stable position. Rotating and moving the booms may cause the truck to jerk and move. If the unit is not set up securely the truck can slide on ice and snow while operating. When planning your work remember that driving in snow causes snow dust to be deposited on all surfaces. The outriggers and outrigger pads will get snow covered and slippery. Also, as you put pressure on snow, the snow packs down and turns to ice. The person setting the unit up for operation has the entire responsibility for a stable position. The person on the site is the only one who can evaluate the conditions and terrain.

### Proper set up requires:

- Outriggers do not slide on the outrigger pads during use.
- Outrigger pads do not slide on the ground during use.
- Set the parking brakes.
- Chock wheels as required, to prevent movement down hill. Evaluate chock location to prevent the truck pivoting around one chock.
- Set units with one set of outriggers so all tires are on the ground.
- Evaluate the terrain to determine the most flat and level set up position.
- Set up truck so if the truck does move slightly, the result isn't catastrophic.
- Follow Operators manual for set up instructions. Do not place outriggers on Ice as slippage may occur regardless of solid footing.

### To properly set up you may need to:

- Remove snow and ice down to bare ground to prevent sliding and to evaluate the support available. Don't set outriggers on a manhole cover or the edge of a slope or drop off.
- Move as far as required into the street or road so if the truck does move, the tires and outriggers will not slide into the ditch or other hazards.
- Choose a location for the truck that gives the best stability for the work to be done.
- Come back later, to do the work, if the roads are not cleared sufficiently.
- Use traction aids under the tires and outriggers such as sand and gravel or mats.
- Operate the unit smoothly by "feathering" the controls, not jerking the levers.

## OUTRIGGER INTERLOCK

If the completed unit requires outriggers for stability it will be equipped with Boom Interlock. Boom Interlock will prevent boom operation unless the outriggers are extended. The booms will not operate if the outriggers are not extended past a predetermined point. The operator must ensure the outriggers are set properly to provide stability. If the booms do not operate and the Outrigger/Unit Control Selector is selected to "UNIT" then verify the outriggers are properly extended. The operation of the boom interlock does not assure Aerial Device stability. It only serves to remind the operator that the outriggers have not been deployed.

**STABILITY**

The stability of a vehicle equipped with a rotating aerial device depends on the gross weight of the vehicle and load, the slope of the work area, and whether the ground is firm enough to support the weight of the outrigger pads. These conditions are widely variable, so the operator must exercise good judgement and extreme caution to learn just what their particular vehicle can handle.

**IMPORTANT: Know the loading capacities of your unit under all conditions of load, terrain, and Aerial Device.**



**Keep loads close to the ground until you determine for sure that the load can be balanced safely at the maximum distance you wish to work.**



**Increasing the distance from the vehicle to the load will affect the stability of the Aerial Device. Keep loads close to the ground until you determine that the load can be balanced safely at the maximum distance you wish to work.**



**This Aerial Device has been tested for stability on a flat firm surface with a maximum slope of 5 degrees with the vehicle leveled. Working on slopes that exceed 5 degrees may result in vehicle tipping over.**



**Verify that you have the proper tire pressure stated by the vehicle manufacturer.**

## OPERATION

### BOOM OPERATION

The boom movement is limited to non-overcenter positions by a limit system. Do not depend on the limit system to recognize when the booms are approaching a limit. Operate the unit knowing where the booms and platform are in the work envelope to keep operation in the working area. See the Operational Limit section for complete description.

	<div style="background-color: black; color: white; padding: 5px; text-align: center;"> <h1>! DANGER</h1> </div> <p><b>OVERTURNING HAZARD DEATH OR SERIOUS INJURY</b></p> <p>May result from operating outside the proper platform &amp; boom positions or improper outrigger setup or truck position</p> <ul style="list-style-type: none"> <li>• Platform must remain opposite lower boom hinge pin from lower boom.</li> <li>• Lower boom can only extend when lower boom is above 55 degree angle.</li> <li>• Upper boom can be extended at any time.</li> <li>• All outriggers must be properly set before operation of the booms.</li> <li>• Truck must be level before operation of the booms.</li> </ul> <p style="text-align: right;">475373</p>
--	--

TM105

	<div style="background-color: black; color: white; padding: 5px; text-align: center;"> <h1>! DANGER</h1> </div> <p><b>OVERTURNING HAZARD DEATH OR SERIOUS INJURY</b></p> <p>May result from operating outside the proper platform &amp; boom positions or improper outrigger setup or truck position</p> <ul style="list-style-type: none"> <li>• Platform must remain opposite lower boom hinge pin from lower boom.</li> <li>• Lower boom can only extend when lower boom is above 70 degree angle.</li> <li>• Upper boom can be extended at any time.</li> <li>• All outriggers must be properly set before operation of the booms.</li> <li>• Truck must be level before operation of the booms.</li> </ul> <p style="text-align: right;">488127</p>
--	--

TM125

The limit system will restrict operation of: Upper Boom up, Lower Boom down, Lower Boom Extension out. The other functions are not limited. The Lower Boom Extension is limited to lower boom positions above 55 degrees (TM105) or 70 degrees (TM125). The Upper boom extension is not limited. If the Lower Boom is extended below 55 degrees (TM105) or 70 degrees (TM125), the movements are limited. To operate fully retract the Lower Boom Extension and the system will reset in a few seconds.

The platform will not be able to operate on the same side of the centerline of rotation as the elbow. If the platform approaches the centerline the boom function will stop.

When the upper boom up or the lower boom down motion is stopped by the limit valves it may be necessary to lower the upper boom or raise the lower boom slightly to reset the valves.

All boom movements should be smooth. Avoid jerking by slowly metering the control valves when starting and stopping all motions. Be aware of the elbow and boom positions to prevent contact. Start and stop all boom movements by "feathering" the controls for smooth operation. Lift the upper boom then the lower boom off the rest and elevate it high enough to clear all body obstructions before rotating. This Aerial Device is equipped with a collector block oil distribution center in the turntable, which permits the continuous rotation of the boom in either direction without stops.



**Make certain that all personnel are in the clear and that there is sufficient overhead clearance before operating the Aerial Device.**

The Platform can be brought to ground level for loading and unloading. Raise the Upper Boom enough to clear then raise the Lower Boom. By extending the Upper Boom Extension you can bring the platform to ground level. It is recommended that this position be used to load tools, equipment, and for normal operator entry.

### **UNSTORE THE BOOM**

Before attempting to raise the booms, remove all boom hold down straps. Ensure area overhead is clear and raise upper boom before raising lower boom. Raise booms sufficiently to clear all obstructions before rotating.



### AERIAL OPERATION

Before using the Aerial Device, the operator should check through the pre-operational procedure to ensure the vehicle is properly positioned with outriggers (if equipped) firmly in place. Extreme care should always be exercised when lifting personnel.

Before entering the platform, place the outrigger control selector (if equipped) and the lower control selector to the upper controls.

### ENTERING THE PLATFORM

Use steps and handhold's for safe access to the platform. Each person will have different methods of entering based on there physical attributes. Once at the platform use the top lip as a handhold when getting into platform. There are several step options both inside and outside the platform, if needed such as liners with steps, hanging steps, or scuff pads for the platform or liner with steps. Do not locate or hang tools, tool bag, or equipment that will interfere with safe access.



**When entering or exiting the platform be aware of where your lanyard is to prevent tangling with your feet or legs causing tripping.**

After entering the platform, connect the lanyard to the attachment ring located on the platform bracket. An OSHA Approved Fall Arrest System must be used.

The indicated number of lanyards may be attached to the lanyard anchor provided, one or two as indicated by X1 or X2 on decals.

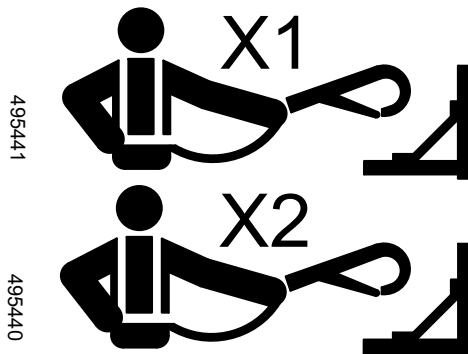

DANGER

READ CAREFULLY

- OCCUPANTS OF THE BASKETS OF THIS AERIAL DEVICE HAVE ABSOLUTELY NO ELECTRICAL PROTECTION FROM CONTACT BY THE HUMAN BODY WITH TWO ENERGIZED CONDUCTORS OR BETWEEN AN ENERGIZED CONDUCTOR AND A GROUNDED CONDUCTOR.
- It makes no difference if this contact is accidental or deliberate or whether contact is made through metallic parts of the basket, basket support, metal tools or equipment brought into the basket. The insulating components of this aerial device do not offer protection in the event of such contact.
- Proper conductor cover up, insulated sleeves and gloves shall be worn when working near energized lines or equipment.

DEATH OR SERIOUS INJURY  
WILL RESULT FROM SUCH CONTACT  
OR INADEQUATE CLEARANCE

414590A



<p><b>! DANGER</b></p>	
<p><b>FALLING FROM PLATFORM WILL RESULT IN DEATH OR SERIOUS INJURY</b></p> <ul style="list-style-type: none"> <li>• Platform personnel must wear an OSHA approved fall protection system with lanyard attached to anchor provided.</li> <li>• Platform doors, if provided, must be securely latched.</li> </ul>	

419264A

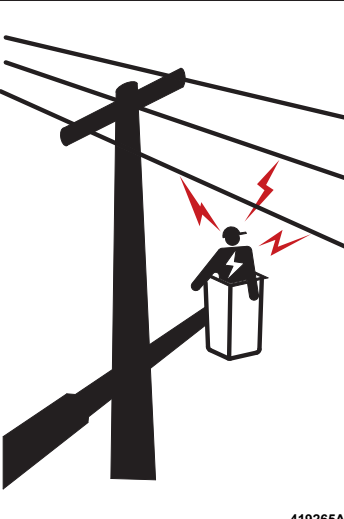
<p><b>! DANGER</b></p>	
<p><b>ELECTROCUTION HAZARD THIS MACHINE IS NOT INSULATED DEATH OR SERIOUS INJURY</b></p> <p>Will result from contact with or inadequate clearance to electrical power lines and apparatus</p> <ul style="list-style-type: none"> <li>• Maintain safe clearance from electrical power lines in accordance with applicable government regulations. Allow for boom, platform, electrical line and load line sway.</li> <li>• This machine does not provide protection from contact with or proximity to an electrically charged power line.</li> <li>• Boom and platform must be kept below all electric power lines.</li> <li>• Do not use for work on electric power lines.</li> </ul>	

419265A

 <p>ARROWS BOOM TIP (ALL PARTS PAST ARROWS)</p>	<p><b>! DANGER</b></p>
<p><b>ELECTROCUTION HAZARD</b></p> <p><b>CONTROLS ARE NOT INSULATED OR ISOLATED</b></p> <p>All metal at boom tip is electrically connected. Operator contact with ANY, live or grounded, line or object while operator touches <b>CONTROLS</b> or <b>BOOM TIP COMPONENTS</b> and boom tip contacts any other line or object can result in</p> <p style="text-align: center;"><b>DEATH OR SERIOUS INJURY</b></p> <p>Comply with OSHA, ANSI, &amp; NESC requirements</p> <ul style="list-style-type: none"> <li>• Maintain proper CLEARANCE to all lines and objects</li> <li>• Wear Personal Protective Equipment: Fall protection; Eye protection; Insulating: gloves, sleeves, and hard hat; &amp; Special clothing</li> <li>• Cover all lines with insulated line hose or insulating blankets</li> <li>• <b>DO NOT</b> Depend on machine covers for insulation</li> </ul> <p>Plastic or fiberglass covers offer limited electrical insulation. Covers are <b>NOT</b> tested, certified, or maintained as insulating.</p>	

463602A

	<p><b>Do not allow any part of the Aerial Device to come in contact with any electrical conductors, either energized or non-energized.</b></p>
---	--





Use protective equipment suitable for the work being performed:

Follow your employer’s policies for personal protective equipment. Failure to wear proper PPE can result in death or serious injury.

- Wear insulating gloves and sleeves when working on or near electrical equipment.
- Install hose, covers, and mats on all energized and grounded conductors.
- Wear protective and insulating headgear.
- Use a platform liner.

	<b>Do not move the vehicle with personnel in the platform. This Aerial Device is not designed for this type of operation. All passengers must be seated in vehicle according to manufacturer’s designated positions.</b>
---	--

Study the movements required to reach the work location. Use a feathering technique with control levers to ease the Aerial Device to smooth starts and stops. Use low speeds, when approaching the aerial job site. Use high speed only between ground and job site and job site and ground. Always look in the direction the Aerial Device is traveling to be certain there is clearance for the boom(s), platform, and operator.

Be aware of any obstacles the lower boom may strike if rotated or elevated, and any objects that the booms may come close to as movements are made.

If equipped with engine throttle control, use low engine speed if extended time will be spent at one site.

	<b>Do not leave the platform to build trestles between the platform and another work location.</b>
---	--

	<b>Avoid careless handling of tools and equipment while aloft. Use a tool tray to help prevent dropping items. Keep all ground personnel away from the area directly under the work point unless absolutely necessary, and caution them that it is necessary to be constantly on the alert for possible falling items.</b>
---	--

	<b>Use orange hose marked NON-CONDUCTIVE for tool hoses, at the boom tip, and areas that bridge the insulation gap.</b>
---	---

	<b>Do not let hoses hang where they can catch on or contact energized conductors or grounded conductors on any structure.</b>
---	---

	<p><b>The Aerial Device upper control station has metallic parts, which are necessary to provide the structural support for the various components. These metallic parts are interconnected. The main shaft that supports the platform and controls must also support other load carrying options that can be added to the boom tip.</b></p> <p><b>The fiberglass upper and lower boom, in a well maintained condition, provides electrical insulation between the boom tip and the truck as a potential to ground. This fiberglass will not protect the operator in the platform if any portion of the boom tip, including options, is brought into contact with an energized or non-energized conductor and the operator is in contact with a different potential, such as, a grounded non-energized conductor. This type of contact can energize or ground the controls because as stated before, all components of the boom tip are interconnected. The fiberglass will not provide protection for the operator in phase to phase contact or a phase to ground contact, nor will it protect the vehicle from becoming energized if the steel boom section below the lower boom insert, if so equipped, is brought into contact with an energized conductor.</b></p>
---	---

	<b>Do not depend on Aerial Device covers for insulation. Plastic or fiberglass covers offer limited electrical insulation. Covers are not tested, certified or maintained as insulating.</b>
---	--



## EMERGENCY OPERATION

Emergency operation may be required if an operator is injured or the equipment malfunctions. In any emergency, the first priority is always the safety of the personnel involved. It is always important to remember to follow the standard work practices and the safety regulations that apply. If the Aerial Device is operable, move the platform away from the danger and into the shortest, clear path of descent to get the operator on the ground. If the Aerial Device is inoperable, consider using another Aerial Device to rescue the operator from the platform. If an equipment defect is suspected, do not allow anyone to enter the platform. Instead if the situation allows safe operation from the lower controls, override the upper controls and carefully lower the platform to the ground. Operate only one lower control at a time when overriding the upper control.

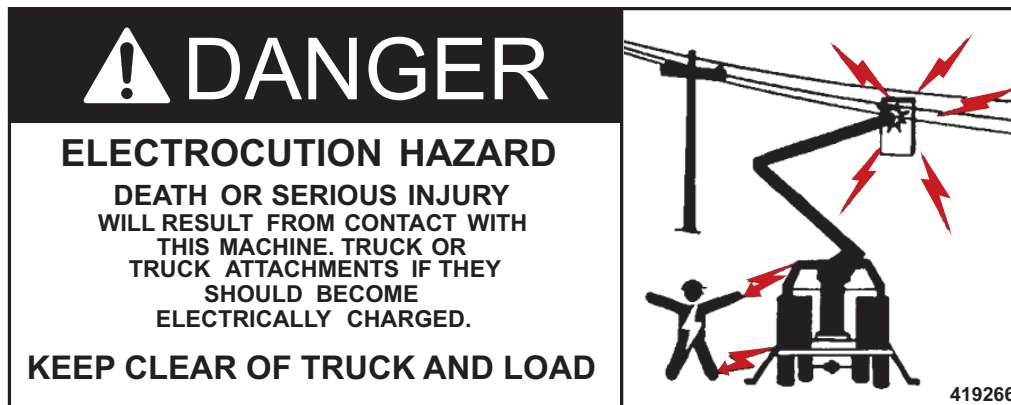

**Do not touch the truck or attachments and the ground at the same time. If the truck, including Aerial Device or any attachment connected to the truck, contacts a power line, you will be a path for the current. Death or serious injury will result.**

## POWER LINE CONTACT ON GROUND VEHICLE IS TOUCHING A POWER LINE

Take these steps if your vehicle makes contact with a live power line while you are in or on the vehicle:

- Treat any line, as live unless you know for sure it is not.
- Stay inside or on the vehicle until the power is disconnected or turned off.
- Warn others to stay away from the vehicle and any trailers or attachments.
- If you must get away from the vehicle because of fire or other danger:
  - Jump out and away from vehicle.
  - Do not touch the vehicle and ground at the same time.
  - Land with your feet close together.
  - Shuffle away taking very small steps keeping feet together.
  - Do not try to help others out of the vehicle, you could get electrocuted.

### STANDING ON GROUND CLOSE TO FALLEN POWER LINE

You must shuffle keeping feet together, do not run. The voltage is highest where contact is made and decreases as you get farther away from the point of contact. The distance will depend on the ground conditions and conductivity of the ground. If you run, your legs will bridge from higher to lower voltage and current will pass through your feet and legs. Keep your feet together and shuffle to go from one voltage gradient to the next gradually. This will decrease the chance of electrocution as you move away from the vehicle or fallen wire.

- Never touch a fallen power line unless you are trained and properly equipped to handle it safely.
- Shuffle away using very small steps keeping feet together; do not run.
- Do not touch anything as you leave the area.
- Warn other people to stay away from the area.
- Immediately notify the proper authorities or people to correct the problem.



**In an electrical emergency: Stay calm and think before you act. Don't become a victim while helping someone else.**

### APPROACHING A VEHICLE THAT MAY BE ENERGIZED

In an emergency situation, it may be necessary for ground personnel to operate the Aerial Device. The entire vehicle and any attachments must be considered energized any time the booms are in the vicinity of power lines.



**Operators make sure your ground personnel know the proper operation and emergency procedures for the Aerial Device. Your life may depend on it if you have an accident or are incapacitated.**

If you must approach a vehicle to perform a rescue operation, understand and follow your company policy. It will take precedence over these instructions. You must be very careful not to touch the vehicle and the ground at the same time or your body will be in a circuit and current may pass from foot to foot or foot to hand. The condition of the ground and subsurface will determine the electric gradient around the vehicle.

**BEFORE TRYING TO GET ON OR APPROACH THE VEHICLE:**

- Is it necessary to approach the vehicle? Can the operator handle the problem from the platform?
- The best procedure is to disconnect or shut off the power to the lines.
- Do not let anyone approach the vehicle until you evaluate where the power line contacts the Aerial Device.
  - Is it above the insulated section of the upper boom?
  - Is it above the lower boom insulated section?
  - Is it below any insulated sections and a direct short to the vehicle?
- If the vehicle is grounded properly:
  - Use a hot stick or hot line tool to perform the operation.
  - Approach the vehicle using the shuffling step.
  - Lay a rubber blanket down by the vehicle and step on it before attempting to jump on the vehicle.
  - Do not touch the ground and the vehicle at the same time. Even a properly grounded vehicle may have a lethal voltage difference between the truck and ground.
- If the vehicle is not grounded:
  - Do not approach the vehicle unless you use insulated blankets to step on as you approach the vehicle. Stepping from one rubber blanket to the next.
  - Use a hot stick or hot line tool to perform the rescue operation while standing on the rubber blanket.
  - As a last resort, jump onto the vehicle.
  - Do not touch the ground and the vehicle at the same time.

**TOP CONTROL SHUT-OFF**

When a situation requires the upper controls be overridden (such as, injured personnel in the platform), use the Top Control shut-off at the lower controls to stop oil flow to the boom tip. This will make the upper controls inoperable. Then “lower” controls can be used to lower the operator to the ground, provided the upper controls are intact. The Top Control shut-off functions as an emergency stop by taking oil flow away from the platform controls. Operate only one lower control at a time when overriding the upper control.

If the operator is unable to operate the Aerial Device, determine if any damage has occurred to make the Aerial Device inoperable. If the situation allows safe operation from the lower controls, override the upper controls and carefully lower the platform to the ground. If the Aerial Device will not operate due to the damage incurred, consider one of the other auxiliary operating procedures presented in this section to solve the problem.

If the top controls are not activated but operator is incapacitated, leave the top control shut off in upper control position so leveling will be operable. When hydraulic flow is stopped to the platform the leveling will not function. The operator at the lower controls must manually level the platform as the booms are moved.



### AUXILIARY LET DOWN POWER (OPTIONAL)

The auxiliary let down power system provides power from a DC motor-pump for operation of the Aerial Device in case of a prime power source failure. Controls for auxiliary let down power may be located at the platform, pedestal (optional), and outriggers (optional).

At the platform, the auxiliary let down power is operated by a fiber optic switch, located with the upper controls. To activate this system, push and hold the “Auxiliary Power” push button then operate the controls. The pump will engage after a 10 seconds delay. To turn “off” the power, release the “Auxiliary Power” push button. The Auxiliary Let Down Power system should not be continuously operated longer than 30 seconds. Continuous use will drain the battery and damage (overheat) the motor.

At the pedestal and the outrigger controls (if equipped), the auxiliary let down power is operated by a push button switch. To activate this system, push and hold the switch, the pump will engage after a 10 seconds delay. To turn “off” the power, release the switch. The Auxiliary Let Down Power system should not be continuously operated any longer than 30 seconds. Continuous use will drain the battery and damage (overheat) the motor.

Do not use the let down pump as an auxiliary pump. Use the let down pump only to lower the booms and/or raise the outriggers when either the main pump or engine malfunctions. Using the pump to raise the booms may cause damage to the let down pump motor.

When the Aerial Device is equipped with engine two-speed throttle and auxiliary let down power, the same control is used for both. When the engine is running, the engine two-speed throttle operates. When the engine is off, the auxiliary let down power operates.

### MANUAL LET DOWN SYSTEM

If all power is lost, use the Manual Let Down System, (see operation instructions) to lower the platform using gravity. The aerial device may be lowered and the rotation system can be manually powered using a 7/8” gear wrench to get the platform down. Each situation will vary, so the ground personnel must carefully think through what actions are required to lower the platform. Once a function is lowered, it cannot go back up without hydraulic power. The platform will not level when using the manual let down system. After lowering the unit manually, cycle the unit to remove air from the hydraulic system before operation from the platform.



**No interlocks or boom limits function when using the Manual Let Down. Operator must keep boom in operational limits by retracting lower boom before lowering lower boom.**

### MANUAL ROTATION

If all the hydraulic power sources become inoperable, the Aerial Device rotation system can be actuated manually. Use a 7/8 in. hex socket, an extension, and a ratchet to rotate the input shaft on the gearbox. Actuating the lower rotation control will reduce the effort required for the rotation.

## HYDRAULIC LINE FAILURE

Hydraulic line failure during Aerial Device operation presents numerous hazards. Be aware that a hydraulic oil mist caused by a leak or hydraulic line failure is conductive even though nonconducting oil is used.



**A spray or mist produced by a hydraulic leak under pressure is very hazardous to personnel. This spray or mist can puncture the skin or become embedded beneath the skin. This condition would require immediate medical attention.**

**WARNING**

Escaping fluid under pressure can penetrate skin causing serious injury.

Relieve pressure before disconnecting hydraulic lines. Keep away from leaks and pin holes. Use a piece of cardboard or paper to search for leaks. Do not use your hand.

Fluid injected into skin must be surgically removed within a few hours by a doctor familiar with this type injury or gangrene will result.

H23877A

### WHAT CAN CAUSE A HYDRAULIC LINE TO FAIL?

- Poorly maintained hydraulic system.
- Improperly assembled and installed hydraulic lines.
- Weather checked hose assemblies.
- Hydraulic tool hoses that are allowed to cross phase to phase or phase to ground.
- Boom contact with phases causing a short circuit, which overheats the hydraulic line.
- Improper system pressure setting.
- Overheating the hydraulic system.
- Snagging of hydraulic lines on fixed objects.



### WHAT CAN HAPPEN WHEN HYDRAULIC LINES FAIL?

Hydraulic oil, when confined within the hydraulic system and properly maintained, is non-conductive and not subject to being ignited. There are numerous hazards that develop when there is a hydraulic line separation:

- Personnel may suffer burns from contact with hot oil.
- A vacuum may be created in the line and breach the insulated portion of the booms causing the Aerial Device to be conductive.
- If the hydraulic line failure creates a mist of oil, it very easily can be ignited by any outside source of ignition; such as, electric arcing, sparks, and flames.
- The reservoir may be drained of oil, which will make the Aerial Device inoperable.

### WHAT TO DO IF HYDRAULIC LINES FAILS?

A quick response to stop oil flow caused by a hydraulic line failure is important to prevent further damage and prevent injury.

The following sequence can be used to stop the flow.

From The Platform

- Release the function being operated. Shut off tool valve if tool, tool hoses, or tool connections are involved.
- Activate the stop control, which will divert the flow back to the tank.
- Activate the engine stop/start switch, if so equipped. This will stop the engine driving the pump.
- Get ground assistance if all these fail.



**The vehicle may be energized. If mounting or operating the vehicle from the ground, use proper personal protective equipment; such as rubber gloves, rubber boots, rubber mats, and/or a hot stick. See Emergency Operation section for procedure to approach vehicle.**

From The Vehicle Bed

- Move the control selector at the lower controls to the lower control position. This will stop all flow to upper controls.
- Push the engine stop/start switch, if so equipped. This will stop the engine driving the pump.

From The Ground

- Shut off the pump engine. This will stop the pump.
- Disengage the power take-off. This will stop the pump.
- Move the control selector at the outrigger control valve to the outrigger position. This will stop all flow to the Aerial Device and send it to the outrigger circuit.
- Push the engine stop/start, if so equipped. This will stop the engine driving the pump.

Once the flow is stopped, determine where the line failure is located. The following examples describe some emergency procedures that can be followed for some specific types of hydraulic line failures:

- If the line failure is between the upper and lower controls, overriding the upper controls and only operating from the lower controls may reduce the rate of hydraulic oil loss. The intermittent loss of hydraulic oil may allow the Aerial Device to be stored.
- It may be necessary to use another Aerial Device to bring the operator down.

**NOTE: Oil spills may require notifying Local, State, or Federal Authorities.**



**The Aerial Device must not be operated until repairs have been completed and the Aerial Device cycled from the lower controls to purge air.**

## ENGINE FAILURE



If the prime power source fails, the optional auxiliary let down power system can be used for emergency operation. If the auxiliary let down power system is not installed and the vehicle has a manual transmission, then use the engine stop/start control (if so equipped) to crank the engine.

## HYDRAULIC PUMP FAILURE

If the primary hydraulic pump fails, use the auxiliary let down power system, if equipped.

## CONTROL VALVE FAILURE

A control valve malfunction could develop in either the individual control levers or the multifunction single stick control.

If the Aerial Device motion cannot be stopped because the control valve will not return to the centered or neutral position, activate the emergency stop mode by pushing down the emergency stop. The emergency stop position will disable the boom controls, which will stop the Aerial Device's motion. If the engine stop/start control is installed, shut off the engine. The engine and the Aerial Device's motion will cease. Then manually attempt to center the spring-loaded control lever before restarting the engine. If the spring-loaded control lever at the platform will not return to neutral, the Aerial Device can be returned to a stowed position by overriding the upper controls from the lower controls.

After any emergency situation, it is the operator's responsibility to notify appropriate maintenance personnel to make sure the Aerial Device is repaired and adjusted.

Identifying the problem and initiating the recommended emergency procedures will help to minimize or possibly prevent injuries.







## OPERATIONAL LIMITATIONS

### PLATFORM LEVELING SYSTEM

The platform leveling system is designed to carry the rated load of the platform. Collision of the platform(s) with a fixed object, including the ground, or attachment of any load lifting devices to the platform(s) can damage or break the leveling system, causing the platform to be overturned. Avoidance of these hazards and use of OSHA approved fall arrest system for all personnel in the platform is essential for protection against this type of accident.

- 

**Do not allow booms or platform to make contact with fixed objects including the ground. Look for possible contact of booms or platform with fixed objects if you feel the platform is not staying level.**
- 

**The platform leveling mechanism is designed to carry the rated platform capacity, applied standing over the center of the platform floor, and the jib load. Hoisting of material from the outer edge of the platform, from a pole attached to and extending over the top of the platform, places excessive loads on the leveling mechanism. This procedure could cause overturning of the platform(s) and ejection of personnel.**
- 

**This unit is a non-overcenter unit and must be operated in the operational range described in the limit system.**

### PLATFORM LEVELING SYSTEM WITHOUT GENERATOR

This is a battery powered system which requires routine battery replacement. The battery should be exchanged monthly or sooner if the “Low Battery” alarm sounds during operation. A replacement battery is located in the truck cab with a re charge connection. To replace the battery, open the battery box located on the backside of the platform, disconnect the discharged battery at the quick connect and replace with the fully charged battery. Connect the discharged battery to the charger in the truck cab.



### PLATFORM LEVELING SYSTEM WITH GENERATOR

This system operates on a 12 volt battery which is charged by an onboard generator. Routine service of this battery is not necessary. If the low battery indicator light turns on, replace the battery located beneath the servo and/or check the generator for proper operation.

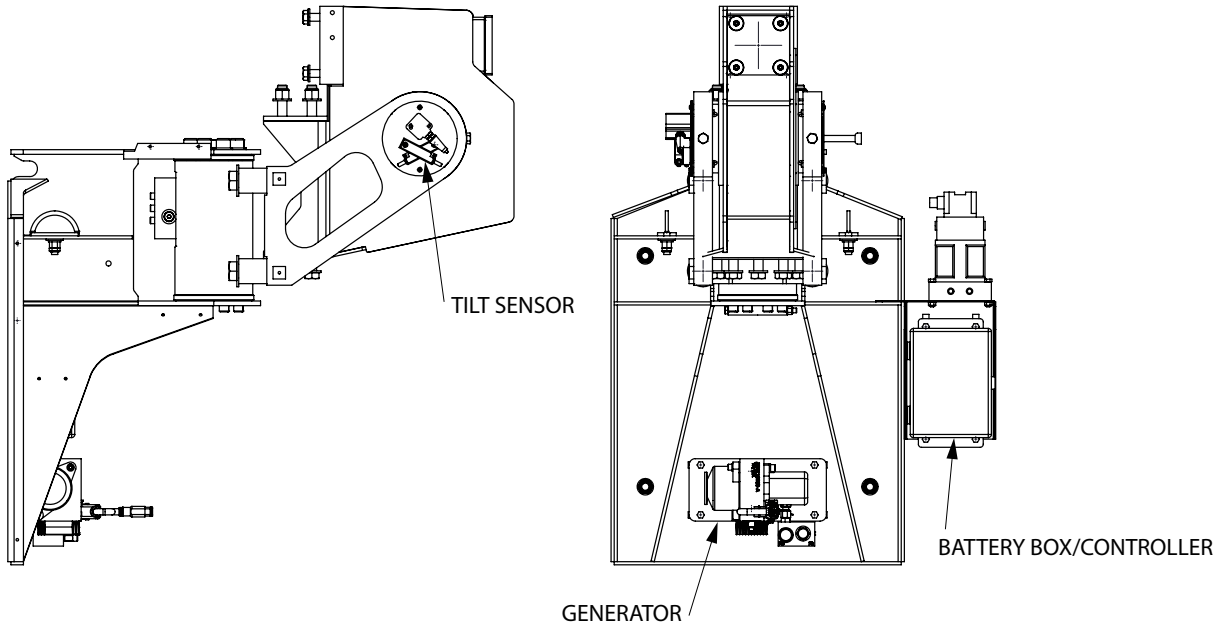

**LIMIT SYSTEM (OPERATIONAL RANGE)**

The TM Series is a non-overcenter Aerial Device. It operates with the platform opposite the centerline of rotation from the lower boom at all times. If the platform moves toward the elbow side the machine may become unstable and overturn to the elbow side. There are three limit systems that aid the operator to remain in a safe operating position. The operator should not depend on these limit systems. The operator must be aware of where the booms and platform are at all times and operate only in the permissible range.

The boom movements are restricted so:

- You cannot extend the lower boom below 55 degrees (TM105) or 70 degrees (TM125) lower boom angle.
- The platform will stop over the turntable.
- The upper boom will not go above 78 degrees.

	<p><b>⚠ DANGER</b></p> <p><b>OVERTURNING HAZARD DEATH OR SERIOUS INJURY</b></p> <p>May result from operating outside the proper platform &amp; boom positions or improper outrigger setup or truck position</p> <ul style="list-style-type: none"> <li>• Platform must remain opposite lower boom hinge pin from lower boom.</li> <li>• Lower boom can only extend when lower boom is above 55 degree angle.</li> <li>• Upper boom can be extended at any time.</li> <li>• All outriggers must be properly set before operation of the booms.</li> <li>• Truck must be level before operation of the booms.</li> </ul> <p>475373</p>
--	--

**TM105**

	<p><b>⚠ DANGER</b></p> <p><b>OVERTURNING HAZARD DEATH OR SERIOUS INJURY</b></p> <p>May result from operating outside the proper platform &amp; boom positions or improper outrigger setup or truck position</p> <ul style="list-style-type: none"> <li>• Platform must remain opposite lower boom hinge pin from lower boom.</li> <li>• Lower boom can only extend when lower boom is above 70 degree angle.</li> <li>• Upper boom can be extended at any time.</li> <li>• All outriggers must be properly set before operation of the booms.</li> <li>• Truck must be level before operation of the booms.</li> </ul> <p>488127</p>
--	--

**TM125**

The limit systems control the following boom movements:

- Lower Boom Extension out
- Lower Boom down
- Upper Boom up

Preventing these three movements keeps the boom from going into a more unstable position toward the elbow side. It is accomplished with valves at various locations that work together to prevent the unit from getting into unstable conditions. This system limits the boom extension in conjunction with the position and angle of the boom.

### UNITS WITH LIMITING VALVE MOUNTED INSIDE THE LOWER BOOM

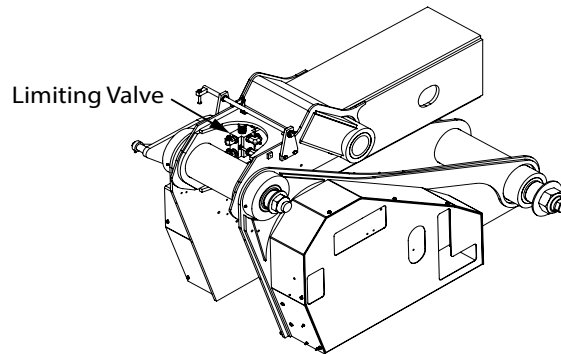

If you move a boom to go over-center the system will move the opposite boom to prevent going to the elbow side with the platform. Example if you raise the upper boom and it gets near the centerline of rotation the lower boom will begin to raise and the platform will raise. Likewise if you lower the lower boom and the platform gets close to the centerline of rotation the upper boom will go down along the centerline. Do not use this feature in normal operation. It is intended only to prevent going to an over-center position.

### UNITS WITH LIMITING VALVE MOUNTED OUTSIDE THE LOWER BOOM

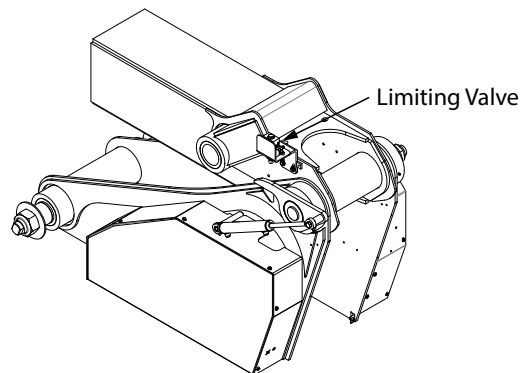

If you move the boom to go over-center the system will stop boom movement to prevent going to the elbow side with the platform. Example if you raise the upper boom and it gets near the centerline of rotation the upper boom will stop raising. Likewise if you lower the lower boom and the platform gets close to the centerline of rotation the lower boom will stop lowering. Do not use this feature in normal operation. It is intended only to prevent going to an over-center position.

If the lower boom is extended with the Lower Boom below 55 degrees (TM105) or 70 degrees (TM125) the extension will stop and Upper Boom up, and Lower Boom down will not function.

To correct the operation if the boom position gets into a limit situation reverse the function and then operate normally. It may take a few seconds for the hydraulic system to reset after an out of limit condition.

### USE OF CATEGORY A UNITS

Category A units must have the metal components at the boom tip bonded. When using Category A units for rubber glove and hot stick work remove the bonding cable from the control areas.



**Category A units require bonding all metal at the boom tip. Remove if using for Category B or C work. Reconnect when using as Category A, bare hand, unit.**

## FALL ARREST

Fall arrest is required whenever in an aerial or digger derrick platform. An OSHA compliant fall arrest system with the lanyard attached to the provided anchor at the boom tip must be used. The issue is not falling from the platform; but being ejected. You can be ejected by failure of a component causing unexpected motion, sudden release of energy from catching or snagging and releasing, or an external force on the vehicle, boom or boom tip.

## RESPONSE TO A FALL

ANSI and OSHA state that no more than 6 minutes should pass from the time a worker falls to when he is reached. These time limits are to mitigate the risks of unconsciousness or further injury of the suspended worker. Each company must have a rescue plan in place to recover a suspended worker. Practice the rescue plan with all workers including the ground persons in this training, who may be the only ones available to perform the rescue. Train all employees to follow your rescue plan to recover the fallen person as quickly as safely possible without endangering the rescue personnel. Determine whether first aid is required as quickly as possible. Notify emergency services if the worker needs to be transported to the hospital according to your companies policies. One of the dangers of being suspended in a safety harness is suspension trauma (orthostatic intolerance). Immobile workers suspended in their harness may lead to fainting or an unconscious state. Depending on the length of time, anywhere from few minutes to about 20 minutes, the suspended worker may become unconscious and depending on the level of venous pooling, the result may lead to death. Because the person will have limited ability to move their legs, blood will pool and not be available for circulation to the other parts of the body and brain. Communicate with the fallen worker to encourage them to move their arms and legs to promote blood circulation to the extremities. If the worker has signs of physical injury, or signs of suspension trauma such as; dizziness, fainting, nausea, sweating, paleness, hot flashes, increased heart rate, breathlessness, unusually low heart rate, unusually low blood pressure, or loss of vision contact emergency medical services immediately. A dangerous condition that sometimes occurs with suspension trauma is compartment syndrome. Also watch the fallen person carefully after rescue. A condition known as Reflow Syndrome can occur. The return of pooled, hypoxic blood and its metabolic byproducts from the extremities to the heart can cause medical issues even after rescue. Refer to your safety department, rescue plan, or local health providers for more information.

## FOLDING FOR TRAVEL



**Do not travel with tools or other items stored in the platform. Loose items may damage the platform or fall on the roadway during road travel.**

It is essential to follow the correct procedure whenever booms are folded for travel:

- Rotate the platform to its stowed position along side the boom.
- Position the jib parallel to the upper boom (if equipped) and fully retracted.
- Fold the lower boom into the rest, making certain that the boom is accurately centered over the boom rest before lowering into position. Apply slight down pressure to hold the lower boom against the rest and prevent bouncing during travel.
- After lower boom is lowered into the rest, fold the upper boom completely against the lower boom.
- Lock upper boom into the rest with the hold-down device
- Lock lower boom into the lower boom rest if a hold-down device is provided.



**The upper boom must be completely secured in its saddle before travel. If the boom is allowed to bounce in its saddle, the fiberglass may craze, shatter and eventually buckle.**

## LEAVING THE JOB SITE

- Place upper and lower boom in stored position for traveling.
- Remove all tools and supplies from platform.
- Position the platform cover in place if one is supplied or ensure platform liner is held in platform.
- Lock upper boom in place with hold down latch or strap.



**The upper boom must be completely secured in its saddle before travel. If the boom is allowed to bounce in its saddle, the fiberglass may craze, shatter, and eventually buckle.**

- Make sure that outriggers are fully retracted.
- Store outrigger pads and wheel chocks.
- Stow all loose tools and equipment.
- Turn off vehicle warning lights.



**Do not travel with tools or other items stored in the platform. Loose items may damage the platform or fall on the roadway during road travel.**

- To prevent damage be sure that PTO is disengaged before traveling.
- Remember the overall height of the unit.
- All personnel need to be in cab of truck while traveling.

**NOTE: If any problems were encountered during working operation, report them to the proper person(s) for maintenance and repair.**

**DRIVE CAREFULLY!**



## SECTION 2

# MAINTENANCE GUIDELINES

### PREVENTATIVE MAINTENANCE

A preventative maintenance program based on the manufacturer's recommendations shall be established. Dated and detailed inspection and repair records shall be maintained.

	<p><b>Failure to inspect and maintain equipment endangers operators and crew. Not performing inspections and maintenance is false economy.</b></p>
---	--

It is recommended that the replacement parts for your Aerial Device be obtained from a Terex South Dakota, Inc. distributor or Terex South Dakota, Inc.

### MAINTENANCE PROCEDURE

Before maintenance, adjustments, and repairs are started the following precautions shall be taken as applicable:

- You must be authorized by owner to operate unit.
- Place vehicle where it will cause the least interference with other equipment or operations in the area.
- All controls at the off position.
- Starting means rendered inoperative.
- Warning or "OUT OF ORDER" signs placed on the vehicle.
- Power plant stopped or disconnected at power takeoff.
- Relax all hydraulic cylinders used for boom lift and articulation.
- Relieve hydraulic oil pressure from all hydraulic circuits before loosening or removing hydraulic components.

After adjustments and repairs have been made, the Aerial Device shall not be operated until all guards have been reinstalled, trapped air removed from hydraulic system, safety devices reactivated, and maintenance equipment removed.

Warning or "OUT OF ORDER" signs shall be placed and removed by authorized personnel only.

### ADJUSTMENTS AND REPAIRS

Any unsafe conditions disclosed by the inspection requirements of this section shall be corrected before operation of the Aerial Device is resumed. Adjustments and repairs shall be done only by qualified personnel.

Adjustments shall be maintained to assure correct functioning of components. The following are examples:

- All functional operating mechanisms.
- Safety devices.
- Control systems.
- Power plants.

Repairs or replacements shall be provided promptly as needed for safe operation. The following are examples:

- All critical parts of functional operating mechanisms which are cracked, broken, corroded, bent or excessively worn. This is for all parts of the Aerial Device, pedestal, subframe, outrigger, and attachments to the vehicle.
- All critical parts of the vehicle structure which are cracked, bent, broken or excessively corroded.
- Hooks showing defects disclosed by "Frequent Inspection" requirements in the maintenance manual shall be discarded. Field repairs by welding or re-shaping shall not be permitted.



All replacement parts or repairs shall have at least the original safety factor. Do not alter, modify, remove or replace any part of the Aerial Device without the approval of the manufacturer.

**NOTE: Do not use hoses having less than 3000 PSI (20.69 MPa) working pressure. Only use orange hoses marked "Non-Conductive" for hydraulic tools, at the boom tip and in areas that bridge the insulation gap.**

**LUBRICATION**

All moving parts of the Aerial Device and vehicle, for which lubrication is specified, shall be regularly lubricated. Lubricating systems shall be checked for proper delivery of lubricant. Particular care should be taken to follow manufacturer's recommendations as to points and frequency of lubrication, maintenance of lubricant levels and types of lubricant to be used.

The preferred lubes are listed in the lube chart. The following are acceptable for the Aerial Device:

1. Gun Grease: Lithium, Sodium, or Calcium base with EP additives, with no more than 5% molybdenum or graphite filled white grease. Do not use fluorocarbon based lubricants or zinc oxide filled white grease.
2. Gear Grease: If Mobil EP023 is not available, EP85W-140 can be used. More seal leakage may result because of thinner consistency.

Machinery shall be stationary while lubricants are being applied and protection provided as called for in "Maintenance Procedure".



**The modification, rework, replacement, or substitution of any part of the Aerial Device with a means not equal to the original equipment provided by the manufacturer may cause serious personal injury.**

**GENERAL INFORMATION**

1. Keep inspection records up-to-date.
2. Record and report all discrepancies to your supervisor.
  - a. Records of frequent inspections do not need to be retained unless a discrepancy is found. In that case, a record of the discrepancy and the corrective action must be retained for five (5) years.
  - b. Periodic inspections must be dated, signed and kept for five (5) years.
3. A dirty Aerial Device and vehicle cannot be properly inspected. Keep your Aerial Device and vehicle clean!
4. Follow vehicle manufacturer's requirements for inspection, maintenance, and repairs.
5. Only qualified personnel shall do repairs and inspections.
6. Oil spills may require notifying Local, State, or Federal Authorities.
7. A post event inspection or test is required if the unit has been overloaded, shock loaded, overturned, in an accident, experienced electrical contact or applications of unintended external force.



**The following checklists must be used daily, 30 days (120 hours), 90 days (360 hours), 180 days (720 hours), 12 months (1,050 hours) and 5 years. Failure to do so could endanger the life of the operator. Always remember, scheduled maintenance can save much more than it costs.**

**NOTE: The following check points listed are the minimum recommended by Terex South Dakota, Inc. They are subject to supplementation to conform with your own company regulations.**

**NOTE: Remember that the safety of all personnel and the operational efficiency of the Aerial Device are dependent upon thorough inspections and maintenance practices.**

**NOTE: Dirty or dusty conditions or unusual weather conditions may require more frequent maintenance.**



**Changes to the vehicle computer settings could affect equipment operation and could result in crushing or tip over that could cause death or serious injury.**

- Do not alter computer settings without full knowledge of affect of changes.
- See information supplied with truck manuals and contact final stage manufacturer for required settings.





## **FREQUENT AND PERIODIC INSPECTION INTERVALS**

### **DAILY**

1. Check all controls and interlock for proper operation.
2. Inspect fall arrest equipment and attachments.
3. Inspect visual and audible devices.
4. Check cleanliness and dryness of fiberglass components.
5. Visually check for missing, damaged, or loose covers and guards.
6. Check for missing and illegible warning, operational, or instructional markings.
7. Visually check oil level in hydraulic reservoir.
8. Visually inspect for leaks in hydraulic system and hose condition.
9. Visually check all cylinders for leaks.
10. Visually inspect leveling system. (Chains and Insulator Assemblies)
11. Visually inspect all pins, retainers, and fasteners for tightness.
12. Visual inspection of all structural members for cracks and permanent deformation.
13. Check for rotational obstructions.
14. Visual inspection of all visible electrical wires.
15. Operational test of all boom functions and drift.
16. Inspect load line, hook, and slings.
17. Tires for damage and proper inflation.
18. Parking brake for proper operation.
19. Vehicle inspection and load securement.
20. Verify operation of limit system.

### **30 DAYS (120 HOURS)**

1. Exchange leveling system battery with charged battery in cab of truck. (Units without generator)

### **90 DAYS (360 HOURS)**

1. Replace return filter.
2. Visually inspect all pins and retainers.
3. Lubricate all points per lubrication chart recommendations.
4. Apply lubricant to rotation gear box, rotation bearing, pivot points, and leveling gearbox.
5. Repair or replace items found to be worn or damaged.
6. Replace Fiber Optic switch batteries at boom tip (AA lithium).
7. Verify interlock and enable operation.
8. Daily and 30 days (120 hours) inspections.

**180 DAYS (720 HOURS)**

1. Inspect exposed hoses.
2. Clean hydraulic tank breather.
3. Check tightness of rotation bearing bolts, turntable to bearing, and bearing to pedestal for proper torque.
4. Check lubricant of winch speed reducer and rotation speed reducer.
5. Daily, 30 days (120 hours), and 90 days (360 hours) inspections.

**12 MONTHS (1,050 HOURS)**

1. Inspect and lubricate PTO drive shaft to pump.
2. Take samples of hydraulic oil and test.
3. Check all system pressure adjustments for proper setting.
4. Replace hi-pressure filters.
5. Perform cylinder drift tests.
6. Clean pilot control inlet filters.
7. Perform structural and critical weld inspections.
8. Perform dielectric tests.
9. Visually inspect any vacuum prevention system and verify proper operation.
10. Perform leveling system inspections.
11. Daily, 30 days (120 hours), 90 days (360 hours), and 180 days (720 hours) inspections.

**5 YEARS**

1. Remove, disassemble and inspect leveling gearbox.

**MAJOR STRUCTURAL INSPECTION**

A major structural inspection is required after the aerial device has been in service for 10 years (10,500 hours) and every 10 years (10,500 hours) thereafter. The major structural inspection requires the following:

1. Perform a load test. With the mobile unit set up for aerial device operation on level ground, perform a load test of one and one-half times the rated capacity of the aerial device with the aerial device booms in the maximum overturning moment position. If the machine can position the upper boom overcenter, the load test must also be done with the upper boom in the overcenter position with the test load based on that boom position. If the machine is configured for material handling, simultaneously apply the material handling test load from the material handling device and apply the platform capacity test load from the center of the platform.
2. Perform structural and critical weld inspections per the requirements of Section 102 of this manual.
3. Repair or replace components as needed.



## OPERATIONAL TESTS

Perform all of the tests and checks that follow. Cycle times must be within limits. Repair the problem that is evident in the component.

### SPEED TESTS

Speed tests should be taken with one man in platform and hydraulic fluid at normal operating temperature. Check that all times are within the limits specified in the Quick Reference Guide.

1. Check that boom(s) operate smoothly over full travel, without squeaking or other noise.
2. Check that all moveable hydraulic and control hoses operate over full range of boom and turntable movements without stretching, kinking or rubbing on sharp corners.

### CONTROL SYSTEM

1. Check that all moveable hydraulic and control hoses operate over full range of boom and turntable movements without stretching, kinking or rubbing on sharp corners.
2. Check that control handle returns to neutral when released from any position.
3. Check that all movements can be made to start smoothly, without jerking or sudden motion when control handle is moved slowly.
4. Check that control head trigger energizes and de-energizes system so no movement of the booms occurs if not actuated.

### ELECTRICAL TESTS

Dielectric integrity of the booms must be tested every year or 1,050 hours of operation, whichever occurs first, or if insulating components are replaced or if the insulation value is in question.



**Platform insulation must never be depended upon when operating in an electrical environment, and platform must be considered as having no insulation value without a tested and certified liner installed.**

Follow electrical test specifications as prescribed by ANSI A92.2 for proper test procedure for the classification of unit being tested. See Maintenance Manual for proper dielectric testing.

### POST EVENT INSPECTION AND TEST

After any event where the aerial is subject to excessive loading or stress such as; overturning, unintended external mechanical or electrical forces, shock loading or overload, the aerial device shall be removed from service and a periodic inspection performed. In addition to the periodic inspection other non-destructive inspection procedures may be required to detect possible structural damage. All damaged items shall be replace or repaired before the unit is returned to service. Return to service shall be approved by a qualified person and the inspection and repair information recorded and retained.

**LUBRICATION CHART**

**TEREX TELELECT LINESMAN TM SERIES**

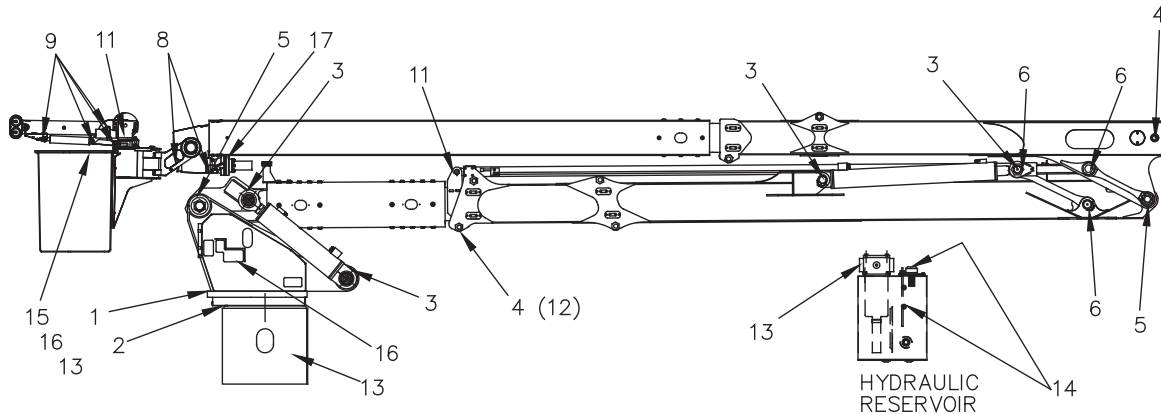

TRADEMARKS: IsoControl

ITEM	LUBRICATION POINT		LUBRICANT RECOMMENDED	SERVICE	
				INTERVAL	METHOD
1	ROTATION BEARING	**	LITHIUM-BASE EP #2 GREASE	90 DAYS OR 360 HRS	GREASE GUN BRUSH
2	ROTATION GEAR TEETH				
3	CYL. BALL BUSHINGS				
4	BUSHINGS				
5	BOOM PIVOT BUSHINGS				
6	ELBOW LINK BUSHINGS				
7	JIB CYLINDER PIVOTS				
8	BASKET LEVELING GEARBOX	***			
9	JIB PIVOT AND LINKAGE		LUBRICATING OIL	AS REQ'D.	SPRAY
10	WINCH DRUM BEARINGS				
11	WINCH SPEED REDUCER		GL-5 EP, 85W140 GEARLUBE	180 DAYS	† FILL IF LOW
12	ROTATION SPEED REDUCER		MOBILUX <sup>®</sup> EP 023	180 DAYS	† FILL IF LOW
13	FILTERS		SEE MAINTENANCE MANUAL		
14	HYDRAULIC RESERVOIR	*	PREMIUM ISO 15 HYDRAULIC FLUID	DAILY	† FILL IF LOW
15	CONTROL HANDLE PIVOTS		LUBRICATING OIL	AS REQ'D.	SPRAY
16	VALVE LINKAGE				
17	LEVEL GEAR REDUCER	*	GL-5 EP, 85W140 GEARLUBE		† FILL IF LOW

USE THE ABOVE PRODUCTS OR EQUIVALENT:

† ALWAYS DRAIN AND REFILL WHEN DISASSEMBLED OR REBUILT.

NOTE: ALL MOVING PARTS NOT EQUIPPED WITH GREASE FITTINGS SHOULD BE LUBRICATED WITH A PENETRATING TYPE LUBRICANT AS REQUIRED.

ALWAYS LUBRICATE IF DISASSEMBLED.

DUSTY AND DIRTY CONDITIONS WILL REQUIRE MORE FREQUENT LUBRICATION.

\* DRAIN & FILL WHEN CONTAMINATED. SEE MANUAL FOR PROPER OIL FOR COLD WEATHER APPLICATIONS.

\*\* LUBRICATE SPARINGLY EVERY 1/8 REVOLUTION, FOR TWO REVOLUTIONS.

\*\*\* LUBRICATE ONE PUMP EACH ZERK (2).

472799B



## WINCH ROPE INSPECTION

All stable braid ropes in continuous service should be visually inspected once every working day. A thorough inspection of all ropes in use should be made at least once a month and a full written, dated and signed report of rope condition kept on file where readily available. All inspection should be performed by an authorized person.

All stable braid ropes installed on a machine which has been idle for a period of one week or more due to shut down or storage should be given a thorough inspection before being placed in service. This inspection should be performed by an authorized person whose approval should be required for further use of the rope. A written and dated report of the rope condition should be filed.

Continued use and normal wear on rope gradually diminishes the ultimate breaking strength and lowers the factor of safety. In determining the proper discard time of stable braid rope, the following guides are suggested:

1. If as many as one half of the cover strands are cut at a given point, this damaged section should be cut out and the rope rejoined with a standard end-for-end splice. If within 10 ft. (3 m) of the eye, put in a new eye splice. It can then be used normally. If a few damaged strands spaced out along the rope at intervals is evident, the rope should be periodically examined.



**Eye splices at the end of the winch line should be done in strict accordance with the steps and procedures outlined by the rope manufacturer.**

2. If the individual cover strands have been worn down after extended use to within 50 percent of their original bulk over an extended area of the line, then the line should be discarded (or assigned to a less critical task). This can best be determined by examination and comparison of the bulk of an individual strand which is exposed and subject to wear with that same strand where it crosses under other strands and is protected (and therefore is full size).

It should be kept in mind that the rope can be cut and damaged by sharp edges. Therefore, it should not be exposed to sharp edges and surfaces such as metal burrs on winch drums, sheaves, etc. When installing rope on older machines, great care must be exercised to assure that the rope does not come in contact with hardware that has been scored and chewed by previously used wire rope lines.

Winch rope has its best dielectric properties when it is new and clean. Dirt, grease, other foreign matter and moisture -humidity- will alter these dielectric properties, thus the rope should be kept clean and dry. The rope can be cleaned by washing in a mild detergent and warm water, rinsed and air dried. Water can be trapped between the fibers and should be squeezed out by placing the line under tension and air-dried.



**The insulating factors of a fiberglass boom or jib can be affected by dirty, wet or contaminated rope.**

The first layer of wraps around the winch drum should be applied closely and tightly with some tension. This will prevent subsequent wraps from slipping down between the turns when tension is applied.

Certain chemicals will break down the fibers of the rope. Chemicals to avoid are sulfuric acids, alkalis, or chlorinated hydrocarbons over 160 degrees F (71 degrees C). Strong cleaning agents or bleaches may also be harmful.



**When replacing rope, make sure the correct rope type is installed. All ropes are not constructed the same and have different ratings.**

## DAILY ROPE INSPECTION

The synthetic rope must be inspected daily for any deterioration, resulting in appreciable loss of strength, such as described below.

1. Excessive external roughness.
2. Glossy or glazed areas, which indicates heat damage.
3. Look for flat areas, bumps, or lumps, which indicates core or internal damage.
4. Cut or badly frayed strands.
5. Areas of discoloration, which could be caused by chemical contamination.
6. Stiffness, which would indicate excessive dirt or grit embedded or shock load damage.
7. Open the strands and look for powdered fibers, which means there is internal wear.
8. Inspect eye connection for proper weaving and damage.

If any of the above conditions are found it should be reported to a qualified person to determine if the synthetic rope should remain in service. Further information can be found in the maintenance manual for determining the replacement of the synthetic rope.

If there is any doubt or question about the condition of the synthetic rope -replace it!

## HOOK INSPECTION

The load line hook and safety latch must be inspected daily. Any hooks showing defects shall be discarded. Field repairs by welding or re-shaping shall not be permitted.

- Any damaged hook safety latch shall be replaced immediately.
- Any hook or fitting with a crack or distortion shall be removed from service immediately.
- Hook nut (if equipped) should be checked for corrosion or deformation.
- Refer to hook manufacturer for more specific inspection instructions.



**Hook latches are to be used only as retention devices to retain loose rigging under slack conditions. They are not intended to be anti-fouling devices and caution must be exercised to prevent a latch from supporting any portion of a load. Periodic inspection of the latch must be made to insure it's proper operating condition. If damage to the latch occurs, the latch must be replaced immediately.**

## STORAGE PROCEDURE

When a unit will not be used for a period of time, it should be prepared for storage to reduce the deteriorating effects of the environment. This includes the following:

- Wash and clean to remove accumulated road grime. It can discolor the paint if left on for long periods of time.
- Clean and wax the fiberglass components. If storage is in the sun, cover the booms.
- Clean and coat the exposed cylinder rods with grease, preservative spray or heavy preservative oil.
- Clean and grease the exposed valve spools and linkage.
- Lubricate the entire Aerial Device following the lube chart.
- Check the oil for pH level and water content. Acidic oil or water in the oil may settle out during storage and can rust the interior of the hydraulic system.
- Cover the platform to prevent water from accumulating. A platform full of water can weigh over 900 lbs. (408 kg) and exceed the capacity of the platform.
- Ensure the hydraulic tank filler-breather filter is intact to prevent dirt entering the tank when the temperature changes.
- Grease all sliding surfaces where there is metal contact to prevent rust.
- Touch up any bare metal and where the paint is chipped or cracked.
- Spray the electric collector commutators with LPS 1 or CRC 5-56 to prevent corrosion of the surface.
- Service the truck as recommended by the manufacturer.

**NOTE: The period of time between uses when the unit should be prepared for storage varies with the location. If the climate is temperate and dry it may be 4 months. If it is in a humid area next to the ocean with the salt air it may be only 2 weeks.**

**MAINTENANCE GUIDELINES**





# APPENDIX - A

## STANDARDS AND REGULATIONS

In addition to the operational instructions provided herein, various standards and governmental regulations must be followed in the use and operation of your Terex South Dakota, Inc. unit.

### ANSI STANDARDS

ANSI standards that are applicable to the operation and maintenance of your unit:

1. ANSI A92.2 (latest revision) Vehicle Mounted Elevating and Rotating Aerial Devices,
2. ANSI A10.31 (latest revision) Digger Derricks - Safety Requirements, Definitions and Specifications (A partial extraction is included in this appendix),
3. ANSI C2, Part 4 (latest revision) (National Electric Safety Code®) Rules for the Operation of Electric Supply and Communication Lines and Equipment,
4. ANSI Z133.1 (latest revision) Safety Requirements for Tree Pruning, Trimming, Repairing, or Removal.

For complete, current copies of ANSI standards, you must annually write to the following:

American National Standards Institute  
11 West 42nd Street  
New York, NY 10036

Copies of the standards can also be found on the Internet at:

[www.ansi.org](http://www.ansi.org)

### OSHA REGULATIONS

OSHA regulations that are applicable to the operation and maintenance of your unit:

1. OSHA Subpart V, Power Transmission and Distribution,
2. OSHA 1910.67, Vehicle Mounted Elevating and Rotating Cable Placers,
3. OSHA 1910.268, Telecommunications,
4. OSHA 1910.269, Electrical Power Generation, Transmission and Distribution,
5. OSHA Subpart M, Fall ,
6. OSHA 1910.147, The Control Of Hazardous Energy (Lockout/Tagout),
7. OSHA Subpart S, Electrical,
8. OSHA 1910.333, Selection and use of work practices.
9. OSHA Subpart CC, - Cranes and Derricks in Construction

For complete, current copies of OSHA regulations, you must annually write to the following or contact your OSHA Regional Office.

Technical Data Center  
Frances Perkins Department Of Labor Building  
Room N2439  
200 Constitution Avenue  
Washington, DC 20210

Copies of the standards can also be found on the Internet at:

[www.osha.gov](http://www.osha.gov)

These are not all inclusive of the applicable codes, standards, or regulations. It is your responsibility and your employer's responsibility to identify and comply with applicable codes, standards and regulations.

The information provided herein is accurate as of the date your Terex South Dakota, Inc. unit was manufactured. You must comply with the codes, standards and regulations as they are updated over time. It is your employer's responsibility to obtain copies and comply with all standards and regulations.



## OSHA EXCERPTS: (CLEARANCE DISTANCE)

The following are excerpts from OSHA Standards. They are not complete and do not cover all safety work rules. Refer to the most current version of OSHA regulations available at [www.osha.gov](http://www.osha.gov) for any changes since this manual was printed.

### Partial excerpt from Subpart S - Electrical: (02-01-1998 Edition)

1910.333 Selection and use of work practices.

(c), (i) Unqualified person.

(A) When an unqualified person is working in an elevated position near overhead lines, the location shall be such that the person and the longest conductive object he or she may contact cannot come closer to any unguarded, energized overhead line than the following distances:

1. For voltages to ground 50kV or below - 10 feet (3.05 m);
2. For voltages to ground over 50kV - 10 feet (3.05 m) plus four inches (101.6 mm) for every 10kV over 50kV.

(B) When an unqualified person is working on the ground in the vicinity of overhead lines, the person may not bring any conductive object closer to unguarded, energized overhead lines than the distances given in paragraph (c)(3)(i)(A) of this section.

**NOTE: For voltages normally encountered with overhead power line, objects which do not have an insulating rating for the voltage involved are considered to be conductive.**

### Excerpt from OSHA subpart V - Power Transmission and Distribution (11-14-1990 Edition)

1926.950 General Requirements (c) Clearances. The provisions of paragraph (1) or (2) of this section shall be observed.

(1) No employee shall be permitted to approach or take any conductive object without an approved insulating handle closer to exposed energized parts than shown in Table R-6, unless:

(i) The employee is insulated or guarded from the energized part (gloves or gloves with sleeves rated for the voltage involved shall be considered insulation of the employee from the energized part), or

(ii) The energized part is insulated or guarded from him and any other conductive object at different potential, or

(iii) The employee is isolated, insulated, or guarded from any other conductive object(s), as during live-line bare-hand work.

(2)(i) The minimum working distance and minimum clear hot stick distances stated in Table R-6 shall not be violated. The minimum clear hot stick distance is that for the use of line-line tools held by lineman when performing live-line work. (e)(15) The minimum clearance distances for live-line bare-hand work shall be as specified in Table R-7. These minimum clearance distances shall be maintained from all grounded objects and from lines and equipment at a different potential than that to which the insulated Cable Placer is bonded unless such grounded objects or other lines and equipment are covered by insulated guards. These distances shall be maintained when approaching, leaving and when bonded to the energized circuit.

#### 1926.960(c)(1)(i)

The employer shall establish minimum approach distances no less than the distances computed by Table V-2 for ac systems or Table V-7 for dc systems.

#### 1926.960(g)(2)

Estimate of available heat energy. For each employee exposed to hazards from electric arcs, the employer shall make a reasonable estimate of the incident heat energy to which the employee would be exposed.

#### 1926.960(g)(3)

Prohibited clothing. The employer shall ensure that each employee who is exposed to hazards from flames or electric arcs does not wear clothing that could melt onto his or her skin or that could ignite and continue to burn when exposed to flames or the heat energy estimated under paragraph (g)(2) of this section.



**Clearance to energized components and lines**

These minimum approach distance charts are provided for reference only. Follow your companies, OSHA's or NESC for specific clearance distances required.

NOMINAL VOLTAGE (KV) (PHASE TO PHASE)	DISTANCE			
	PHASE-TO-GROUND EXPOSURE		PHASE-TO-PHASE EXPOSURE	
	M	FT	M	FT
0.050 TO 0.300 <sup>2</sup>	AVOID CONTACT		AVOID CONTACT	
0.301 TO 0.750 <sup>2</sup>	0.33	1.09	0.33	1.09
0.751 TO 5.0	0.63	2.07	0.63	2.07
5.1 TO 15.0	0.65	2.14	0.68	2.24
15.1 TO 36.0	0.77	2.53	0.89	2.92
36.1 TO 46.0	0.84	2.76	0.98	3.22
46.1 TO 72.5	1.00	3.29	1.20	3.94

1. Employers may use the minimum approach distances in this table provided the worksite is at an elevation of 900 meters (3,000 feet) or less. If employees will be working at elevations greater than 900 meters (3,000 feet) above mean sea level, the employer shall determine minimum approach distances by multiplying the distances in this table by the correction factor in Table R-5 corresponding to the altitude of the work.

2. For single-phase systems, use voltage-to-ground.

TABLE R-6 - ALTERNATIVE MINIMUM APPROACH DISTANCES FOR VOLTAGES OF 72.5 KV AND LESS

VOLTAGE RANGE PHASE TO PHASE (KV)	PHASE-TO-GROUND EXPOSURE		PHASE-TO-PHASE EXPOSURE	
	M	FT	M	FT
72.6 TO 121.0	1.13	3.71	1.42	4.66
121.1 TO 145.0	1.30	4.27	1.64	5.38
145.1 TO 169.0	1.46	4.79	1.94	6.36
169.1 TO 242.0	2.01	6.59	3.08	10.10
242.1 TO 362.0	3.41	11.19	5.52	18.11
362.1 TO 420.0	4.25	13.94	6.81	22.34
420.1 TO 550.0	5.07	16.63	8.24	27.03
550.1 TO 800.0	6.88	22.57	11.38	37.34

1. Employers may use the minimum approach distances in this table provided the worksite is at an elevation of 900 meters (3,000 ft) or less. If employees will be working at elevations greater than 900 meters (3,000 feet) above mean sea level, the employer shall determine minimum approach distances by multiplying the distances in this table by the correction factor in Table R-5 corresponding to the altitude of the work.









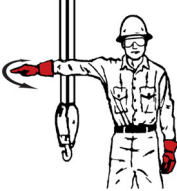
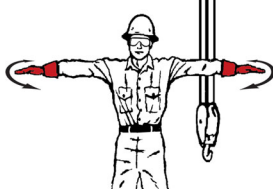

2. Employers may use the phase-to-phase minimum approach distances in this table provided that no insulated tool spans the gap and no large conductive object is in the gap.

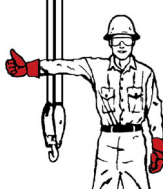
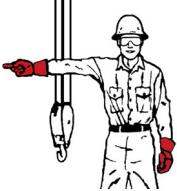
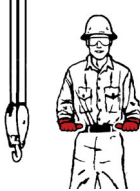
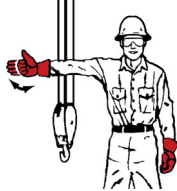
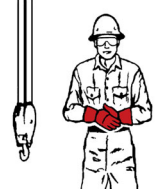
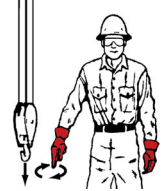
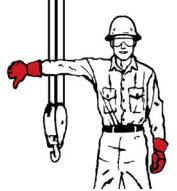
3. The clear live-line tool distance shall equal or exceed the values for the indicated voltage ranges.

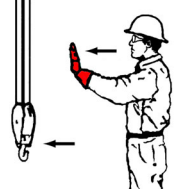
TABLE R-7 ALTERNATIVE MINIMUM APPROACH DISTANCES FOR VOLTAGES OF MORE THAN 72.5 KV

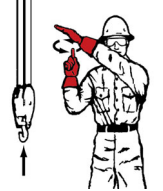
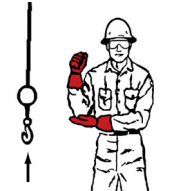

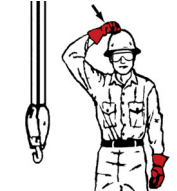
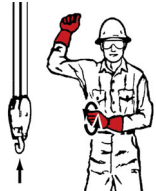
STANDARD HAND SIGNALS

 <p><b>STOP.</b> With arm extended horizontally to the side, palm down, arm is swung back and forth.</p>	 <p><b>EMERGENCY STOP.</b> With both arms extended horizontally to the side, palms down, arms are swung back and forth.</p>	 <p><b>HOIST.</b> With upper arm extended to the side, forearm and index finger pointing straight up, hand and finger make small circles.</p>	 <p><b>RAISE BOOM.</b> With arm extended horizontally to the side, thumb points up with other fingers closed.</p>	
 <p><b>SWING.</b> With arm extended horizontally, index finger points in direction that boom is to swing.</p>	 <p><b>RETRACT TELESCOPING BOOM.</b> With hands to the front at waist level, thumbs point at each other with other fingers closed.</p>	 <p><b>RAISE THE BOOM AND LOWER THE LOAD.</b> With arm extended horizontally to the side and thumb pointing up, fingers open and close while load movement is desired.</p>	 <p><b>DOG EVERYTHING.</b> Hands held together at waist level.</p>	 <p><b>LOWER.</b> With arm and index finger pointing down, hand and finger make small circles.</p>
 <p><b>LOWER BOOM.</b> With arm extended horizontally to the side, thumb points down with other fingers closed.</p>	 <p><b>EXTEND TELESCOPING BOOM.</b> With hands to the front at waist level, thumbs point outward with other fingers closed.</p>	 <p><b>TRAVEL/TOWER TRAVEL.</b> With all fingers pointing up, arm is extended horizontally out and back to make a pushing motion in the direction of travel.</p>	 <p><b>LOWER THE BOOM AND RAISE THE LOAD.</b> With arm extended horizontally to the side and thumb pointing down, fingers open and close while load movement is desired.</p>	 <p><b>MOVE SLOWLY.</b> A hand is placed in front of the hand that is giving the action signal.</p>
 <p><b>USE AUXILIARY HOIST (WHIPLINE).</b> With arm bent at elbow and forearm vertical, elbow is tapped with other hand. Then regular signal is used to indicate desired action.</p>	 <p><b>CRAWLER CRANE TRAVEL, BOTH TRACKS.</b> Rotate fists around each other in front of body; direction of rotation away from body indicates travel forward; rotation toward body indicates travel backward.</p>	 <p><b>USE MAIN HOIST.</b> A hand taps on top of the head. Then regular signal is given to indicate desired action.</p>	 <p><b>CRAWLER CRANE TRAVEL, ONE TRACK.</b> Indicate track to be locked by raising fist on that side. Rotate other fist in front of body in direction that other track is to travel.</p>	 <p><b>TROLLEY TRAVEL.</b> With palm up, fingers closed and thumb pointing in direction of motion, hand is jerked horizontally in direction trolley is to travel.</p>

**NOTE: Not all signals can be used on Digger Derricks or Aerial Devices. Method of signaling must be agreed upon by ground person and operator before work begins.**

# APPENDIX - B

## RESPONSIBILITIES (ANSI A92.2-2021)

The ANSI/SAIA A92.2-2021 standard in the interest of safety has assigned responsibilities to each entity involved in the use of aerial devices once it leaves the manufacturer. This includes the, Dealer, Installers, Service Entities, Owner, User, Operators, Lessors, Lessees, and Brokers. The following is a basic overview of the responsibilities of each entity, it is not complete. To determine the full requirements, purchase the current ANSI/SAIA A92.2 standard or the ANSI/SAIA A92.2 Manual of Responsibilities.

<https://webstore.ansi.org/Standards/SIA/ANSISAIAA922021>

You can purchase the ANSI/SAIA A92.2 Manual of Responsibilities from Terex Utilities P/N 494633.

The AEM Safety Manual provides important safety information, (Terex Utilities P/N 494635). It can be ordered from AEM at : <https://shop.aem.org/en/AEM%20Safety/aem-safety-products/aerial-devices-safety-manual/> AEM also has other languages available.

All people and entities involved in the use of aerial devices must remember that the aerial device is used to lift personnel to heights to perform work which may become hazardous if the aerial is not properly installed, inspected, maintained, and operated by trained and qualified people. Operators must be trained and qualified not only to operate the aerial device, but also to safely perform the tasks assigned by their employer.

The inspection, testing, maintenance, and repair of the chassis shall follow the chassis manufacturer's, DOT, and FMVSS requirements.

The responsibilities stated in the current standard apply to all Aerial Devices, regardless of the date of manufacture for: Dealer, Installers, Service Entities, Owner, User, Operators, Lessors, Lessees, and Brokers.



**All entities involved in the manufacture, selling, installation, servicing, owning, using, operating, lessor, lessee, and brokers must comply with their responsibilities for safe use of aerials. Failure to uphold your responsibilities may cause death or serious injury.**

The following is a paraphrased overview of the responsibilities of each entity; due to copy right issues. Refer to the ANSI/SAIA A92.2 -2015 Standard or Manual of Responsibilities for complete information, definitions, and test procedures.

Each entity involved with Aerial Devices must comply with their respective responsibilities.

### Dealer, Installer, and Service Entities Responsibilities (Section 7)

- The installer, new or remount, is to work with the owner to verify the vehicle selected is within the vehicle weight ratings and has sufficient strength following at least the Aerial Device manufacturer's minimum vehicle specifications.
- The payload of the vehicle will satisfy the owner and remain within the weight and weight distribution of the vehicle manufacturer and comply with all DOT and FMVSS requirements.
- The installer is to have certification as a manufacturer for motor vehicles used on highways.
- The dealer, installer, or service entities must have a documented quality assurance program.
- The installer must provide all manuals they receive to the owner, for items installed or shipped with the finished vehicle.
- Provide the manufacturer with the aerial device model and serial number and the name, and contact information for the owner.
- The owner or user must be informed of their responsibilities.
- The installer must follow the instructions of the manufacturer for installation.
- The lower controls must not be accessible while standing on the ground but must be accessible for testing and overriding upper controls.



- The installer must complete stability tests, dielectric tests, operational tests, and visual inspections before delivery.
- Install a label the driver can see stating the overall travel height.
- Training and training material for inspection, service, and operation shall be offered to the owner or user if requested.
- The Ingress and Egress provided must follow the requirements stated in the standard.
- All welding performed on structural components must follow the requirements of AWS D1.1 or AWS D1.2 with appropriate documentation for the weld procedures and welder qualification.
- Only qualified and trained personnel shall perform inspections, testing, and maintenance following the manufacturers recommendations.
- A method to prevent the Vehicles from being operated by people not approved by the owner must be provided.
- The dates of mandatory structural component replacement items must be placed on the aerial and record maintained.
- A placard stating the date of inspection and tests performed must be placed on the Aerial Device with such records retained for 5 years.
- If the dealer, installer, or service entity have people operate the units they assume the respective responsibilities as users and operators.

### Owner Responsibilities (Section 8)

- The owner is responsible for all inspections, testing, and maintenance of the aerial device.
  - Including initial inspection and test prior to first use of new or modified units.
  - Regular inspection, test, and maintenance. This includes any issues detected during use and daily inspections due to function, wear, deterioration, or damage.
    - Frequent Inspection and Test are Daily to Monthly.
    - Periodic Inspection and test are Monthly to twelve Months.
- Inspections and test must be performed as recommended by the aerial manufacturer in the Operator's Manual and Maintenance Manual and all bulletins. This includes:
  - Frequent and Operators daily pre-shift visual inspection and operation tests include but not limited to:
    - Structural inspection for any damage, cracks, excessive wear, or deformation
      - (a) Loose, deformed, or missing bolts, pins, or keepers.
      - (b) Missing covers or guards.
    - Missing or illegible control labels, warning decals or placards
    - Boom insulating component cleanliness, condition, or deterioration
    - Hydraulic leaks and oil level
    - Check inspection labels to determine if dielectric tests and periodic Inspection are due.
    - Control operation
    - Interlock operation
    - Electrical components operate properly
    - Functional tests to include but not limited to:
      - Park and setup unit including stabilizers to be able to operate
      - Cycle unit from lower controls through full range of motion being aware of any hazards
      - Verify all STOP functions operate
  - If anything found at any inspection, by observation, or during operation that is suspected to not comply or may create a safety hazard a qualified person must determine if it is safe to use.





- Periodic inspections and test include the same items as the daily pre-shift inspection, but are more involved. Follow the manufacturer’s instructions and manuals to include but not limited to:
    - Inspect condition of fiberglass for damage, cleanliness, and insulating material condition inside and outside of all components in the insulating span.
    - Insulating aerials require an annual Periodic Dielectric Test of the booms, liners, and high resistance handles, if equipped.
    - Category A Aerials used for bare hand work at least every 6 months require a dielectric test every 3 years.
    - Structural inspection for deformation, cracks, corrosion, or wear.
    - Inspect all welds.
    - Components such as pins, bearings, shafts, gears, rollers, all locking devices, chains, sprockets, leveling rods, ropes and sheaves for deformation, damage, cracks, or wear.
    - Inspect all fasteners condition and tightness, including upper and lower turntable bearing bolt torque check.
    - Hydraulic hoses, fittings, and components for leakage deformation or wear.
    - Motors and pumps for leaks and vibration noise, running hot, or not performing properly.
    - Hydraulic cylinders and holding valves for malfunction and damage.
    - Change the hydraulic filters, check the oil for contamination if required.
    - If the insulating booms are replaced a dielectric qualification test is required.
    - Test all boom functions.
    - All labels and warning decals are legible.
  - If anything found at any inspection, by observation, or during operation that is suspected to not comply or may create a safety hazard; a qualified person must determine if it is safe to use.
  - **All unsafe items or condition must be repaired or replaced before further use.**
  - At 15 years a major Structural inspection, load test, and stability test, based on the manufacturer’s recommendations, must be performed. Repeat subsequently every 10-years. All damaged and worn items must be repaired or replaced.
  - Post Event Inspection and Test. If the unit is subject to a load more than the rated capacity, shock load, external load, overturning, or electrical contact the machine must be inspected before further use by a qualified person.
  - Record retention: Daily inspections do not need to be retained unless a safety issue is found. All other inspection, test and repairs records must be retained for 5 years.
  - All welding performed on structural components must follow the requirements of AWS D1.1 or AWS D1.2 with appropriate documentation for the weld procedures and the welder qualification.
  - All modification must be approved in writing by the manufacturer or if the manufacture is not available by a equivalent entity only after an engineer analysis determines the safety factors will be maintained or greater.
- Any modifications to the boom tip or insulating areas will require the Aerial Device to have a dielectric qualification test performed, because the previous test is no longer valid.
- Alterations are not allowed. Do not remove or disabling any safety device, removing covers, disabling or overriding interlocks or safety devices.
  - Follow the manufacturers recommendations for testing and repairs.
  - The owner must ensure the weight distribution of the completed unit, height, and loading remains within DOT and FMVSS limits and do not affect stability.
  - When an aerial device is sold; the Operator’s Manual must accompany the unit to the new owner. The new owner is required to notify the manufacture the aerial information and their name and address within 60 days. If sold through a broker, the owner is still responsible.



- All decals, labels and plaques must be legible or replaced if not.
- Safety bulletins issued by the manufacturer, dealer or installer must be completed as instructed.
- Manuals are on the vehicle available to the Operator.
- Changes to the axle or vehicle loading cannot exceed the vehicle rating.
- All replacement parts must be identical to the original for specification and function.

### Training

- All Personnel must be trained by a qualified person to operate the Aerial Device and to perform the tasks their employer assigns. This include recognizing and avoiding hazardous situations.
- The use and importance of the Operator's manuals.
- Where the manuals are stored on the vehicle, so they are available to the operator or ground personnel.
- Prestart Inspection training.
- What to do if the unit is not operating properly, who to inform if needed to resolve the issue with safety in mind.
- Modifications and alternations are not allowed. All covers, interlocks, and safety devices must be maintained and not overridden.
- Understand the operation limits and maximum slope the unit can be used on.
- Operation with the platform occupied must be from the platform controls. The lower controls are for test, inspection, maintenance, and rescue only.
- Follow all safety rules from ANSI, OSHA, Industry work methods and Employers safety manual. Examples include ANSI C2 Part 4 National Electrical Safety Code, the reference standards in this ANSI A92.2 standard, and others for the work being performed.
- Trained to perform a workplace inspection for hazards affecting safe operation of the Aerial Device and the task to be performed.
- Operators must have authorization to operate and trained to prevent unauthorized use.
- Follow all Warnings and Instructions on the unit and I manuals provided with the Aerial.
- Use OSHA compliant fall arrest system attached to the anchor provided for all platform occupants.
- Operate the Aerial Device, while directed by a qualified person, long enough to demonstrate proficiency of all control functions and safe use, through full range of motion.
- Proper stowing procedures for transport and precautions for moving following the manufacturers procedures and required load securement.

### Retraining

- The user determines if retraining is required, based on observations, evaluation of proficiency, and safe operation.
- Retraining is required for operators after a near miss or an accident.

### Familiarization

- Operators who are told to operate an aerial device they are not familiar with, have not operated before, must become familiar with its operation, functions, and features before using.
  - They must know the location of the manuals, and understand the warnings, and instructions provided by the manufacturer.
  - The purpose and function of the controls.





## APPENDIX B

- Operating characteristics of the specific unit. The function of safety devices and operator aids.
- Operate the aerial device long enough to become proficient in its safe operation.
- Users can self-familiarize if authorized by the owner and the above items are completed.

### Owner as Lessor

- The responsibilities of Lessor, section 11, in addition will apply to the owner if they lease an aerial.

### User Responsibilities (Section 9)

#### Training required

- Only authorized and trained personnel can be allowed to operate an aerial device.
- When an operator is directed to operate an aerial; general training shall be provided by a qualified person for inspection, application, operation, recognition and avoidance of hazards, and danger from operation of aerials and the task assigned.
- Training shall cover:
  - Instructed on the location of the manuals, the purpose, and use of manuals.
  - Understand the warnings and instructions both on the unit and in the manuals.
  - How to perform the Daily pre-shift inspection.
  - How to respond to operation problems or malfunctions.
  - Overriding interlocks is not allowed, operating without covers, or disable safety devices.
  - Perform a worksite inspection prior to setting up and operating for hazards.
  - Do not exceed the manufacturers allowable slope for operation. Understand the effect of slope and terrain on stability.
  - Always wear an OSHA compliant fall arrest system attached to the anchor provided.
  - Follow all safety rules from ANSI, OSHA, Industry work methods and Employers safety manual.
  - Utility workers follow the safety rules of ANSI/IEEE C2, other industries will have their own safety rules and regulations.
  - The operator must be authorized to operate the Aerial Device and know how to secure the vehicle to prevent unauthorized use.
  - Operate the aerial while directed by a qualified person long enough to become proficient and show safe operation at height and maximum side reach.
  - Follow the manufacturer's instructions to stow the aerial for transport. Follow the vehicle manufacturer's instructions for safe transport.

#### Retraining

- Retraining is required based on observations, evaluation of proficiency, and safe operation.
- Retraining is required if an accident occurs or has a near miss while operating an aerial device.

#### Familiarization

- Operators who are told to operate an aerial device they are not familiar with must become familiar with its operation, functions, and features before using.
  - They must know the location of the manuals, the warnings and instructions.
  - The purpose and function of the controls.
  - Safety devices and operating characteristics of the specific unit.
  - Operate the aerial device long enough to achieve proficiency.



- Users can self-familiarize if above items are completed.
- Proof of training should be provided if requested and maintained in the employee's file.
- The user shall only use the aerial device for the intended application as defined by the manufacture following all safe work requirements.
- The operator must be qualified and follow all safe work practices for personal protection when working around electrical hazards. They must use all PPE and maintain Minimum Approach Distance (MAD) from energized conductors.
- Use of an aerial device to lift energized lines requires an insulating tool separating the boom tip and platform from the line rated, tested, and maintained for the voltage.
- See Appendix F of the standard for more information and precautions. Follow all the safe work procedures in the employer's safety manual, ANSI standards, OSHA, and the APPA safety manuals.
- Use the aerial for bare hand work only if all procedures are followed and operators are qualified. The aerial must be a Category A unit tested and qualified for the voltage.
- The operator in the platform must control the aerial movements. Lower controls are for maintenance, rescue, or platform recovery only.
- Safety bulletins received from the manufacturer, dealer, installer, or owner must be completed as instructed.

## Operator Responsibilities (Section 10)

### Training Required

- Only trained and authorized personnel shall operate an Aerial device who have been familiarized with the specific Aerial they are operating.
- All decisions by the operator and operations of the machine must consider their safety and the safety of others.
- Do not use equipment if there are any safety issues, damage, or malfunctions. Report issues to responsible people for repair before further use.
- All personnel in the platform shall wear a fall arrest harness with lanyard attached to anchor provided on the aerial.
- Keep your feet on the floor of the platform, do not use other items to gain additional height or reach.
- Always set the parking brake before use of the aerial.
- Do not load the platform in a horizontal direction unless approved by the manufacturer.
- Do not load the platform with more than the capacity stated by the manufacturer. Do not add load at height which will exceed the capacity.
- Do not leave the platform when elevated to transfer to another device or structure unless following all OSHA regulations and IEEE 1307 standards. Do not exceed the platform or material handling capacity.
- If carrying materials larger than the platform they must be properly secured and distributed. Only tools and materials which can be handled by a person(s) working from the platform shall be moved. Such operations shall be performed in accordance with the manufacturer's instructions and limits. Follow the instructions and limits provided by the manufacturer.
- Altering or disabling safety devices, guards, or interlocks is prohibited, if so equipped.
- Overriding safety devices and interlocks is prohibited during normal operation or rescue, except when following the manufacturer's prescribed override procedures. Overriding during the testing, repair, or maintenance of an aerial device only when following the manufacturer's recommendations and procedures. Procedures for override shall be developed to minimize any unsafe condition which could exist.



- Observation of any defects shall be ongoing during operation.
- Pre-Start Inspection shall be performed by the operator daily prior to each shift. Following the manufacturer's recommendations for the aerial device. The following tests and inspections shall be performed by the operator prior to first use:
  - Perform a walk around visual inspection, looking for damaged components, cracks or corrosion, excessive wear, and any loose, deformed, or missing bolts, pins, fasteners, locking devices, and covers.
  - Check all controls and systems for proper operation; to include, but not limited to the following:
    - (a) Interlocks operate properly.
    - (b) Controls are not sticking and return to neutral when released.
    - (c) Controls operation properly and are clearly marked.
- Visual and audible devices operate properly per the manufacturer's requirements.
- Inspect fiberglass and insulating components for visible damage and contamination.
- Check and replace missing or illegible operational, warning, and instructional markings.
- Check for deterioration or leaking hydraulic and pneumatic systems.
- Check electrical systems of the aerial device for malfunction, deterioration, dirt, and moisture accumulation.
- Perform functional test, not limited, to the following. If any items are suspect; they must be examined by a qualified person to determine if they create a hazard. Replace or repair all unsafe items before use:
  - Set up the aerial device for operation, including stabilizers.
  - Operate each aerial function through its complete range of motion from the lower controls, except if operation through the full range would create a hazard.
  - Check emergency control function properly.
- Before transport, or moving, the aerial device must be in the manufacturer's recommended configuration including stabilizers.
- Worksite. Before the aerial device is used, the worksite shall be surveyed for hazards such as:
  - Supporting condition of the surfaces such as soft ground or tamped earth fills.
  - Ditches.
  - Drop-offs Too much slope, curbs, and interfering obstructions.
  - Debris.
  - Overhead obstructions and electrical conductors.
  - Weather conditions.
  - Unauthorized persons in work area.
  - Traffic on road or worksite.
  - Underground conditions such as chambers, underground utility components, or septic systems.
  - Environmental hazards or location hazards
- The Operator before and during each use shall:
  - Determine if there are overhead obstructions or electrical conductors or hazards.
  - Maintain distance from obstructions and minimum approach distance from electrical apparatus.
  - Follow and do not exceed the manufactures load capacity and distribution on the platform and/or lifting device.
  - Set outriggers and stabilizers following the manufacturer's instructions of equipped for proper stability.
  - Install guardrails properly and close gates if equipped.



- Use outrigger pads or cribbing when necessary to provide firm footing.
- When operating aerial device the operator detects any suspected malfunction of the aerial device, any hazard or potentially unsafe condition stop operation and request information from the user before further use or movement.
- During operation, if the boom or platform catches on an object preventing movement try to reverse the prior movement. If that fails, remove all platform personnel before trying to free.
- Do not move aerial devices with the platform occupied unless they are designed, properly equipped, and tested for mobile operation.
- Driving aerial devices:
  - Do not drive or travel on surfaces that do not provide adequate vehicle stability.
  - Maintain safe distance from other vehicles, objects and overhead lines or obstructions.
  - If designed, tested, and approved for mobile operation driver must maintain communications with the operator.
  - Conditions of the ground surface, congestion, and slope will determine the safe travel speed.
- Only Operators who have received instructions by a qualified person about inspection, application, and operation of aerial devices. This includes recognition and avoidance of hazards associated with safe operation. Include, but not limited to, the following.
  - The purpose and use of manuals.
  - That the Operating manuals are an integral part for safe operation, inspection, and maintenance of the aerial device and must be properly stored on the vehicle when not in use.
  - The importance of a pre-start inspection prior to each shift.
  - The Operator must know their responsibilities with problems or malfunctions affecting the operation of the aerial device.
  - Overriding safety devices is prohibited, except as approved by the manufacturer.
  - Lower controls shall not be used for purposes other than test or recovering the work platform.
  - Know what affects stability and the manufacturer's allowable slope and limits.
  - Understand the information on placards and decals.
  - Inspect the work site and workplace.
  - Know the safety rules and regulations, such as Part 4, ANSI/IEEE C2, National Electrical Safety Code (applies to utility workers as defined in ANSI/IEEE C2). Other safety rules will apply to use of aerial devices in other industries.
  - The Operator must be authorized to operate.
  - Securing the aerial device and mobile unit (MEWP) from unauthorized use.
  - The Operator must follow all warnings and instructions.
  - All platform occupants must properly use personal fall arrest protection equipment.
  - Operators must demonstrate proficiency by actual operation of the aerial device under the direction of a qualified person. They must operate for a sufficient period of time to show they are proficient in the operation of all control functions of the aerial device and safe use at operating height and reach.
  - Know how to properly stow the aerial device for transport and precautions for moving the mobile unit.

## Retraining

- The operator shall be retrained when so directed by the user, based on the following:
  - Evaluation and observation of the operator by the user. The evaluation of the operator shall include evaluating safe and proficient operation of the aerial device.
  - If the operator has a near miss or an accident while operating an aerial device.



## APPENDIX B

### Familiarization

- When directed to operate an aerial device they are not familiar with, a qualified person shall instruct them on the following, prior to operation:
  - The purpose and use of manuals.
  - Warnings and instructions provided by the manufacturer.
  - The purpose and function of all controls.

The operator shall operate the aerial device long enough become proficient in actual operation of the aerial device.

A qualified person (operator) may self-familiarize if the items above are completed when the user permits.

### Electrical Hazards

All work practices and safety procedures intended to protect personnel from electrical hazards shall be defined and explained to the operator by a qualified person. The operator shall maintain the appropriate Minimum Approach Distance (MAD) from energized conductors and apparatus, based on the operator's qualifications.

Use insulating devices that have been rated, tested, and maintained for the line voltage when lifting energized lines or components with an aerial device to prevent energizing the boom tip. See Appendix F of the actual A92.2 standard or if not available Appendix A of this manual for information on the Minimum Approach Distance, handling energized apparatus and other precautions.

### Responsibilities of Lessors or Lessees (Section 11)

Lessors or Lessees who use the aerial device as owner have the responsibility as shown for owners.

Lessors or Lessees who use the aerial device as users have the responsibility as shown for users.

Lessors or Lessees who use the aerial device as Operators have the responsibility as shown for Operators.

The lessor must fulfill the responsibilities of ownership which are not assigned to the lessee as the user.

The lessor of an aerial device must provide the Operator's Manual stored on the vehicle.

A frequent inspection and test shall be performed by the Lessor prior to delivery.

### Training

The Lessor shall offer training or training material on operation and maintenance at delivery or as requested.

Operators must receive instructions by a qualified person about inspection, application, and operation of the aerial devices. This includes recognition and avoidance of hazards associated with safe operation. Including, but not limited to, the following.

- The purpose and use of manuals.
- That the Operating manuals are an integral part for safe operation, inspection, and maintenance of the aerial device and must be properly stored on the vehicle available for use.
- The importance of a pre-start inspection prior to each shift.
- The Operator must know their responsibilities dealing with problems or malfunctions affecting the operation of the aerial device.
- Overriding safety devices is prohibited, except as approved by the manufacturer.
- Lower controls shall not be used for purposes other than test or recovering the work platform.
- Know what affects stability and the manufacturer's allowable slope and limits.
- Understand the information on placards and decals.
- Work site and workplace inspection.



- Know the safety rules and regulations, such as Part 4, ANSI/IEEE C2, National Electrical Safety Code (applies to utility workers as defined in ANSI/IEEE C2). Other safety rules will apply to use of aerial devices in other industries.
- The Operator must be authorized to operate and know how to prevent unauthorized use.
- The Operator must follow all warnings and instructions.
- All platform occupants must inspect and properly use personal fall arrest equipment.
- Operators must demonstrate proficiency by actual operating the aerial device under the direction of a qualified person. They must operate for a sufficient length of time to show they are proficient in the operation of all control functions of the aerial device and safe use at operating height and reach.
- Know how to properly stow the aerial device for transport and precautions for moving the mobile unit.

### Retraining

- The operator requires retraining based on the following:
  - Evaluation and observation of the operator by the user. The evaluation of the operator shall include evaluating safe and proficient operation of the aerial device.
  - If the operator has a near miss or an accident while operating an aerial device.

### Familiarization

- When directed to operate an aerial device they are not familiar with, a qualified person shall instruct them on the following, prior to operation:
  - The purpose and use of manuals.
  - Warnings and instructions provided by the manufacturer.
  - The purpose and function of all controls.
  - The specific aerial devices operating characteristics and safety devices.

The operator shall operate the aerial device long enough become proficient in actual operation of the aerial device.

A qualified person (operator) may self-familiarize if the items above are completed when the user permits. All Information and bulletins from the manufacturer or installer must be provided to the User without delay. If a Broker is use in leasing the lessor's responsibilities continue.

## Responsibilities of Broker (Section 12)

### Sale through a Broker

The Broker must know that the current owner knows the location and the purchaser's contact information. Verify the Manuals are provided to the new owner. Confirm everyone knows their responsibilities of this standard.

### Leasing through a Broker

The Broker must know that the Lessor knows the location and the Lessee's contact information. Verify the Manuals are provided to the Lessee. Confirm everyone knows their responsibilities stated in the standard.



## SURVEY OF JOB SITE

Appendix (This Appendix is not part of American National Standard A92.2-2009 - but is included for information only.)

Construction and electrical workers are subject to certain hazards that cannot be eliminated by mechanical means and must be controlled by care, common sense and intelligence. Terex South Dakota, Inc. realizes the importance of safety and strongly recommends that prior to commencing any operation, the employer make a survey of the conditions of the site to determine the hazards and the kind and number of safeguards that the employer will install.

The survey should include, but not be limited to, the following:

- (1) Safe access and movement
  - (a) Work areas
  - (b) Walkways, runways and passageways
  - (c) Ladders, stairways and elevators
  - (d) for floor and roof openings
  - (e) Illumination
- (2) Vehicles
  - (a) Roads
    - (1) Turn space
    - (2) Parking area
    - (3) Mud areas
  - (b) Materials storage areas and dump areas
  - (c) Signs and signals to route vehicles on the job
  - (d) Maintenance and repairs of vehicles
- (3) Utilities and service
  - (a) Location of temporary buildings
  - (b) Location and identification of high-voltage lines (identify by signs; move, de-energize or erect barrier to prevent contact)
  - (c) Location of sanitary facilities and drinking water
- (4) Scheduling work for safety
  - (a) Providing hard hats, life belts, goggles, work vests and the like on the job
  - (b) Establishing liaison among contractors to prevent congestion among trades
  - (c) Providing temporary flooring, safety nets and scaffolding where required
- (5) Work Procedures
  - (a) Space
  - (b) Equipment such as cranes, hoists, elevators and trucks
  - (c) Rigging procedures
  - (d) Personal protective equipment
- (6) Tools and equipment
  - (a) Repair, maintenance and care
  - (b) Inspection
  - (c) Supplies of tools for each job

- (7) Workers and foremen
  - (a) Job assignment
  - (b) Training and supervision
  - (c) Number of workers
  - (d) Plans for maintaining interest in safety:
    - (1) Safety bulletins, record charts and posters
    - (2) Recognition for groups or individuals
    - (3) Investigation and reporting on reportable accidents
    - (4) Knowledge of safety orders
    - (5) Safety meetings
    - (6) Specific safety instructions for new employees
  - (e) Establishment of provisions to take immediate action to correct unsafe conditions or acts
  - (f) First aid and medical treatment of injuries