



TEREX

HI-RANGER RMX SERIES

OPERATOR'S MANUAL

This Operator's Manual **MUST BE READ** prior to operating your
RMX SERIES Non-Overcenter Material Handling Articulating Aerial Device.

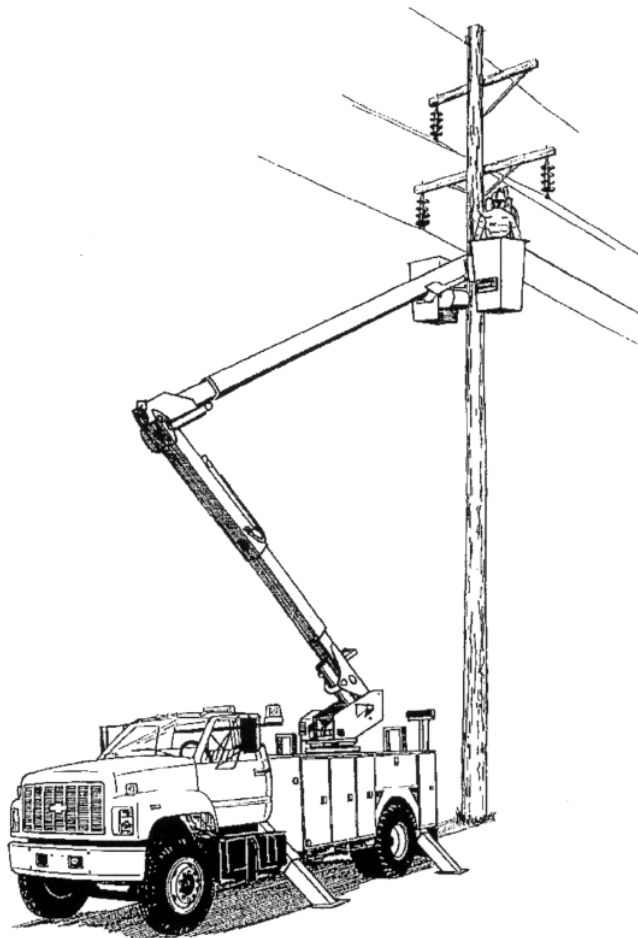

PRINTED IN THE USA
Original Instructions in English

Terex South Dakota, Inc.
500 Oakwood Road
Watertown, SD 57201

TABLE OF CONTENTS

INTRODUCTION	- I
OWNERS, USERS AND OPERATORS	- I
PRODUCT IDENTIFICATION	- I
INTENDED USE	- II
BULLETIN DISTRIBUTION AND COMPLIANCE	- II
CONTACTING THE MANUFACTURER	- II
TRANSFER OF MACHINE OWNERSHIP	- II
SAFETY	- III
HAZARD CLASSIFICATION SYSTEM	- III
PROPERTY DAMAGE MESSAGES	- III
GENERAL SAFETY GUIDELINES	- V
BEFORE OPERATION	- VI
DURING OPERATION	- VII
ELECTRICAL HAZARDS	- VIII
ACCESSORIES	- IX
MATERIAL HANDLING	- X
TRAVELING	- X
MAINTENANCE	- XI
OVERVIEW OF POTENTIAL HAZARDS	- XII
SAFETY RELATED DECALS	- XIV
WHAT IS INSULATED AND WHAT IS NOT INSULATED	- XXIII
ELECTRICAL INSULATION	- XXV
PREVENTION OF ELECTROCUTION	- XXVI
OPERATION ON OR NEAR ENERGIZED CONDUCTOR	- XXVI
SECTION 1	1 - 1
OPERATION GUIDELINES	1 - 1
NOMENCLATURE	1 - 1
CAB CONTROLS	1 - 2
MASTER CONTROL	1 - 2
ENGINE STOP/START (OPTIONAL)	1 - 2
POWER TAKE-OFF (OPTIONAL)	1 - 2
CONTROLS BELOW ROTATION	1 - 4
OPERATOR CONTROLS AND DESCRIPTIONS	1 - 6
UPPER CONTROLS	1 - 7
SINGLE STICK	1 - 7
SINGLE STICK OPERATION	1 - 8
LOWER CONTROLS	1 - 12
TOP CONTROL AND OPTION SHUT OFF	1 - 13
ACCESSORIES	1 - 16
DEMAND THROTTLE	1 - 16
ENGINE STOP/START CONTROL (OPTIONAL)	1 - 16
TWO-SPEED THROTTLE CONTROL (OPTIONAL)	1 - 16
AUXILIARY LET DOWN POWER CONTROL (OPTIONAL)	1 - 16
HYDRAULIC TOOLS (OPTIONAL)	1 - 17
PLATFORM TILT	1 - 18
TILTING OPERATION	1 - 18
PLATFORM LEVELING	1 - 19
OPERATION	1 - 19
PLATFORM ROTATOR (OPTIONAL)	1 - 20



JIB & WINCH OPERATION (OPTIONAL)1 - 21

 HYDRAULIC JIB EXTENSION (OPTIONAL)1 - 22

 DETERMINING LIFT CAPACITIES1 - 23

 AVOID TRAPPED LOOPS1 - 24

 CONDUCTOR LIFTING (OPTIONAL)1 - 24

 PHASE LIFTERS (OPTIONAL)1 - 24

 LOWER BOOM LIFTING ATTACHMENTS1 - 25

BOOM LIFTING EYE MATERIAL HANDLING (OPTIONAL)1 - 26

PERSONNEL AND TRAINING1 - 27

PRE-OPERATION1 - 28

 DAILY PRE-OPERATION CHECKS1 - 28

 JOB SITE SURVEY1 - 30

 OPERATING TEMPERATURE RANGE1 - 30

 WIND SPEED1 - 30

 JOB SITE SETUP1 - 31

 SETTING THE OUTRIGGERS1 - 33

 SETTING UP ON A SLOPING SURFACE1 - 34

 SETTING UP ON A SOFT SURFACE1 - 35

 SETTING UP FOR OPERATION ON SNOW AND ICE1 - 36

 OUTRIGGER / UNIT CONTROL SELECTOR1 - 36

 BOOM INTERLOCK1 - 36

 TORSION BARS (OPTIONAL)1 - 37

 STABILITY1 - 37

OPERATION1 - 38

 BOOM OPERATION1 - 38

 UNSTORE THE BOOM1 - 38

 AERIAL OPERATION1 - 39

EMERGENCY OPERATION1 - 42

 POWER LINE CONTACT ON GROUND1 - 42

 TOP CONTROL AND OPTION SHUT OFF1 - 44

 MANUAL ROTATION1 - 44

 AUXILIARY LET DOWN POWER (OPTIONAL)1 - 44

HYDRAULIC LINE FAILURE1 - 45

 ENGINE FAILURE1 - 47

 HYDRAULIC PUMP FAILURE1 - 47

 CONTROL VALVE FAILURE1 - 47

OPERATIONAL LIMITATIONS1 - 47

 PLATFORM LEVELING SYSTEM1 - 47

 LEAVING THE JOB SITE1 - 48

SECTION 22 - 1

MAINTENANCE GUIDELINES2 - 1

 PREVENTATIVE MAINTENANCE2 - 1

 MAINTENANCE PROCEDURE2 - 1

 ADJUSTMENTS AND REPAIRS2 - 1

 LUBRICATION2 - 2

 GENERAL INFORMATION2 - 2

FREQUENT AND PERIODIC INSPECTION INTERVALS2 - 3

 DAILY2 - 3

 90 DAYS (360 HOURS)2 - 3

 180 DAYS (720 HOURS)2 - 3

 12 MONTHS (1,050 HOURS)2 - 3

 5 YEAR (5,250 HOURS)2 - 3

RMX SERIES

LUBRICATION CHART	2 - 4
END MOUNT	2 - 4
SIDE MOUNT	2 - 5
WINCH ROPE INSPECTION	2 - 6
DAILY ROPE INSPECTION	2 - 7
HOOK INSPECTION	2 - 7
STORAGE PROCEDURE	2 - 8
APPENDIX - A	A - 1
STANDARDS AND REGULATIONS	A - 1
OSHA EXCERPTS: (CLEARANCE DISTANCE)	A - 2
STANDARD HAND SIGNALS	A - 4
APPENDIX - B	B - 1
RESPONSIBILITIES	B - 1
ANSI A92.2-2009 (PARTIAL)	B - 1
SURVEY OF JOB SITE	B - 11



INTRODUCTION

OWNERS, USERS AND OPERATORS

Thank you for choosing Terex South Dakota equipment for your application. User safety is our number one priority and this is best achieved by our joint efforts.

As equipment users and operators, you make a major contribution to safety if you:

1. Comply with OSHA, federal, state, ANSI, local and your company regulations.
2. Read, understand and follow the instructions in this manual and other manuals supplied with this vehicle.
3. Only allow trained operators, directed by informed and knowledgeable supervision, to run the unit.

If there is anything in this manual that is not clear or you believe should be added, please send your comments to:

Manager of Publications
 Terex South Dakota, Inc.
 500 Oakwood Road
 Watertown, South Dakota 57201

You may also contact us by phone at: (605) 882-4000



This is the safety alert symbol. It is used in this manual to alert you to potential personal injury hazards. Obey all safety messages that follow this symbol to avoid possible injury or death.

This manual contains important information on the safe use of your Terex South Dakota equipment. Your failure to read, understand and follow all safety rules, warnings and instructions will unnecessarily expose you and others to dangerous situations. For your safety and the safety of those around you, you **must** operate your Terex South Dakota equipment as instructed in this manual.

This manual shall be stored on the vehicle for access by the operator. The Operators manual is required to be stored on the vehicle by ANSI and OSHA regulations. This manual, along with the AEM Aerial Devices Safety Manual and ANSI A92.2 Manual of Responsibilities for Dealers, Owners, Users, Operators, Lessors and Lessees should be considered a permanent part of your machine and should remain with the machine at all times.

PRODUCT IDENTIFICATION

The serial number is located on the ID plaque. It may be located on the turntable, pedestal or lower boom, depending on options and features. The serial number of the vehicle (VIN) will be different than the serial number for the Aerial Device. Please refer to the Aerial Device serial number when contacting Terex South Dakota for service and parts information. Refer to the ID plaque for capacity and dielectric information.

Serial Number →





INTENDED USE

This machine is intended to be used to lift personnel, along with tools to an aerial work site within the rated platform capacity. If equipped with material handling features it may be used to lift material only within its rated capacity. Use of this product in any other way is prohibited and contrary to its intended use.

BULLETIN DISTRIBUTION AND COMPLIANCE

It is the owners responsibility to comply with all bulletins issued by Terex South Dakota or the vehicle manufacturer. Safety of product users is of paramount importance to Terex South Dakota. Various bulletins are used by Terex South Dakota to communicate important safety and product information to dealers and machine owners. The information contained in bulletins is tied to specific machines using the machine model number and serial number. Distribution of these bulletins is based on the most current owner on record along with their associated dealer, so it is important to register your machine and keep your contact information up to date and changes in ownership. To ensure safety of personnel and the reliable continued operation of your machine, compliance with the information and actions in the bulletins are mandatory.

CONTACTING THE MANUFACTURER

If it is necessary to contact the manufacturer of the machine, supply the unit model number, serial number and your name and contact information. At minimum, the manufacturer should be contacted for:

- Accident Reporting
- Questions regarding product applications and safety
- Standards and regulations compliance information
- Questions regarding product modifications
- Current owner updates, such as changes in machine ownership or changes in your contact information (See Transfer of Machine Ownership below)

TRANSFER OF MACHINE OWNERSHIP

If you are not the original owner of this machine, use the following form to provide information on the ownership change.

This information will insure that you are the owner on record for this machine and you will receive applicable notices and advisories in a timely manner.

You can mail information on changes in ownership to Terex South Dakota, Inc, 500 Oakwood Road, PO Box 1050, Watertown, SD 57201 or email the information to: utilities.warranty@terex.com.

REGISTRATION CARD

Owner's Name			
Address			
City		State	Zip
Signed		Title	
Terex South Dakota, Inc. Model		Ser. #	
VIN #		Customer Truck #	
Check: () Operation & Maintenance Manual Received.			
Date Placed in Service:			
Previous Owner			
Address			

Note: It is the sellers responsibility to provide the Operator's manual to the purchaser. Replacements can be ordered from Terex, South Dakota.

SAFETY

The operator is the single most important factor for safety when using any piece of equipment. Learn to operate your Terex South Dakota equipment in a safe manner.

NOTE: The best method to protect yourself and others from injury or death is to use common sense. If you are unsure of any operation, do not continue until you are satisfied that it is safe to proceed.

HAZARD CLASSIFICATION SYSTEM

This machine contains safety signs to assist in hazard recognition and prevention. The hazard classification system is a multi-tier system used to alert you to potential personal injury hazards. Signal words used with the safety alert symbol indicate a specific level of severity of the potential hazard. To help you recognize important safety information, we have identified **warnings** and **instructions** that directly impact safety.

	This is the safety alert symbol. It is used in this manual to alert you to potential personal injury hazards. Obey all safety messages that follow this symbol to avoid possible injury or death.
---	---

Danger is always used with the safety alert symbol and white letter on red background.

	Indicates a hazardous situation that, if not avoided, will result in death or serious injury.
---	---

Warning is always used with the safety alert symbol and black letters on orange background.

	Indicates a hazardous situation that, if not avoided, could result in death or serious injury.
---	--

Caution is used with the safety alert symbol and black letters on yellow background.

	Indicates a hazardous situation that, if not avoided, could result in minor or moderate injury.
---	---

PROPERTY DAMAGE MESSAGES

The signal word **NOTICE**, shown without the safety alert symbol, is used to address specific practices or draw attention to supplemental information that is not related to personal injury.

Notice does not use the safety alert symbol and text is white italic letters on blue background.

	Indicates information considered important, but not hazard related (e.g., messages related to property damage).
---	---





In addition to maintenance and operating instructions in this manual, the operator must read and understand all the instructions in the following safety guidelines.

1. Study all safety messages and apply them on the job.
2. Modifications to this Terex South Dakota equipment from the original design specifications without written permission from Terex South Dakota are strictly forbidden. A modification may compromise the safety of the Terex South Dakota equipment, subjecting users to serious injury or death. Any such modification will void any remaining warranty.
3. Terex South Dakota reserves the right to change, improve, modify or expand features of its equipment at any time. Specifications, model or equipment are subject to change without notice and without incurring any obligations to change, improve, modify or expand features of previously delivered equipment.
4. Comply with manufacturer's instructions and requirements of current OSHA regulations and ANSI standards.



GENERAL SAFETY GUIDELINES

1. The use of this Aerial Device is subject to certain potential dangers that cannot be protected against by mechanical means. Only the exercise of intelligence, care, and common sense can eliminate these dangers. It is essential to have competent, careful operators who are physically and mentally fit, and thoroughly trained in the safe operation of this Aerial Device. Learn, understand and practice safe use of all equipment and controls - before operating this Aerial Device.
2. Never exceed the rated load capacity. Know the total weight - including the operator, platform liner, tools, and equipment, and/or other items before entering platform.
3. Conduct a thorough pre-operation of the machine and test all functions through their complete cycle before each work shift. Immediately tag and remove from service a damaged or malfunctioning machine.
4. Do not operate this Aerial Device if any interlock or safety device is malfunctioning.
5. Do not bypass or remove any interlock or safety device.
6. Never operate with damaged leveling chain or components.
7. Stop in position if you become aware of any dangerous conditions or hear any unusual noise (such as grinding, cracking or grating) while operating the Aerial Device. Do not move the Aerial Device until the problem has been resolved.
8. Do not operate the Aerial Device if it is not functioning properly or a leak is detected. Repair, document repairs performed and inspect the unit before returning to service.
9. Never operate from the ground controls with personnel in the platform. Operation must be controlled by the platform operator, except in case of an emergency.
10. Keep your Aerial Device control area free of obstructions that may interfere with control operation or physical access to the controls.
11. All ground personnel must be trained in the proper procedures to follow in case of emergency.
12. Do not operate the Aerial Device in an electrical storm.
13. The hydraulic fluid is petroleum based and is flammable.
14. Perform all required maintenance.



**BEFORE OPERATION**

1. Survey the conditions of the work area. Identify situations such as; soft ground, ditches, drop-offs, holes, debris, overhead obstructions, electrical conductors, and underground utilities.
2. Plan the job (tailgate session) and clear the area of bystanders.
3. Set the vehicle parking brake and chock the wheels.
4. Make certain tire pressures are proper for operation.
5. Visually inspect condition of tires, truck suspension, and torsion bars (if equipped) for any damage.
6. The vehicle must be securely parked and stabilized before any operation is performed. If equipped with outriggers, set all outriggers.
7. If not equipped with outriggers, or only one set of outriggers, the truck tires must equally support the weight of the truck. One tire cannot be in a hole or depression.
8. Do not lower outriggers unless you can see that all ground personnel and bystanders are clear of the outrigger path of movement and its ground contact point. Lower all outriggers onto solid footing.
9. Do not place outriggers on ice as slippage may occur regardless of solid footing. Operation on snow or slippery surfaces requires extra care during set up to ensure Aerial Device and vehicle have sufficient traction to prevent sliding.
10. The Aerial Device has been tested per the stability requirements of ANSI A92.2 and may be operated on firm, flat, non-level surfaces up to a 5 degree slope.
11. Ground and/or barricade the vehicle per OSHA and your company rules.
12. Raise and lower booms through a complete cycle using the lower controls daily, before entering platform, looking for any malfunction or problems. If found, shut down immediately.
13. Perform controls inspection before beginning operation. Do not operate with malfunctioning controls.
14. Barricade or cover any overhead electrical lines that may be a potential contact during operation.
15. Inspect and maintain personal protective equipment.
16. Perform inspections and maintenance as specified in the Maintenance Guidelines.
17. Be sure Operator's Manual is on the vehicle.

 DURING OPERATION

1. Never operate the Aerial Device unless you know the location, function, and operation of all the controls, including emergency and accessory operation.
2. Avoid abrupt starts, stops and reversal of direction. Operate all controls slowly for smooth motion.
3. Keep hands off all moving parts to avoid injury.
4. Operator(s) must wear an OSHA approved fall protection system with a lanyard attached to an anchor provided.
5. Wear personal protective equipment such as: Insulated hard hat, rubber gloves with leather protectors, and rubber sleeves. Hearing and eye protection, proper boots and suitable clothing may also be required.
6. Do not place the boom in open traffic lanes, stop traffic or barricade lanes to divert traffic from area.
7. Do not allow boom, platform, or any part of the Aerial Device to contact fixed objects.
8. Do not tie off to an adjacent structure, pole, or other equipment.
9. Never exceed rated capacity of platform for men, tools, and liner if equipped.
10. Do not pass tools, equipment, or other objects between the occupant of the platform and other personnel on poles or other platforms.
11. Do not sit or climb onto edge of platform or use planks, ladders, or other devices for a work position. Always stand with both feet on floor of the platform.
12. Do not wear climbers while in the platform.
13. Do not allow ground personnel under the platform work area.
14. Do not operate with platform leveling malfunctioning.
15. Do not move the vehicle with personnel in the platform.
16. Never tie loads to the platform or booms. Always use lifting attachment when it is necessary to lift or lower an object.
17. Do not lift loads with the Aerial Device if it is not equipped with a lifting attachment.
18. High speed should only be used when moving the platform to an aerial job site. Low speed should be used to move into, or within the aerial job site.
19. Low engine speed, if available, should be used when an extended period of time is going to be spent at an aerial job site.
20. Do not use the platform for lifting material. The platform was designed for lifting personnel only.
21. If, when operating the Aerial Device, you become aware of any dangerous condition, unusual operation, or hear any unusual noise, such as grinding, cracking, or grating sounds-STOP-in position. Do not move the Aerial Device until the problem has been diagnosed and resolved with your safety in mind. No matter how long it may take to get help, waiting is better than a serious or fatal accident.
22. Do not adjust outriggers while platform or booms are raised.
23. Do not operate boom controls while standing on the ground or other structures.





ELECTRICAL HAZARDS

ELECTRICITY OBEYS NO LAW, BUT ITS OWN.

1. Electricity is an ever-present danger when using an Aerial Device. Follow all OSHA, ANSI, state, federal and company rules and regulations when working on or near energized power lines.
2. Always maintain proper clearance from energized power lines. This Aerial Device cannot protect you from phase-to-phase or phase-to-ground contact, which occurs above the insulating boom section.
 - Allow for platform sag, sway or rocking.
 - If any part of boom-tip, everything beyond band of arrows on boom, contacts an energized conductor, the entire boom-tip, including the control handle(s), must be considered energized.
 - If any part of the boom-tip, everything beyond band of arrows on boom, contacts a grounded object, the entire boom-tip, including the control handle(s), must be considered grounded.
3. The booms and boom operators shall be properly insulated from any contact with electrical conductors; including neutral or ground lines, poles, cross arms and guy wires. Utilize proper insulation such as line covers, rubber blankets and hot line tools.
4. The covers and guards on the boom tip components may provide limited electrical protection. DO NOT contact energized conductors and DO NOT operate without covers. Even if covers are plastic or fiberglass, they are not tested or maintained for dielectric protection. Always cover conductors with line hose and maintain distance from conductive items.
5. Never place booms, platforms, or personnel between energized conductors or between an energized conductor and a grounded conductor without proper cover up.
6. Do not wear clothing that when exposed to flames or electric arcs could increase the extent of injury from such exposure.
7. Never operate the Aerial Device in an electrical environment if the fiberglass boom components are damaged, contaminated by moisture or dirt, or otherwise maintained improperly. A daily inspection and an annual dielectric testing of all fiberglass boom components are necessary to maintain the integrity of the insulation.
8. Never allow ground personnel to come in contact with the Aerial Device, vehicle, or vehicle attachments while in operation near energized power lines.
9. When working on or near energized power lines or equipment, the vehicle must be grounded and/or barricaded and considered as energized.
10. Never rely on the fiberglass platform insulation when in the platform. It may contain small unseen cracks that will allow an electrical path into the platform. Always use a platform liner.
11. Never touch the controls or boom tip area when in the platform without using proper protection (wear rubber gloves) while holding any conductors, neutrals, grounds, or other structures.
12. Ground and neutral conductors are current carrying conductors and must be treated as energized (wear rubber gloves).
13. Wear rubber gloves when handling duplex and triplex wires.
14. All tools, accessories and other objects must be contained within the platform when working on or near energized power lines.
15. Check the boom tip area for any exposed conductive material and do not allow boom tip to come in contact with an energized phase or ground.
16. Do not carry or allow a conductor to touch your body. Handle conductors only with rubber gloves even if grounded.
17. All metal components at the boom tip beyond the band of arrows are interconnected. Contact of any part to an energized conductor will energize the entire boom tip, including the controls.
18. Do not attach any metal objects from outside the platform to the inside of the platform. This defeats the purpose of the platform liner.
19. Do not hang metal objects from the platform. It increases the chances of accidental contact.

20. Use only non-metallic tool holders and tool trays.
21. Never use leather work gloves or bare hands on grounded conductors when energized conductors are on the same structure. Wear insulating rubber gloves with leather protectors.
22. Do not lift conductors with the boom tip or platform. Use lifting device with appropriate attachments.
23. Do not bring any conductive object from outside the platform to the inside of the platform. This includes extension cords, guy wires, or conductors. They will eliminate all insulation the machine offers the operator.
24. Do not operate controls while standing on the ground or other structure with booms elevated from stored position. Operating the machine while standing on the ground or other structure could result in electrocution.



ACCESSORIES

1. When working from the platform, only use hydraulic tools equipped with orange hoses marked NON-CONDUCTIVE. The hoses must be kept clean and dry and must be inspected periodically.
2. All accessories must be inspected, maintained and operated with the same care and safety rules that apply to the Aerial Device.
3. Do not use hoses having less than 3000 PSI (20.69 MPa) working pressure ratings.
4. Tools selected for use with this Aerial Device should be closed-center type and operate satisfactorily at 2250 PSI (15.51 MPa) and 8 GPM (30 LPM).
5. If this Aerial Device is equipped with a boom lifting eye, the boom position and lifting capacity must not be exceeded.
6. Personnel or load shall not be allowed in the platform when utilizing the boom lifting eye.
7. If this Aerial Device is equipped with platform tilt, an inspection must be made before entering the platform, to insure all locks and pins are properly in place.
8. Do not place booms or platform under trees or limbs while trimming to avoid possible damage or overloading.
9. Do not operate hydraulic hand tools on high speed for an extended period of time without stopping. Continuous operation can cause overheating and possible damage to the hydraulic system.
10. Do not use lower hydraulic tools when platform or booms are near energized lines.



**MATERIAL HANDLING**

1. Use only a synthetic rope for the winch line. Do not use a wire rope.
2. Do not permit personnel to be under loads being lifted.
3. Do not use winch or load line to raise personnel off the ground.
4. Do not allow rope to contact energized power lines. Do not rely on the rope being non-conductive.
5. Keep the winch rope clean and dry.
6. Inspect the winch rope daily. Do not operate with a damaged or frayed rope.
7. Use a sling. Do not use the winch rope as a sling.
8. Use only hooks with a safety latch.
9. Do not overload. The load chart supplied with each Aerial Device gives the machine capacity.
10. Know the weight of the load you are lifting. Do not guess.
11. The jib and winch are designed for vertical loads only. Center the load line directly above the load before lifting.
12. Do not use the jib and winch to pull or string line.
13. Do not pull poles or objects embedded in the ground. It is impossible to know the force applied and will overload the unit.
14. Lifting the load will cause deflection in the Aerial Device. Allow adequate clearance when applying and removing the load.
15. When using the jib as a line lifter, remove the rope from the sheave.
16. Use only approved and tested hot line tools for lifting energized conductors. Clean and inspect all fiberglass on the conductor lifter before use. Dirty or damaged fiberglass may be conductive.
17. If this Aerial Device is equipped with a boom lifting eye, the boom position and lifting capacity must not be exceeded.
18. Personnel or load shall not be allowed in the platform when utilizing the boom lifting eye.

**TRAVELING**

1. Never travel with personnel in the platform.
2. Never travel with the booms raised.
3. Store booms properly in the boom rest. Lower the lower boom fully before lowering upper boom into the rest.
4. Lock boom(s) in place with hold down system.
5. Keep all tools or other items properly stored on the vehicle while traveling. Otherwise, they may fall onto the roadway.
6. Fully retract the outriggers, store outrigger pads, and wheel chocks.
7. Disengage the power take-off to prevent damage.
8. Ensure platform liner is retained during travel with platform cover or clips to prevent loss.
9. Follow the vehicle manufacturer's instructions for operating the vehicle.

Drive Carefully!





MAINTENANCE



1. Inspect, maintain, and repair this Aerial Device in accordance with the maintenance manual for this device and the maintenance section of this manual.
2. Only authorized and qualified personnel with complete knowledge of this Aerial Device shall be allowed to perform maintenance on this Aerial Device.
3. Never drill holes in the platform.
4. Replace all illegible decals.
5. Do not alter the insulated portion of this Aerial Device. Altering this Aerial Device in any way could reduce its insulating value.
6. Do not search for hydraulic leaks with your hands or any other part of your body.
7. All hoses must meet or exceed the working pressure as stated in the maintenance manual.
8. Only use orange hoses marked NON-CONDUCTIVE for tool hoses, at the boom tip, and areas that bridge the insulation gap.
9. Do not use replacement components that are not equal to the original components.
10. Before doing any work on the hydraulic system, secure the booms and outriggers. Release any hydraulic pressure before attempting repairs or disassembly of hoses, valves, cylinders or any other hydraulic components.
11. Fuel or oil spills may require notification of appropriate Federal, State, or Local officials.
12. Do not operate the Aerial Device after adjustments or repairs until all guards and covers have been reinstalled, trapped air removed from the hydraulic system, safety devices reactivated, and maintenance equipment removed.
13. The subframe, outriggers, and mounting to the vehicle must be inspected following the frequent and periodic inspection intervals for fastener tightness, damaged components and weld inspections.
14. Inspect, maintain, and operate the vehicle and components following the manufacturer's guidelines.

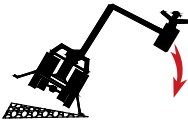

OVERVIEW OF POTENTIAL HAZARDS

The Aerial Device is a heavy moving machine capable of extending its reach vertically and horizontally. There are potential hazards associated with the use of this Aerial Device. These hazards will be minimized if the machine is properly inspected, maintained and operated. The operators shall read and understand this manual and be trained to use the machine in an appropriate and safe manner. Should any questions arise concerning the maintenance or operation of the machine contact Terex South Dakota.

<p>Alert Symbol</p> 	<p>DANGER: Failure to follow will cause serious injury.</p>	<p>Your safety is involved.</p>
<p>Operators Manual</p> 	<p>DANGER: Failure to follow will cause serious injury.</p>	<p>Read and follow operator's manual for safe operation.</p>
<p>Maintenance Manual</p> 	<p>DANGER: Failure to follow will cause serious injury.</p>	<p>Follow all inspection and maintenance to prevent failure.</p>
<p>Electrical Contact</p> 	<p>DANGER: Will cause Serious Injury Maintain minimum clearance from or Death.</p>	<p>Maintain minimum clearance from overhead high voltage power lines. Refer to "Minimum Clearance for High Voltage Lines" chart in Appendix A. Maintain minimum approach distance as appropriate for your qualifications.</p> <p>Do not dig near underground power lines.</p> <p>Use machine only within its electrical rating. Consult the ID Placard for dielectric rating.</p>
<p>Fall</p> 	<p>DANGER: Will cause Serious Injury or Death.</p>	<p>Always wear an OSHA approved fall protection system with lanyard attached to anchor provided.</p>
<p>Unit Overturn</p> 	<p>WARNING: Can Cause Serious Injury or Death.</p>	<p>Do not travel on steep inclines or crosswise to grades.</p> <p>Do not travel on soft or unstable ground or close to unsupported excavations.</p> <p>All tires must remain on the ground.</p> <p>Set outriggers (if equipped) so indicator remains in green area.</p>

<p>Crushing</p> 	<p>WARNING: Will Cause Serious Crushing Injury.</p>	<p>Do not operate outriggers unless you can verify all personnel and obstructions are clear. Operator must watch the outrigger while in motion.</p>
<p>High Pressure Air or Fluid</p> 	<p>WARNING: Can Cause Serious Injury or Death.</p>	<p>Relieve pressure on hydraulic and pneumatic systems before loosening hoses or connections. Do not check for leaks with your hand.</p>
<p>Lanyard Attach.</p> 	<p>WARNING: Failure to Attach Can Cause Serious Injury or Death.</p>	<p>Attach lanyard to the anchor provided.</p>



SAFETY RELATED DECALS

Safety signs are designed and fitted to the product to warn of possible dangers, and **MUST** be replaced immediately if they become unreadable or lost. If the product is repaired and parts have been replaced on which safety signs were fixed, be sure new safety signs are fitted before the product is put into service. Use mild soap and water to clean safety signs - **DO NOT** use solvent based cleaners, as they may damage the safety sign material.



Operating this equipment without all safety and control decals in place can be hazardous.

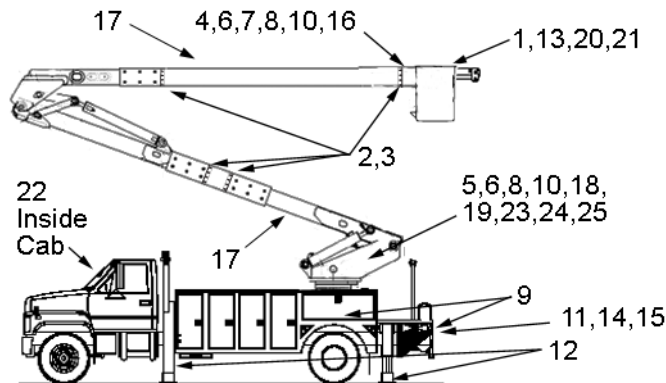

NOTE: *Use decal 419265 and 465703 when Aerial Device is not certified in accordance with latest ANSI A92.2 revision or booms are not insulated.

ITEM #	DECALS	QTY.	PART #
1.	PLATFORM NOT INSULATED	1	47988
2.	ARROWS	18'	H21503
3.	NOT INSULATED BEYOND ARROWS	8	402236
4.	READ CAREFULLY	1	414590
5.	FAILURE TO OBEY	1	419262
6.	ELECTROCUTION HAZARD	2	419263
7.	FALLING FROM PLATFORM	1	419264
8. *	ELECTROCUTION HAZARD - NOT INSULATED	2	419265
9.	ELECTROCUTION HAZARD - KEEP CLEAR	3	419266
10.	UNTRAINED OPERATOR	2	419267
11.	OUTRIGGER - CRUSHING - DO NOT OPERATE	2	419268
12.	OUTRIGGER - CRUSHING - STAND CLEAR	4	419269
13.	CONDUCTIVE HOSE	1	419270
14.	OVERTURNING HAZARD	2	458696
15.	SLOPE INDICATOR	2	486277
16.	CONTROLS NOT INSULATED	2	463602
17. *	NOT INSULATED	4	465703
18.	ANSI WARNING	1	468476
19.	MAINTENANCE RECORD	1	489119
20.	LANYARD ATTACHMENT, X2 (depending on boom tip option)	1	495440
21.	LANYARD ATTACHMENT, X1 (depending on boom tip option)	1	495441
22.	TRUCK COMPUTER	1	495845
23.	FALL HAZARD - MAINTENANCE	1	495892
24.	PINCH POINT	2	H23451
25.	ESCAPING FLUID UNDER PRESSURE	1	H23877

1.

THIS BASKET, WITHOUT AN INSULATING LINER, IS NOT CERTIFIED AS AN ELECTRICAL INSULATING BARRIER.

47988D

2. & 3.

! DANGER

BOOM IS NOT INSULATED BEYOND ARROWS

AVOID CONTACT WITH ENERGIZED LINES.

402236A

4.

! DANGER

READ CAREFULLY

- OCCUPANTS OF THE BASKETS OF THIS AERIAL DEVICE HAVE ABSOLUTELY NO ELECTRICAL PROTECTION FROM CONTACT BY THE HUMAN BODY WITH TWO ENERGIZED CONDUCTORS OR BETWEEN AN ENERGIZED CONDUCTOR AND A GROUNDED CONDUCTOR.
- It makes no difference if this contact is accidental or deliberate or whether contact is made through metallic parts of the basket, basket support, metal tools or equipment brought into the basket. The insulating components of this aerial device do not offer protection in the event of such contact.
- Proper conductor cover up, insulated sleeves and gloves shall be worn when working near energized lines or equipment.

DEATH OR SERIOUS INJURY WILL RESULT FROM SUCH CONTACT OR INADEQUATE CLEARANCE

414590A

5.

! DANGER

FAILURE TO OBEY THE FOLLOWING WILL RESULT IN DEATH OR SERIOUS INJURY

- For stationary operation, truck must be securely parked, driveline disengaged, and Aerial Device properly stabilized prior to operation.
- To avoid tip-over, outriggers (when so equipped) must be properly extended on a solid level surface.
- Operate all controls slowly for a smooth platform motion and make sure controls are returned to neutral after desired operation.
- Crew must use proper personal and other protective equipment.
- Never load beyond rated capacity.
- Never operate Aerial Device with personnel under boom or load.
- Never move the truck until the booms and outriggers are in a properly stowed position and secured.
- Refer to the operator's manual for complete instructions. If missing, replace manual.

419262

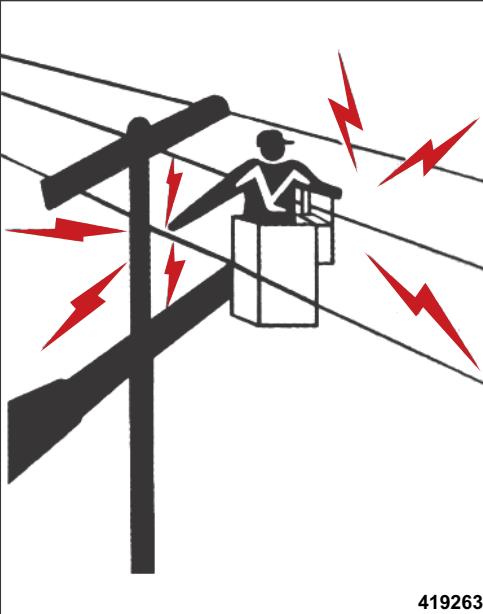

6.

<p>! DANGER</p>	
<p>ELECTROCUTION HAZARD</p> <p>DEATH OR SERIOUS INJURY WILL RESULT FROM CONTACT WITH OR INADEQUATE CLEARANCE TO ELECTRICAL POWER LINES AND APPARATUS</p> <ul style="list-style-type: none"> • Maintain safe clearances from electrical power lines in accordance with applicable government regulations. Allow for boom, platform, electrical line and load line sway. • This machine does not provide protection from contact with or proximity to an electrically charged power line when you are in contact with or in proximity to another power line. 	

419263

7.

<p>! DANGER</p>	
<p>FALLING FROM PLATFORM WILL RESULT IN DEATH OR SERIOUS INJURY</p> <ul style="list-style-type: none"> • Platform personnel must wear an OSHA approved fall protection system with lanyard attached to anchor provided. • Platform doors, if provided, must be securely latched. 	

419264A

8.

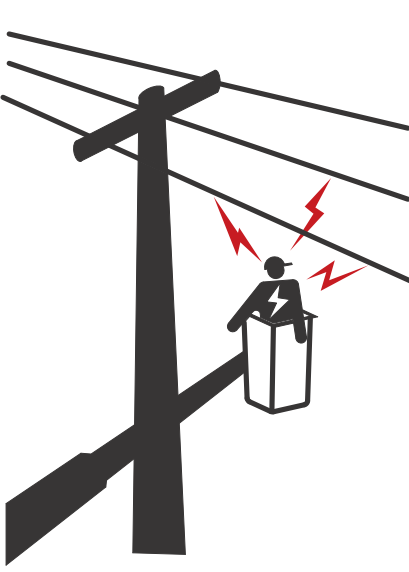
<p>! DANGER</p> <p>ELECTROCUTION HAZARD THIS MACHINE IS NOT INSULATED DEATH OR SERIOUS INJURY</p> <p>Will result from contact with or inadequate clearance to electrical power lines and apparatus</p> <ul style="list-style-type: none">● Maintain safe clearance from electrical power lines in accordance with applicable government regulations. Allow for boom, platform, electrical line and load line sway.● This machine does not provide protection from contact with or proximity to an electrically charged power line.● Boom and platform must be kept below all electric power lines.● Do not use for work on electric power lines.	 <p>419265A</p>
---	---

9.

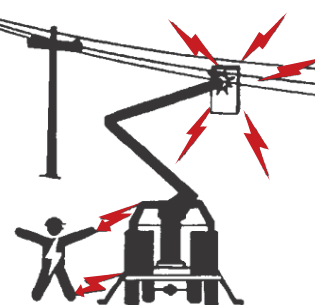
<p>! DANGER</p> <p>ELECTROCUTION HAZARD DEATH OR SERIOUS INJURY WILL RESULT FROM CONTACT WITH THIS MACHINE, TRUCK OR TRUCK ATTACHMENTS IF THEY SHOULD BECOME ELECTRICALLY CHARGED.</p> <p>KEEP CLEAR OF TRUCK AND LOAD</p>	 <p>419266</p>
---	---



10.

DANGER

AN UNTRAINED OPERATOR
SUBJECTS HIMSELF AND
OTHERS TO
DEATH OR SERIOUS INJURY

YOU MUST NOT OPERATE
THIS MACHINE UNLESS

- You have been trained in the safe operation of this machine.
- You have read, understand and follow the safety and operating recommendations contained in the machine manufacturer's manuals, safety signs attached to equipment, your employer's work rules and applicable government regulations.
- You are sure the machine is operating properly and has been inspected and maintained in accordance with manufacturer's manuals.
- You are sure that all safety signs, guards and other safety features are in place and in proper condition.

419267

11.

DANGER

OUTRIGGER CONTACT
WILL CAUSE
SERIOUS CRUSHING INJURY

- Do not operate any outrigger unless you or a signal person can see that personnel and obstructions are clear of the outrigger and its contact point.

419268A

12.



DANGER



OUTRIGGER CONTACT WILL CAUSE
SERIOUS CRUSHING INJURY
STAND CLEAR

419269

13.

DANGER

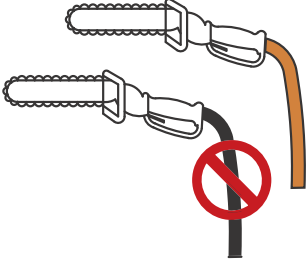

ELECTROCUTION HAZARD
FIRE HAZARD

USE ONLY ORANGE, NON-CONDUCTIVE HOSE FOR TOOL, PLATFORM AREA, AND INSULATED SECTIONS.

FAILURE TO DO SO MAY CAUSE
DEATH OR SERIOUS INJURY.

419270A

14.

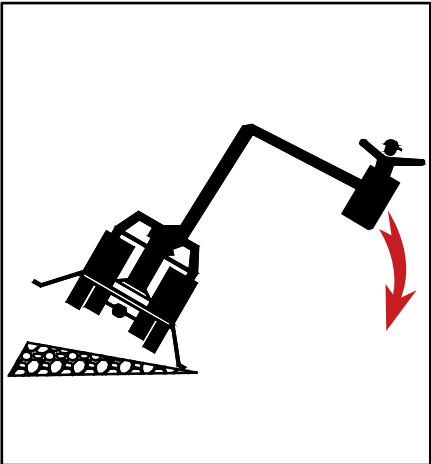

! DANGER

**OVERTURNING HAZARD
DEATH OR SERIOUS INJURY**

May result from overturning machine

- This unit has been tested for stability on a maximum slope of 5 degrees.
- Working on slopes that exceed 5 degrees may result in truck tipping over.
- All tires must remain on the ground.
- Position or park truck so indicator is in the green area.
- Set Outriggers (if equipped) so indicator remains in green area.

458696A

15.

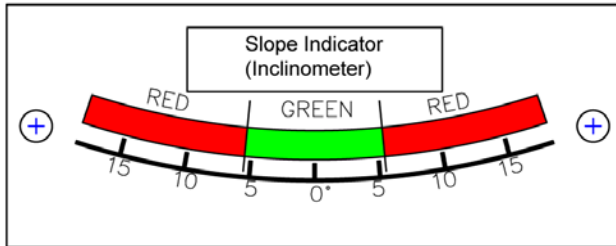

16.

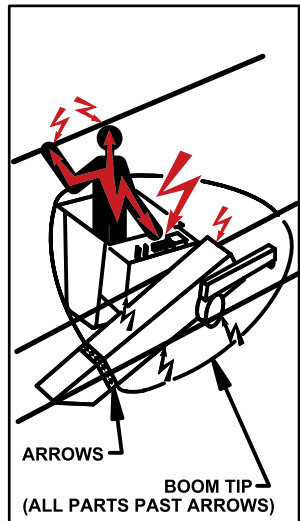

! DANGER

ELECTROCUTION HAZARD

CONTROLS ARE NOT INSULATED OR ISOLATED

All metal at boom tip is electrically connected.
Operator contact with ANY, live or grounded, line or object while operator touches CONTROLS or BOOM TIP COMPONENTS and boom tip contacts any other line or object can result in

DEATH OR SERIOUS INJURY

Comply with OSHA, ANSI, & NESC requirements

- Maintain proper CLEARANCE to all lines and objects
- Wear Personal Protective Equipment: Fall protection; Eye protection; Insulating: gloves, sleeves, and hard hat; & Special clothing
- Cover all lines with insulated line hose or insulating blankets
- DO NOT Depend on machine covers for insulation

Plastic or fiberglass covers offer limited electrical insulation.
Covers are NOT tested, certified, or maintained as insulating.

463602A



ARROWS
BOOM TIP
(ALL PARTS PAST ARROWS)

17.

NOT INSULATED

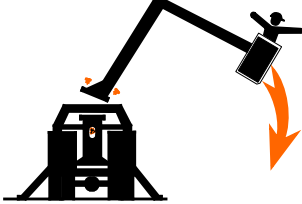

23.

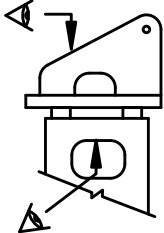
 WARNING	
	
FALL HAZARD FAILURE TO PROPERLY MAINTAIN THIS MACHINE CAN LEAD TO STRUCTURAL FAILURE AND RESULT IN DEATH OR SERIOUS INJURY	
 	<p>Read and follow all inspection and maintenance schedules in the manual(s). Do not operate machine unless all deficiencies are corrected. Proper maintenance and inspection is required for safe and reliable operation.</p> <p>Daily Visual Inspection</p> <ul style="list-style-type: none">- all structural components and welds- all fasteners for damage, signs of looseness or missing from required location.- damaged or missing covers or guards <p>Check torque on fasteners as required in manual(s). Fasteners include turntable to rotation bearing, pedestal to rotation bearing, cylinder and boom pivot pins and retainers, subframe mounting bolts and leveling components.</p> <p>The Aerial Device or Digger Derrick you are operating must be maintained by a qualified person.</p>
<small>495892A</small>	



24.



25.



WHAT IS INSULATED AND WHAT IS NOT INSULATED

The term insulated means separated from other conductive surfaces by a dielectric substance (including air space) offering a high resistance to the passage of current (from OSHA 1926.960).

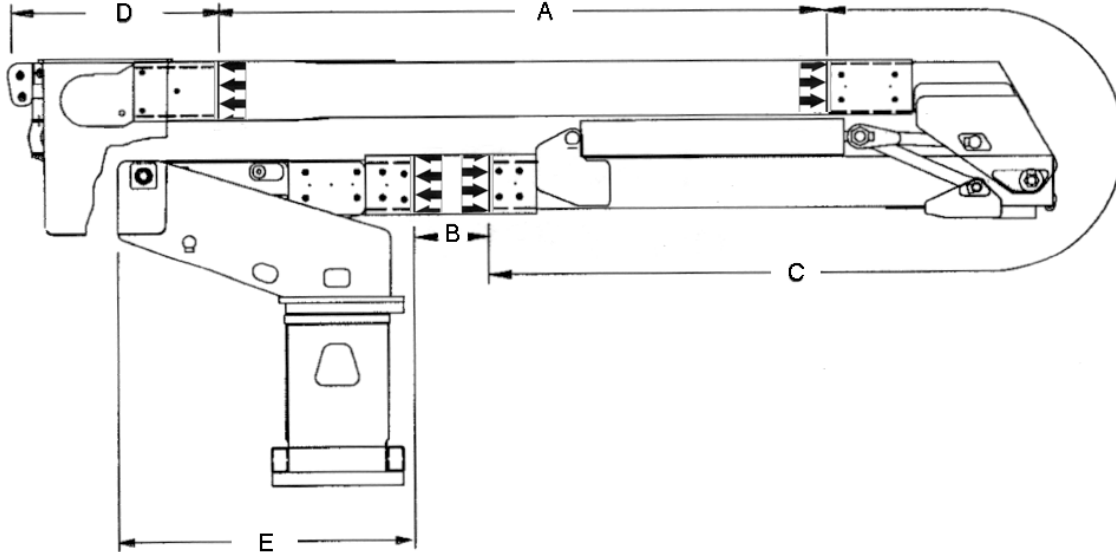

Area A. Upper Boom Insulation, provides an insulating area between area D and earth ground when in properly maintained condition.

Area B. Lower Boom Insert, provides an insulating area between area C and area E when in properly maintained condition.

Area C. Elbow, does not provide insulation. This area contains conductive materials such as cylinders, pins, boom structure, and other metal components. The operator shall not allow any portion of this area to come in contact with an energized phase, ground conductor, or grounded objects. Proper protective devices shall be used on all conductors. Any contact with a ground and phase line or between two-phase conductors will create a hazard.

Area D. Boom Tip, does not provide insulation. This area contains conductive materials such as control levers, un-insulated platform(s), platform support shaft, boom-tip structure and other metal components. These objects must be considered connected. The operator shall not allow any portion of this area to come in contact with an energized phase, ground conductor or grounded objects. Proper protective devices shall be used on all conductors. The operator shall not make contact with any portion of this area when working on or near an energized phase, ground or grounded objects, unless wearing proper protective clothing such as rubber gloves and sleeves rated at the voltage of the lines. Any contact with a phase line, a ground and phase or between two-phase conductors will create a hazard. Accidental contact of any portion of area D to an energized conductor will energize the entire area D.

NOTE: A properly maintained platform liner will only provide protection for those portions of the body or materials entirely within the liner and not in contact with any part of area D.

Area E. Does not provide insulation. This area contains conductive materials such as cylinders, pins, boom structure, turntable, pedestal and other metal components. The operator shall not allow any portion of this area to come in contact with an energized phase, ground, or grounded objects. Proper protective devices shall be used on all conductors. This area is attached to the vehicle and connected trailers, which must be barricaded and/or grounded through an approved ground system when working in the vicinity of energized conductors. Any contact with a phase or between two-phase conductors will create a hazard.

WHAT IS INSULATED AND WHAT IS NOT INSULATED



WHAT IS INSULATED AND WHAT IS NOT INSULATED

! The insulating boom section only prevents current from passing from the band of arrows at the boom tip to the lower band of arrows. All components above and below that area must be considered conductive.

! The boom tip is everything past the upper band of arrows. All boom tip components are structurally and electrically connected. Contact with any part of the boom tip will energize the entire boom tip including, jib, winch, and platform support structure.

! Death or serious injury to the operator or ground personnel can occur if any part of the boom or boom tip contacts an energized conductor, ground line, grounded line, or OBJECTS. Proper clearance must be maintained.

! You must always cover the line and wear rubber gloves with rubber sleeves and an approved hard hat when any part of the Aerial Device is working on or near energized lines or conductors even when working on a grounded line, neutral line, or ground line.

! Neutral, static and ground lines are current carrying conductors and require proper handling. Treat them as energized.

! You must read the operators manual to fully understand the protection the Aerial Device will give you.

! Anytime the platform occupant(s) contact two items at different potential without proper personnel protective equipment, their body may become a path for electric current, and they may be electrocuted. This includes touching the controls, any tools, or items on the boom tip while also contacting a line or ground.

ELECTRICAL INSULATION

Operation on or near energized lines is extremely hazardous unless proper OSHA and ANSI work rules are followed. The operation of this Aerial Device in proximity to high voltage electrical lines involves several hazards to the operator of the Aerial Device, ground personnel and bystanders on the ground. These hazards are as follows:

1. Contact of the operator with a single energized line will allow current to pass through the operator's body to ground by means of an all-metal boom structure, unless the operator is insulated from ground.
2. Contact of the operator with two energized lines or one energized line and a grounded conductor will cause electrocution, even if the operator is insulated from ground by the Aerial Device.

	The fiberglass upper boom, fiberglass lower boom insert and fiberglass platform, including its components, do not protect the platform operator from injury in case of contact between two energized lines, or between an energized line and a grounded conductor.
---	--

	Working around electrical power lines is covered by ANSI and OSHA Regulations. To reduce danger to the operator and ground personnel or bystanders on the ground, understand and follow all rules.
---	--

IMPORTANT: Only caution and proper work practice on the part of the occupant(s) will protect the occupant(s).

3. Contact of a metal section of the boom with a wire, below the insulation of the boom, will energize the Aerial Device and the vehicle causing electrocution to ground personnel and bystanders standing on the ground and touching the vehicle.

	Ground personnel should never touch the Aerial Device, the vehicle or an attached trailer while the Aerial Device is in operation near electrical power lines even though the Aerial Device has an insulated boom and lower boom insert.
--	--

	Avoid contact of any metal part or equipment below the insulated section of the lower boom with an electrical power line. Serious injury or death could result.
---	---

4. Contact of the boom with a wire may break the wire or burn the wire in two, which will cause a hazard to ground personnel and bystanders below.

Some protection against Hazard No.1 is furnished by the fiberglass upper boom. When PROPERLY MAINTAINED, the insulated boom protects platform personnel in case they were to contact a SINGLE energized power line within the qualification voltage limit stamped on the nameplate. However, this protection can be nullified by accumulation of dirt and moisture on or in the boom. Operator safety requires a regular electrical testing program.

Some protection against interphase contact, Hazard No. 2, is offered by the platform liner. The platform liner is used for interphase protection of the lower half of the body only. Only caution on the part of platform personnel and use of proper protective equipment will protect the upper half of their body from this hazard. Any conductive object in the platform liner, which protrudes above the liner, will eliminate any protection the liner may offer.

Limited protection of ground personnel against contact of the steel elbow area or lower boom with an energized line, Hazard No. 3, is offered by the insulated lower boom and a proper grounding system. The lower boom insert, like the insulated upper boom, must be regularly tested and cleaned to ensure continued safety. Contact with an energized line below the lower boom insert will energize the vehicle and the ground around the vehicle. Anyone close to the vehicle may be injured. A ground cable to a suitable ground may prevent damage and injury. Ensure ground cables are making good contact with the vehicle and ground rod or neutral and are not coiled on reel or storage hooks. A properly grounded vehicle does not guarantee protection for people on the ground. It's purpose is to engage the line protection, fuse or breakers as quick as possible to limit damage. A lethal voltage may still exist between the vehicle and ground.

There is no protection against Hazard No. 4. Caution must be exercised continually to avoid making contact with an energized line, which, if broken or burned, may drop to the ground and cause injury to ground personnel and any bystanders.

WHAT IS INSULATED AND WHAT IS NOT INSULATED



PREVENTION OF ELECTROCUTION

1. NEVER rely on fiberglass dielectric properties around power lines with moisture present on the platform(s) and booms. If the Aerial Device is stored outdoors, protect the platform(s) and booms from the weather with a cover when not in use. To preserve dielectric properties, fiberglass must be kept clean and dry.
2. REMEMBER, auxiliary equipment, such as electrical cords, communication lines, and conductive tools, that bridge the insulation between the operator and ground, render the insulation useless.
3. REMEMBER your Aerial Device cannot protect you against contact between two-phases, between one phase and a pole or a grounded conductor. Never work between electrical lines unless the proper precautions are observed.
4. DO NOT allow any ground personnel or bystanders to touch the Aerial Device, the vehicle, or an attached trailer while the Aerial Device is in operation near electrical power lines, even if the Aerial Device has an insulated lower boom.
5. Have boom insulation TESTED annually, in accordance with established rules and regulations.
6. CONTROLS are not insulated and are interconnected to all other conductive components at the boom tip. DO NOT contact any conductor or wire while touching controls, unless wearing insulating rubber gloves rated for the voltage.
7. DO NOT depend on plastic covers, fiberglass covers, or guards installed on the Aerial Device for dielectric protection from contact with a line or ground. The covers may provide some protection, but they are not tested to guarantee dielectric strength. Hidden damage, dirt and contamination will make them conductive. Use line covers or blankets when closer than the minimum approach distance.

OPERATION ON OR NEAR ENERGIZED CONDUCTOR

When working ON OR NEAR ENERGIZED CONDUCTORS (either known or suspected), special conditions arise. While the fiberglass upper boom provides a high degree of electrical insulation between the platform and the vehicle, there are several things it WILL NOT DO:

- IT WILL NOT PROVIDE PHASE TO PHASE PROTECTION.
- IT WILL NOT PROVIDE PHASE TO GROUND PROTECTION THROUGH STATIC LINES OR GUY WIRES.
- IT WILL NOT PROTECT THE VEHICLE FROM BEING ENERGIZED IF STEEL BOOMS CONTACT A LOWER LEVEL SECONDARY POWER SOURCE.

The fiberglass boom must be kept clean and dry for this type of work.

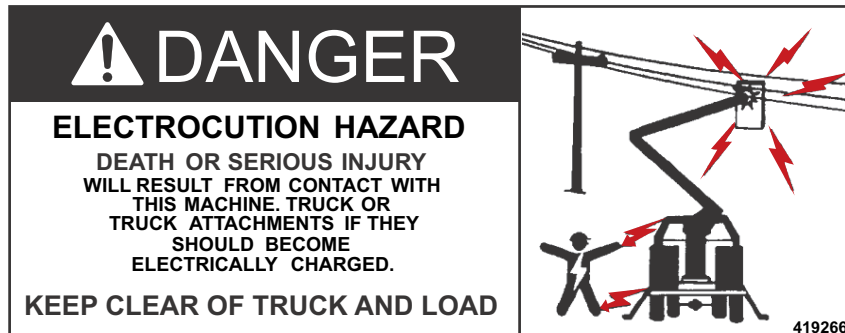

RMX SERIES

	<p>The fiberglass boom and platform liners must be dielectrically tested periodically to insure the insulating properties are being maintained.</p> <p>Do not assume that it is so.</p>
	<p>Ground personnel must be warned to stay away from vehicle in case of accidental boom contact between conductor and metallic portion of boom, which will cause serious injury or death.</p>
	<p>The fiberglass upper boom, fiberglass lower boom insert and fiberglass platform, including its components, do not protect the platform operator from injury in case of contact between two energized lines or between an energized line and a grounded conductor.</p>
	<p>Upper Controls can become energized if any part of the boom-tip past the band of arrows on the boom contacts a conductor. The Aerial Device upper control station has metal parts that are necessary to provide the structural support for the components. These metal parts at the boom-tip are interconnected. The main shaft that supports the platform(s) and controls also support other load carrying options that can be added to the boom-tip.</p>
	<p>Do not depend on Aerial Device covers for insulation. Plastic or fiberglass covers offer limited electrical insulation. Covers are not tested, certified or maintained as insulation.</p>
	<p>All conductors including grounds and neutral lines are current carrying conductors and must be treated as energized unless properly grounded and tested.</p>
	<p>The fiberglass upper and lower boom, in a well maintained condition, provides electrical insulation between the upper boom-tip and the vehicle to ground. This fiberglass will not protect the platform operator if any portion of the boom tip or upper arm control station, including options is brought into contact with an energized or non-energized conductor and the operator is in contact with a different potential, such as grounded non-energized conductor. This type of contact can energize or ground the controls because all components of the upper control station are interconnected. The fiberglass will not provide protection for the operator in phase to phase contact or a phase to ground wire contact above the upper boom insulation. Nor will it protect the vehicle from becoming energized if the steel boom section below the lower boom insert, if so equipped, is brought into contact with an energized conductor. Serious injury or death could result.</p>

WHAT IS INSULATED AND WHAT IS NOT INSULATED



⚠ DANGER

READ CAREFULLY

- OCCUPANTS OF THE BASKETS OF THIS AERIAL DEVICE HAVE ABSOLUTELY NO ELECTRICAL PROTECTION FROM CONTACT BY THE HUMAN BODY WITH TWO ENERGIZED CONDUCTORS OR BETWEEN AN ENERGIZED CONDUCTOR AND A GROUNDED CONDUCTOR.
- It makes no difference if this contact is accidental or deliberate or whether contact is made through metallic parts of the basket, basket support, metal tools or equipment brought into the basket. The insulating components of this aerial device do not offer protection in the event of such contact.
- Proper conductor cover up, insulated sleeves and gloves shall be worn when working near energized lines or equipment.

DEATH OR SERIOUS INJURY WILL RESULT FROM SUCH CONTACT OR INADEQUATE CLEARANCE

414590A

⚠ DANGER

ELECTROCUTION HAZARD

CONTROLS ARE NOT INSULATED OR ISOLATED

All metal at boom tip is electrically connected.
Operator contact with ANY, live or grounded, line or object while operator touches CONTROLS or BOOM TIP COMPONENTS and boom tip contacts any other line or object can result in

DEATH OR SERIOUS INJURY

Comply with OSHA, ANSI, & NESC requirements

- Maintain proper CLEARANCE to all lines and objects
- Wear Personal Protective Equipment: Fall protection; Eye protection; Insulating: gloves, sleeves, and hard hat; & Special clothing
- Cover all lines with insulated line hose or insulating blankets
- DO NOT Depend on machine covers for insulation
Plastic or fiberglass covers offer limited electrical insulation. Covers are NOT tested, certified, or maintained as insulating.

463602A



SECTION 1
OPERATION GUIDELINES

NOMENCLATURE

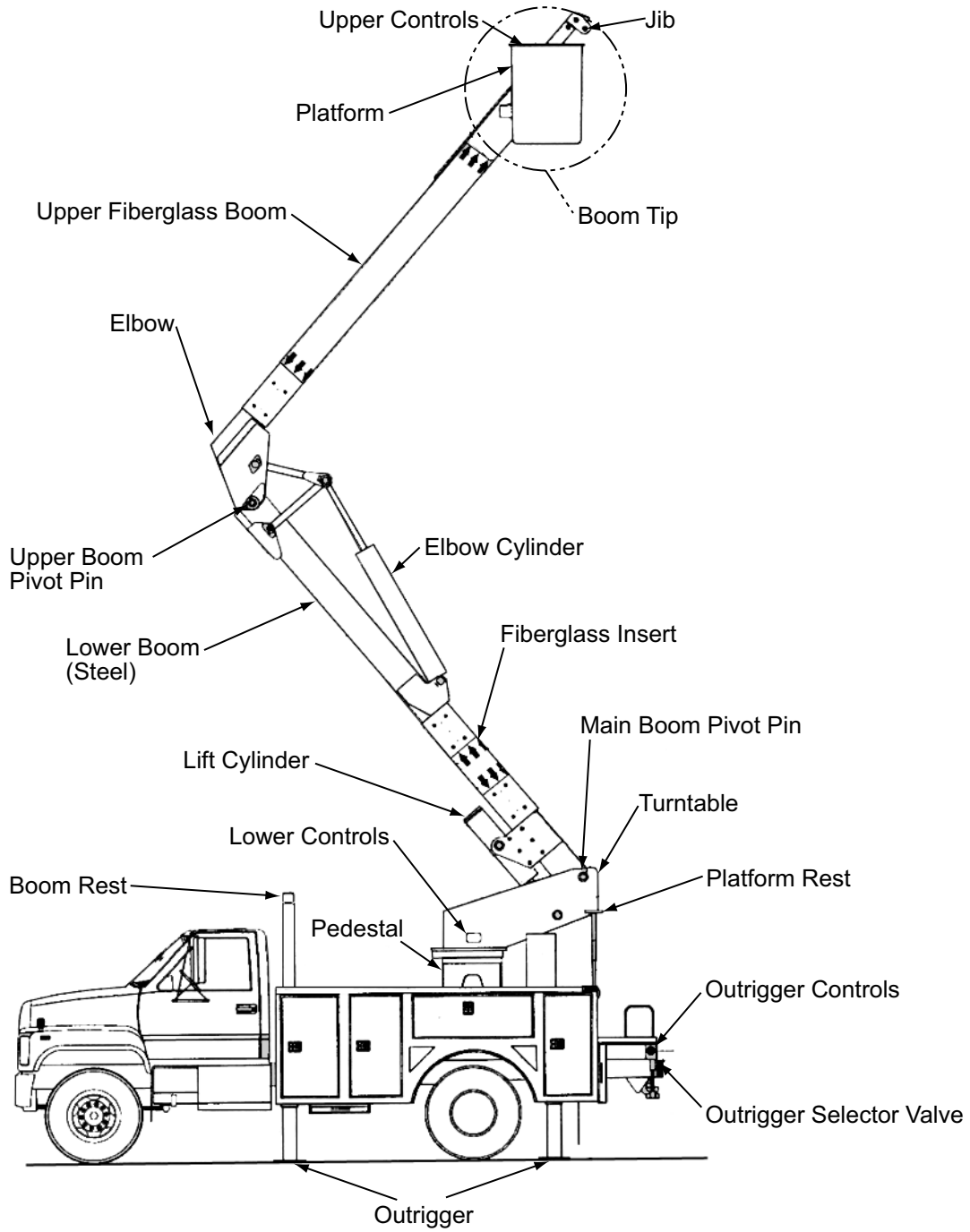

CAB CONTROLS

MASTER CONTROL

The master control is located in the cab of the vehicle and has a toggle switch on the dashboard. The toggle switch is used to energize the engine stop/start system and the throttle control options, which may be located in the cab, at the platform, or on the pedestal. When the light is lit, the toggle switch is energizing these systems. If the unit is not equipped with engine stop/start, two-speed throttle or 12V hydraulic power, it will not require a master control.



CAB CONTROLS

ENGINE STOP/START (OPTIONAL)

The engine stop/start is a push button control and is usually mounted on the dashboard of the vehicle. To start the engine press the button and hold in for a moment until the engine starts, then release. To stop, or shut off, the engine, press the button again.



Be sure the vehicle transmission is in neutral, the brakes are applied and the wheels are chocked before engaging the PTO or using the engine stop/start.

POWER TAKE-OFF (OPTIONAL)

The power take-off (PTO) is a gearbox used to transmit power from the vehicle transmission to the hydraulic pump, which provides hydraulic oil for the Aerial Device functions. The power take-off control can be a switch on the dash, for electric control systems, or a "push-pull" knob, (usually mounted on the cab floor) and a red light mounted in the vehicle dashboard. When lit, this red (PTO) dash light indicates the PTO is activated and serves to remind the operator not to drive the vehicle with the PTO engaged.





Driving with the PTO engaged may damage both the pump and the PTO.

To engage the power take-off properly, refer to the PTO manufacturer's operating instructions and be sure the manufacturer's operating decals are posted in the cab with the PTO controls.

NOTE: Typical controls are illustrated. Each installation may be unique depending on configuration and options.

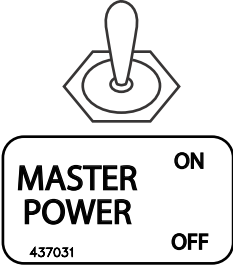
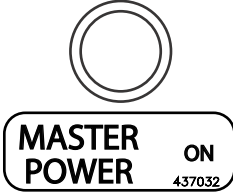
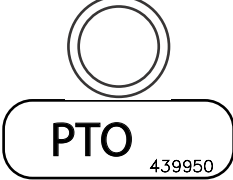
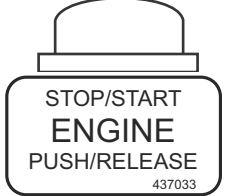
CAB CONTROLS OPERATION

<p>Master Power</p>		<p>Push "ON" to activate remote electrical systems.</p> <p>Push "OFF" to deactivate remote electrical systems.</p> <p>May also engage PTO.</p>
<p>Master Power Light</p>		<p>Red light; when lit indicates master power is activated.</p>
<p>PTO Light</p>		<p>Red light; when lit indicates PTO is engaged.</p>
<p>Engine Stop/Start (Optional)</p>		<p>Push and hold to start engine.</p> <p>Release when engine starts.</p> <p>Push and release to stop engine.</p> <p> Can also be used to stop the Aerial Device in an emergency.</p>



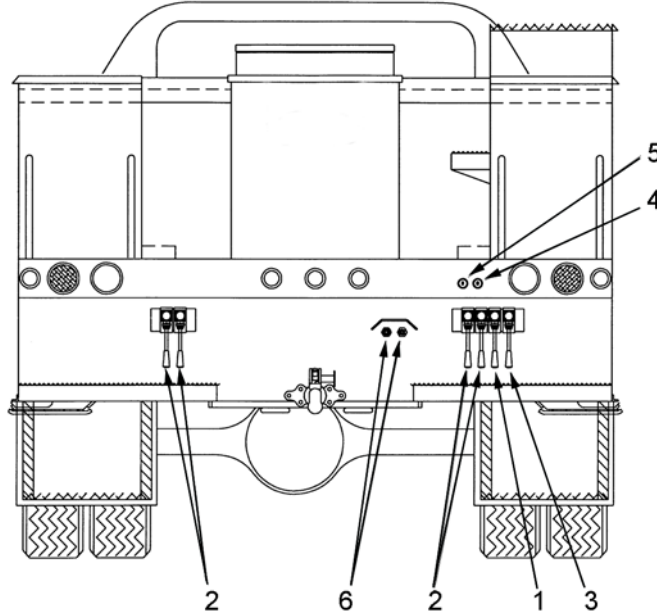

CONTROLS BELOW ROTATION

These controls are usually mounted at the rear of the vehicle chassis. The controls may include outriggers, hydraulic tools, control selector, engine stop/start, two-speed throttle, and auxiliary let down power. The controls shown are generic. The actual location and functions will vary depending on the purchasers requirements and options ordered. Refer to the control decals on unit for proper operation.





UTILITY VEHICLE CONTROL LOCATIONS

ITEM	CONTROL	DESCRIPTION
1.	Selector (Optional)	A selector valve that allows operation of boom functions when in the "UP" position and operation of the outriggers when in the "DOWN" position.  The Selector will function as an emergency stop by taking oil flow away from the active controls.
2.	Outrigger Controls (Optional)	Allows extending and retracting of outriggers.
3.	Hydraulic Tools (Optional)	Directs oil flow to the tool when connected to the quick couplers.
4.	Engine Stop/Start (Optional)	Allows operator to stop and start engine.
5.	Two-Speed Throttle (Optional) Auxiliary Let Down Power (Optional)	Two-speed throttle provides two engine speeds, low and high, with engine running. Low speed is engine idle. Auxiliary let down power provides hydraulic power to lower and stow the Aerial Device in the event of a prime power source failure.
6.	Hydraulic tool couplers (Optional)	Quick couplers for hydraulic tool connection.

 The decals are an integral part of this Aerial Device. If the decals are illegible, they must be replaced.

 Always operate controls slowly and deliberately for smooth movements. Rough handling is never excusable and may cause damage to the Aerial Device and endanger the operator.

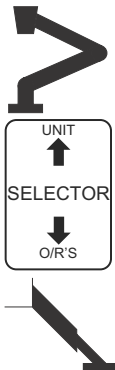
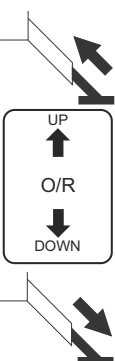
CONTROLS BELOW ROTATION OPERATION

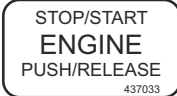
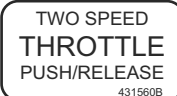
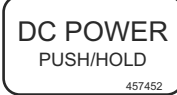
1.	Selector		<p>Move handle up to activate "UNIT" system.</p> <p>! The Selector will function as an emergency stop by taking oil flow away from the active control.</p> <p>Move handle down to operate outrigger system "O/R'S".</p>
2.	Outrigger Controls		<p>Move handle "UP" to raise outrigger.</p> <p>Move handle "DOWN" to lower outrigger.</p>
3.	Hydraulic Tools (Optional)		<p>Return handle to center position to turn off.</p> <p>NOTE: Turn tool "OFF" before operating other functions.</p> <p>Move handle to energize tool quick couplers in direction required. "ON" direction energizes male coupler.</p>
4.	Engine Stop/Start (Optional)		<p>Push and hold to start engine. Release when engine starts.</p> <p>Push and release to stop engine.</p> <p>! Can also be used to stop the Aerial Device in an emergency.</p>
5.	Two-Speed Throttle (Optional)	 	<p>With engine running, the throttle is activated.</p> <p>Push and release to increase engine RPM.</p> <p>Push and release to return to engine idle.</p> <p>With engine "OFF", the auxiliary let down power is activated.</p> <p>Push and hold to turn on auxiliary let down power.</p> <p>Release to shut off auxiliary let down power.</p>
<p>NOTE: *Can be included with two-speed throttle circuit. When vehicle engine is disabled, the auxiliary let down power can be activated by the two-speed throttle switch.</p> <p>NOTE: *Do not operate longer than 30 seconds. Continuous operation will drain battery and/or overheat pump motor.</p>			



OPERATOR CONTROLS AND DESCRIPTIONS

Aerial Device functions may be controlled from either the upper controls at the platform or the lower controls station. The platform controls are used, in normal operation, by the operator to control the Aerial Device. The lower controls are used for inspection, maintenance, and in emergency situations. The Control Selector at the lower controls determines which control station is operable. Only one is operable at any time.

The upper controls may be a single stick control and/or individual levers. The single stick control has one lever that controls all boom functions. The single stick has an enable lever that must be squeezed to allow operation of the boom functions. Center the single stick in the neutral position before depressing the enable lever. Always return the single stick to the centered or neutral position before releasing the enable lever. If the enable lever is depressed while the single stick is not in neutral the function will begin moving suddenly. If the enable lever is released before the single stick is returned to neutral the movement will be unpredictable. The individual levers control each movement separately. The enable lever and the tool control are either on or off. The actual controls on a machine will depend on the options it is equipped with.

Controls provide proportional metering of the function, meaning the distance the control lever is moved determines the speed. The farther the lever is moved from the neutral or center position, the faster the function will operate.

While learning to operate the Aerial Device, do not operate functions at full speed. First, operate each function separately. Then operate two or more functions together. Learn to move the platform in an arc to any desired position within reach of the platform. Operate the functions with smooth, gradual, starts and stops. Use full speed when in clear areas with no obstructions and slow speeds when approaching objects, the ground or truck. Smooth operation will get you to your work area quicker and more comfortably, with less wear and tear on the equipment. Anticipate the time it takes to stop, and begin slowing down beforehand, to stop without overshooting.

Single stick controls are high resistance controls and require periodic test and inspection. The high resistance controls are not rated and are not part of the insulating system that enables the aerial device to have an insulating rating.



The high resistance single stick control does not provide protection in the event of electrical contact and is not a substitute for maintaining minimum approach distance, cover up, rubber gloves, and other personal protective equipment.

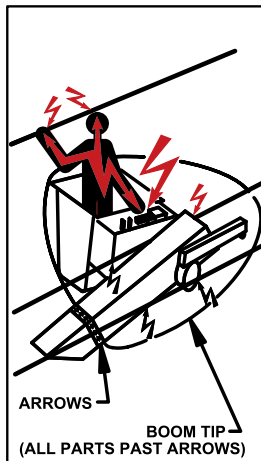

! DANGER

ELECTROCUTION HAZARD

CONTROLS ARE NOT INSULATED OR ISOLATED

All metal at boom tip is electrically connected.
Operator contact with ANY, live or grounded, line or object while operator touches **CONTROLS** or **BOOM TIP COMPONENTS** and boom tip contacts any other line or object can result in

DEATH OR SERIOUS INJURY

Comply with OSHA, ANSI, & NESC requirements

- Maintain proper **CLEARANCE** to all lines and objects
- Wear Personal Protective Equipment: Fall protection; Eye protection; Insulating: gloves, sleeves, and hard hat; & Special clothing
- Cover all lines with insulated line hose or insulating blankets
- **DO NOT** Depend on machine covers for insulation
Plastic or fiberglass covers offer limited electrical insulation.
Covers are **NOT** tested, certified, or maintained as insulating.

463602A



Only the platform operator controls the Aerial Device during normal operation. Never operate the Aerial Device from the ground control with someone in the platform, except in an emergency situation.

LIFT LOCK HANDLES

If a control lever at the upper controls operates a boom function, other than in the single stick, the control will have a lift lock handle.

A spring-loaded lever on each boom function lever locks the levers in a neutral position and prevents accidental actuation. A control lever placard indicates the direction to move the control lever to activate a specific boom movement. To activate a boom movement the handle must be pulled "up" and held, so the control lever can operate the desired boom function. When the handle is released the spring pulls the handle "down" to a neutral position and locks the control lever in that position.

UPPER CONTROLS

SINGLE STICK

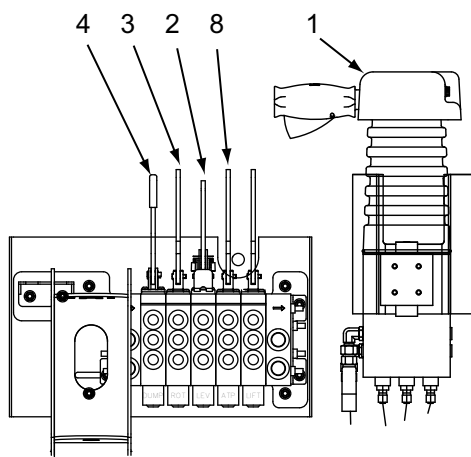

END MOUNT

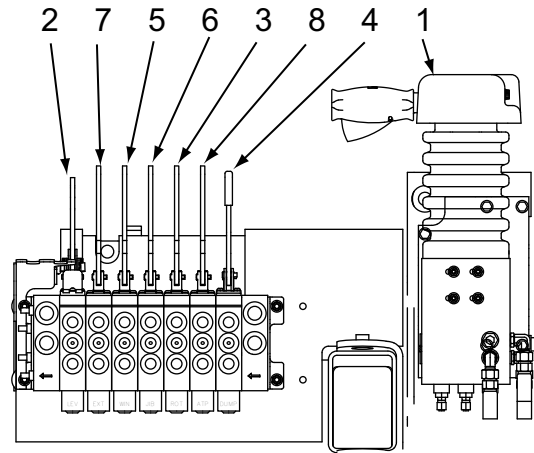

SIDE MOUNT

ITEM	CONTROL	DESCRIPTION
1.	Single Stick	Controls upper boom, lower boom, and rotation.
2.	Platform Leveling	Allows the platform to be hydraulically tilted to level the platform. Utilized for emergency removal and platform clean-out.
3.	Platform Rotation (Optional)	Allows the platform to rotate toward the end of the boom tip.
4.	Stop	Diverts the oil to the tank to stop all operation of platform controls.
5.	Winch (Optional)	Used for operating the winch during material handling operations.
6.	Jib Rotation (Optional)	Allows the jib to be positioned at different angles.
7.	Jib Extension (Optional)	Allows the jib to be hydraulically extended.
8.	Hydraulic Tools (Optional)	Controls oil flow to hydraulic tools.
9.	Two-Speed Throttle	Two-speed throttle provides two engine speeds, low and high, with engine running. Low speed is engine idle.
	Auxiliary Let Down Power (Optional)	Auxiliary let down power provides hydraulic power to lower and stow the Aerial Device in the event of a prime power source failure.
10.	Engine Stop/Start (Optional)	Allows the operator to stop and start the engine from the platform.



- 

The decals are an integral part of this Aerial Device. If the decals are illegible, they must be replaced.
- 

Always operate controls slowly and deliberately for smooth movements. Rough handling is never excusable and may cause damage to the Aerial Device and endanger the operator.

SINGLE STICK OPERATION

The control location shown is generic. The actual location will vary depending on purchasers requirements and options. Some of the following control functions may not be included in the controls for this Aerial Device. Refer to the control decals on unit for proper operation.

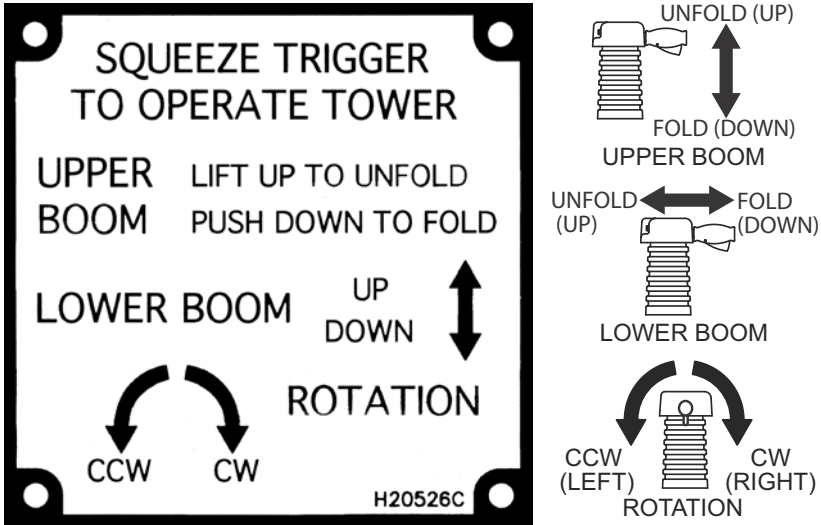

SINGLE STICK CONTROL LABEL

- 



Be sure the control handle is in the centered neutral position before depressing enabling lever. Return the control handle to centered neutral position before releasing the enabling lever. Failure to observe these rules will cause sudden and unexpected movement of the platform. Serious injury or death could result when working in confined spaces or near electrical power lines.
- 



The Aerial Device upper control station has metallic parts, which are necessary to provide the structural support for the various components. These metallic parts are interconnected. The main shaft that supports the platform and controls must also support other load carrying options that can be added to the boom tip.

The fiberglass upper and lower boom, in a well maintained condition, provides electrical insulation between the boom tip and the truck as a potential to ground. This fiberglass will not protect the operator in the platform if any portion of the boom tip, including options, is brought into contact with an energized or non-energized conductor and the operator is in contact with a different potential, such as, a grounded non-energized conductor. This type of contact can energize or ground the controls because as stated before, all components of the boom tip are interconnected. The fiberglass will not provide protection for the operator in phase to phase contact or a phase to ground contact, nor will it protect the vehicle from becoming energized if the steel boom section below the lower boom insert, if so equipped, is brought into contact with an energized conductor.

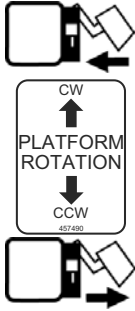
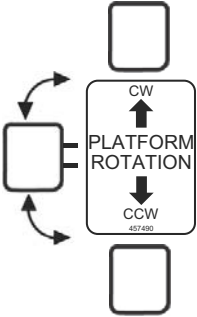
1.	Upper Boom		<p>Squeeze the trigger and lift lever up to “UNFOLD” upper boom.</p> <p>Squeeze the trigger and push lever down to “FOLD” upper boom.</p>
	Lower Boom		<p>Squeeze the trigger and push lever forward to unfold the lower boom “UP”.</p> <p>Squeeze trigger and pull lever back to fold the lower boom “DOWN”.</p>
	Boom Rotation		<p>Squeeze the trigger and twist lever right to rotate booms clockwise “CW”.</p> <p>Squeeze the trigger and twist lever left to rotate booms counterclockwise “CCW”.</p>
2.	Platform Leveling (Optional)		<p>Raise lever by pulling upward to unlock.</p> <p>Push to rotate platform in a clockwise “CW” direction.</p> <p>Raise lever by pulling upward to unlock.</p> <p>Pull to rotate platform in a counterclockwise “CCW” direction.</p>

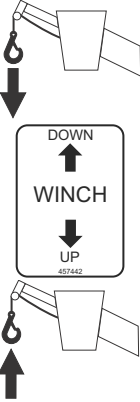
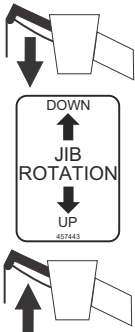

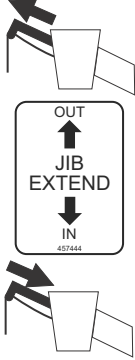
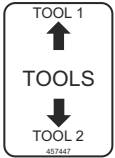
<p>3.</p>	<p>Platform Rotation (Optional)</p>		<p>Push to rotate clockwise "CW" to end position.</p> <p>Pull to rotate counterclockwise "CCW" to stowed position.</p> <p>NOTE: Directions are for side mount platform.</p>
			<p>Push to rotate clockwise "CW".</p> <p>Pull to rotate counterclockwise "CCW".</p> <p>NOTE: Directions are for end mount platform.</p>
<p>4.</p>	<p>Stop</p>		<p>Push to stop all operations at the platform controls. This diverts all oil to the tank.</p> <p>Pull to resume operation.</p>
<p>5.</p>	<p>Winch (Optional)</p>		<p>Push to lower load "DOWN" or pay-out winch line.</p> <p>Pull to raise load or wind winch line "UP".</p>
<p>6.</p>	<p>Jib Rotation (Optional)</p>		<p>Push to lower jib boom "DOWN".</p> <p>Pull to raise jib boom "UP".</p>

7.	Jib Extension (Optional)		<p>Push to extend jib boom "OUT".</p> <p>! Always have one pin installed to prevent jib movement.</p> <p>Pull to retract jib boom "IN".</p>
8.	Hydraulic Tools (Optional)		<p>Push to select tool circuit number 1.</p> <p>Turn tool "OFF" before operating other functions.</p> <p>Pull to select tool circuit number 2, if equipped.</p>
9.	Two-Speed Throttle *Auxiliary Let Down Power (Optional)		<p>With engine running, the throttle is activated.</p> <p>Push and release to increase engine RPM.</p> <p>Push and release to return to engine idle.</p> <p>With engine "OFF", the auxiliary let down power is activated.</p> <p>Push and hold to turn on auxiliary let down power.</p> <p>Release to shut off auxiliary let down power.</p>
<p>NOTE: *Can be included with two-speed throttle circuit. When vehicle engine is disabled, the auxiliary let down power can be activated by the two-speed throttle switch.</p> <p>NOTE: *Do not operate longer than 30 seconds. Continuous operation will drain battery and/or overheat pump motor.</p>			
10.	Engine Stop/Start (Optional)		<p>Push and hold to start engine. Release when engine starts.</p> <p>Push and release to stop engine.</p> <p>! Can also be used to stop the Aerial Device in an emergency.</p>



LOWER CONTROLS

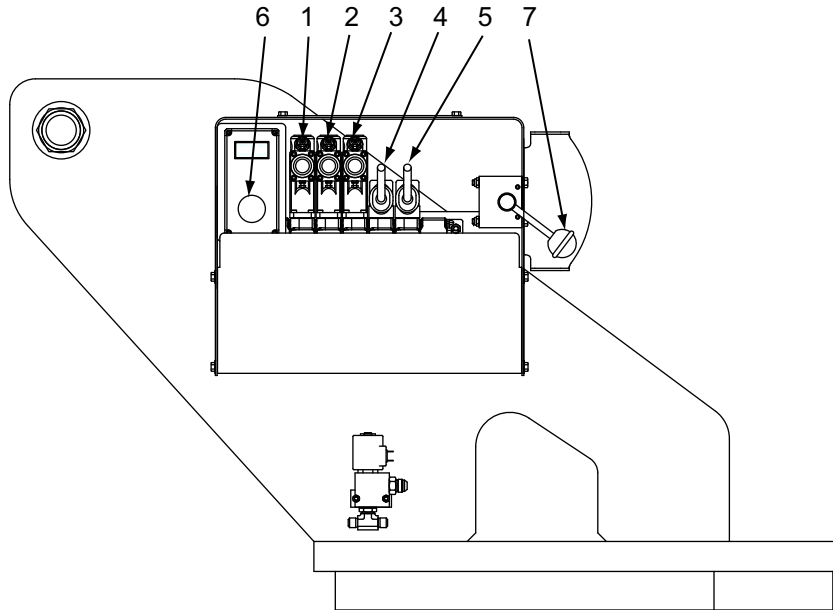

ITEM	CONTROL	DESCRIPTION
1.	Rotation	Controls rotation of booms.
2.	Upper Boom	Controls articulation of upper boom.
3.	Lower Boom	Controls lower boom articulation, upper maintains same angle to truck.
4.	Platform Leveling	Allows the platform to be hydraulically tilted to level the platform. Utilized for emergency removal and platform clean out.
5.	Winch	Used for operating the winch during material handling operations.
6.	Palm Switch	Part of the interlock system. Switch must be depressed and held in order for lower hydraulic controls to be operational.
7.	Top Control and Option Shut Off	Controls oil flow to the option valve and hydraulic tool at the platform. In the "OFF" position no oil is available at the platform valve. Must be in the "ON" position to operate the jib, winch, platform rotate and hydraulic tools at the platform location.



NOTE: Lower boom, upper boom, and rotation sequence may vary. Refer to decal on Aerial Device.

- The decals are an integral part of this Aerial Device. If the decals are illegible, they must be replaced.
- Always operate controls slowly and deliberately for smooth movements. Rough handling is never excusable and may cause damage to the Aerial Device and endanger the operator
- Use the Top Control and Option Shut Off to override upper boom controls with the lower controls if needed. It will stop all oil flow to the boom tip.

TOP CONTROL AND OPTION SHUT OFF

The Top Control and Option Shut Off is used to stop operation of the upper controls. It will stop all oil flow to the boom tip in case of an oil leak. It is also used to override the upper controls in case of an emergency. The upper controls are not operable when the Top Control and Option Shut Off is in the "OFF" position. The lower controls will operate with the shut off in either the "OFF" or "ON" position.

	<p>Use the Top Control and Option Shut Off to override the upper controls. The "off" position stops oil flow to the upper controls and options at the boom tip.</p>
---	---

LOWER CONTROL OPERATION

The control location shown is generic. The actual location will vary depending on the purchaser requirements and options. Some of the following control functions may not be included in the controls for this Aerial Device. Refer to the control decals on unit for proper operation.

The control levers are self-centering, spring-loaded, and return to the neutral position when released.

The hydraulic platform tilt (optional) allows the platform to be tilted for cleaning out the platform and for personnel rescue. Lower controls must be selected for this option to be functional and must never be operated with personnel in the platform except in the case of an emergency.

CONTROL VALVE OPERATION				
LEFT ↑	UP ↑	UP ↑	CCW ↑	UP ↑
TURNTABLE	UPPER BOOM	LOWER BOOM	PLATFORM LEVELING	WINCH
↓ RIGHT	↓ DOWN	↓ DOWN	↓ CW	↓ DOWN

	<p>Keep the truck bed area free of obstructions to avoid interference with the lower controls and personnel who may have to operate the lower controls in an emergency.</p>
---	---

	<p>Do not operate controls while standing on the ground or other structure with booms elevated from stored position. Operating the machine while standing on the ground or other structure could result in electrocution.</p>
---	---

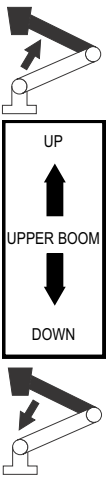
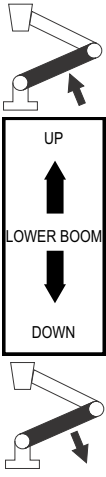

<p>1.</p>	<p>Turntable "Boom Rotation"</p>		<p>Pull lever up to rotate "LEFT" or clockwise (CW).</p> <p>Push lever down to rotate "RIGHT" or counterclockwise (CCW).</p>
<p>2.</p>	<p>Upper Boom</p>		<p>Pull lever up to unfold upper boom "UP".</p> <p>Push lever down to fold upper boom "DOWN".</p>
<p>3.</p>	<p>Lower Boom</p>		<p>Pull lever up to fold lower boom "UP".</p> <p>Push lever down to unfold lower boom "DOWN".</p> <p>As lower boom is articulated the upper boom will maintain the same angle to the truck.</p>

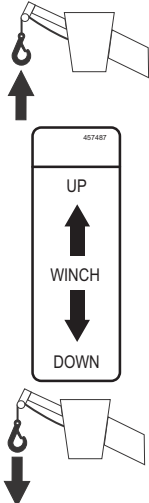
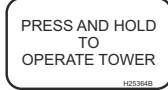
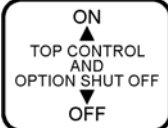
4.	Platform Leveling		<p>Pull lever up to tilt platform counterclockwise "CCW".</p> <p>⚠ Do not operate when personnel are in the platform.</p> <p>Push lever down to level platform clockwise "CW".</p>
5.	Winch		<p>Pull up to raise load or wind up winch line "UP".</p> <p>Push down to lower load or pay out winch line "DOWN".</p>
6.	Palm Switch		<p>Depress and hold switch to operate lower hydraulic controls.</p>
7.	Top Control and Option Shut-Off		<p>Pull up to turn "ON".</p> <p>Push down to turn "OFF".</p> <p>Must be in the "ON" position to operate the jib, winch, platform rotate and hydraulic tools at the platform location.</p>



ACCESSORIES

DEMAND THROTTLE

A demand throttle will increase the engine RPM automatically when a control is actuated. This signals the engine speed to increase therefore the pump output increases. The throttle activation used, electric or hydraulic, will depend on vehicle engine.

ENGINE STOP/START CONTROL (OPTIONAL)

The engine stop/start system allows the truck engine to be stopped and restarted from remote locations. Controls may be located in the cab, at the outrigger control location, at the pedestal or lower controls, or in the platform.

Before attempting to start the engine, make sure the transmission is in neutral, the parking brake applied, and the wheels are chocked.

To start the engine make sure the vehicle key is in the run position and the master switch in the cab is "ON". Push the control labeled "ENGINE" and hold until the engine starts, then release.

The engine will crank as long as the switch is held in the "START" mode. If it fails to start, release and let the starter cool down. The control toggles between start and stop mode, so it is necessary to push and release, then push again to crank the engine if the engine fails to start.

To stop the engine push the switch and then release. Refer to Emergency Operation for further information on the use of this control in an emergency.

TWO-SPEED THROTTLE CONTROL (OPTIONAL)

The two-speed throttle control allows the engine speed to be increased to a high idle position or reduced to the normal idle speed from remote locations. This gives the operator a choice of an efficient, economical engine idle speed with slower boom movement or a faster engine speed with faster boom movements when required. Controls may be located at the outrigger control location, at the pedestal or lower controls, or in the platform. The control will alternate the engine speed between the high and standard idle speeds.

- To increase engine speed, push the switch or air plunger and release.
- To decrease engine speed to an idle, push the switch or air plunger and release.

NOTE: The two-speed throttle is not required when the Aerial Device is ordered if the Aerial Device is equipped with a "demand throttle" which increases engine speed automatically when a control is activated.

AUXILIARY LET DOWN POWER CONTROL (OPTIONAL)

If the power source for the Aerial Device fails, the auxiliary let down power control activates power to stow the Aerial Device if the vehicle electrical system and the hydraulic system is operable. The auxiliary let down power control is combined with the two-speed throttle control. If the engine is not running, the auxiliary let down power is turned on and off by pressing and holding or releasing the two-speed throttle push button. If Aerial Device is not equipped with the two-speed throttle, the control only operates the auxiliary let down power.

NOTE: The auxiliary let down power system should not be operated longer than 30 seconds continuously. Continuous use will drain the battery and damage (overheat) the auxiliary pump motor.

HYDRAULIC TOOLS (OPTIONAL)

Hydraulic tool circuits are used to attach hydraulic powered hand tools to the hydraulic system of the Aerial Device. Quick-disconnect couplings are used to attach hydraulic tools. There may be one or two sets of tool couplers. Only one set of tools can be used at a time.

The tool circuit is for open center hydraulic tools only. Use of closed center hydraulic tools will create a heat problem. Operate tools at low engine speed if equipped with two-speed throttle.

CONNECTING TOOLS

- Clean off couplers before making connections.
- Ensure the tool is off, center position, then connect the tool's return hose to the return coupling and the pressure hose to the pressure coupling.
- To remove tools, turn tool off, center position, then disconnect the pressure coupler first then the return coupler.
- Place dust covers on couplers to keep clean when not in use.

	Only use hoses marked "non-conductive" on tools. The use of tools with hoses that can conduct electricity may cause serious personal injury or death in the event that such hoses come near or in contact with energized power lines.
---	---

USE OF TOOLS

- When tools are not required store them in the truck storage compartments. This will prevent damage to the tool and eliminate the chance of the tool falling.
- Remove tools from the platform when storing Aerial Device for transport.
- Turn tool off when not using tool.
- Do not operate hydraulic hand tools continuously. Continuous operation will cause overheating of the Aerial Device's hydraulic system.
- Turn tool circuit off when moving boom or platform.
- Use only orange, non-conductive hoses, on hydraulic tools.
- Be aware of where the tool hoses are to prevent snagging or contact with objects.
- Do not contact any conductor, pole, guy wire, or any objects with tool hoses, tool couplers or tool fittings. Contact can damage tool circuit and cause a leak.

	Contact of tool hose, quick coupler, or hose fittings against conductors can cause an arc that will burn through hose or fitting and result in a fire.
---	--

	Hydraulic oil is flammable.
---	-----------------------------



PLATFORM TILT

Do not allow anyone to tamper with the platform tilt device while occupants are in the platform. Serious personal injury or death could result from platform upsetting.

The platform leveling system permits the platform to be tilted to clean out water and debris. It also allows the platform to be tilted for personnel rescue. The control may be located at the upper controls and lower controls.

To tilt platform the lower boom must be raised fully and the upper boom folded to get close to the ground (operate from lower controls only).

When using the tilt function do not get in the platform. Operate from the upper controls only while standing on the ground alongside the platform or from the lower controls.

TILTING OPERATION

1. Rotate the platform to its stowed position alongside the boom.
2. Move the control selector at the lower controls for the appropriate control.
3. Position the platform to position shown so the platform is close to the ground.
4. Check for obstructions or people before moving the platform.
5. Move the leveling control as shown to dump the platform for the selected boom position from the lower controls of while standing alongside the platform.
6. Return the platform to level position before moving the booms.

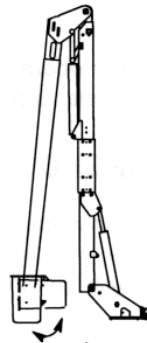

Non-Overcenter Position

NOTE: Return the platform to level before moving the booms to prevent air forming in the leveling system.



Do not tilt platform with personnel in the platform.

PLATFORM LEVELING

The platform leveling is through a master/slave cylinder combination. It can be used for platform clean out when no personnel are in the platform. It can also be used for rescue and removal of an injured operator.

OPERATION

Operate the level control from the lower control station when the platform is empty or is to be dumped for clean out. Position the platform rotation in the stowed alignment along side the boom. Move the booms so the boom tip is in an area clear of obstructions before tilting. When adjusting the level the platform must be raised off the platform rest.

To adjust the platform level from the lower control station:

- Select lower controls.
- Move level control lever slowly in the direction shown on the decal as required to level.

To tilt the platform for clean out or rescue from the lower control station:

- Select the lower controls.
- Position booms so platform is at ground level and platform rotation (if equipped) is in the stowed position.
- Rotate platform to stowed position before tilting.
- Move level control lever slowly in the direction shown on the decal to dump platform.
- Return the platform to normal level position before moving booms.

Operation from Upper control station:

The operation of the platform level from the upper control station must be done slowly and deliberately. Perform all leveling operations while the platform is near the ground or just out of the stowed position. Do not adjust the level position while elevated to a work position.



Do not allow anyone to operate platform tilt while occupants are in platform, except in case of emergency. Serious injury or death could result from platform upsetting.



PLATFORM ROTATOR (OPTIONAL)

The platform rotator allows operator to rotate the platform from the stowed position to the rotated position (end position). When not in use the platform must be placed in the stowed position.

	<p>Prior to platform rotation, observe all obstructions and hazards near the platform's swing path to avoid collisions and contact with lines. Contact with obstruction or lines could cause serious personal injury or death.</p>
--	--

Move the rotator control handle or lever smoothly and gradually for slow platform rotation. Avoid sudden starts or stops when rotating the platform.

When moving the booms, position the platform in stowed position. Rotate platform into desired work position when in work area. Return to stowed position, after work is complete to travel back to ground.

Always store for travel in the stowed position.

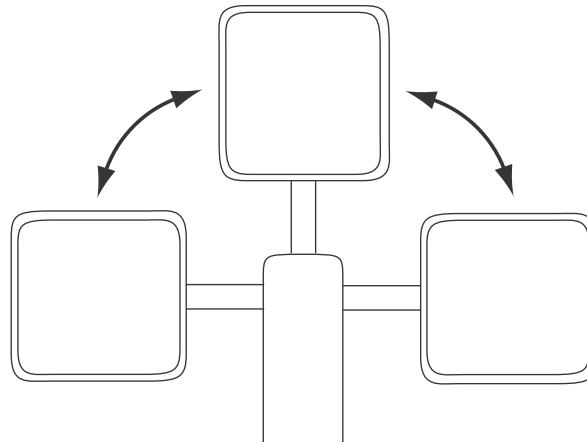

END MOUNT

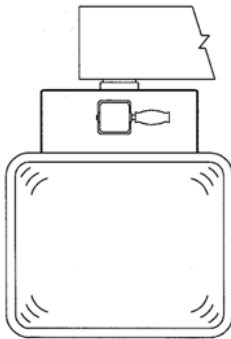

SIDE MOUNT - STOWED POSITION

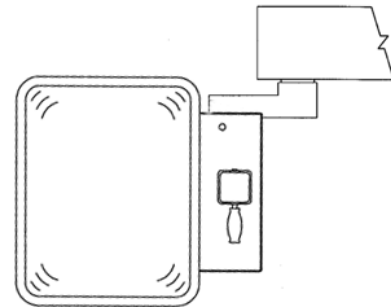

SIDE MOUNT - ROTATED POSITION

	<p>Keep hands away from all moving parts on the rotator assembly when operating or servicing.</p>
--	---

JIB & WINCH OPERATION (OPTIONAL)

When operating the winch under load, always use a smooth movement for lowering or raising loads to avoid shock loads and sudden changes in truck balance. These dynamic shocks can have an effect on the structural members of the Aerial Device. Slow movement should be used on all heavy loads at low engine speed.

Position the Aerial Device so that the boom is properly placed to bring the material to be hoisted to the desired location. This includes adjusting the jib length and angle position.

The jib boom sheave head must not be turned horizontal in respect to the vertical lifting direction it is intended to be used in. Operating in this manner will cause a side load rather than the intended vertical load. The jib and sheave head should not be used in this way. The potential for overload is high, especially to the boom rotation system. The jib and load line should be used for vertical lifting only.

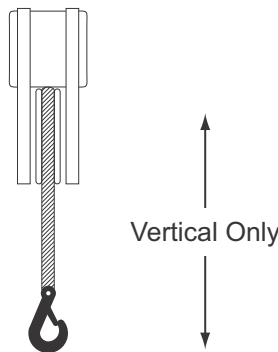

JIB POSITIONING

- | | |
|--|---|
| | Never allow personnel to be under loads being lifted. |
| | Increasing the horizontal distance from the vehicle to the load will affect the stability of the vehicle. Structural damage or instability can result in serious injury or death. |
| | Do not pull, drag, or jerk loads using the winch or rotation controls. This can over load and cause damage to rotation mechanism and other structural components, which can result in serious injury or death. |
| | When lifting loads, the boom will deflect a certain amount and when the load is relieved, the boom will return to the normal position. Always allow extra clearance above and below the boom from any obstacle when lifting a load to allow for this deflection. Serious injury or death can result from such deflections are not considered. |
| | Never exceed the rated load capacity of the Aerial Device. Structural damage or instability can result causing death or serious injury. |
| | Do not pull poles or objects embedded in the ground. It is impossible to know the force applied. Aerial can fail from overload or eject occupants. |



HYDRAULIC JIB EXTENSION (OPTIONAL)

Refer to drawing below.

1. Install pin (1) and remove pin (2).
2. Extend or retract cylinder for desired direction to next hole and insert pin (2).
3. Remove pin (1).
4. Hydraulic extendable jib is now ready for use.
5. If a longer jib reach is required, repeat steps 1 and 2.

NOTE: One pin, either (1) or (2), must always be installed to hold jib in position.

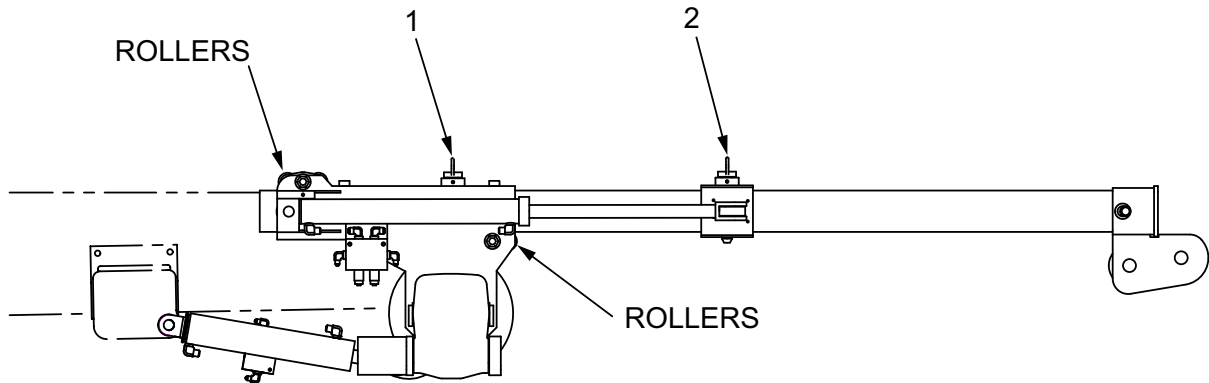

DETERMINING LIFT CAPACITIES

The Aerial Device is equipped with an upper boom angle indicator and load chart on the side of the upper boom near the platform.

The load capacity must be assured for the entire range of the boom motion throughout a lift. Must insure capacity is not exceeded at any point during load movement.

After placing booms and jib in position for lifting the load. Refer to the load chart and find the number below the pointer in line with the load radius. The load radius is defined on the jib capacity chart. The capacity given here is the capacity of the machine for the unit's position.

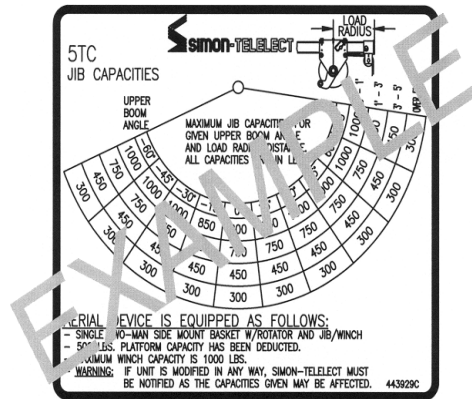



NOTE: Load charts shown are for an example only. Each Aerial Device has its custom made load chart which may have different capacities than shown here.

NOTE: The capacities given on the unit load chart are based on unit setup with the turntable or truck bed being level.

- 

Use only synthetic rope for winch line. Do not use wire rope.
- 

Do not allow winch line to come in contact with guylines, pole, crossarm, ground, or any object that can create a path to ground or energize the winch line.
- 

Dirt, grease, other foreign matter, moisture and humidity will all contaminate the winch line - keep it clean.
- 

Death or serious injury will result if winch line becomes energized.
- 

Inspect rope daily before use.
- 

Use only hooks with a safety latch.



AVOID TRAPPED LOOPS

When winding a line with no load back to the winch drum, lower the boom so that a crewman with gloves can make sure that it is wound level. Trapped loops will damage the winch line or cause a load to drop on the next winch pay out operation.

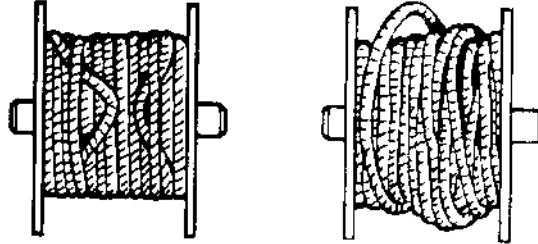

Always keep the winch line wound level and tight on the winch drum.



Do not pull poles or pull any objects embedded in ground. Death or serious injury will result.

CONDUCTOR LIFTING (OPTIONAL)

With the proper attachment, a conductor can be lifted with the Aerial Device. The weight of the conductor must be known and within the lift capacity shown on the load chart. Lifting conductors on an angled structure is not allowed. The jib is not considered insulating, so only non-energized, grounded lines can be lifted, unless a insulating line lifting device is used.

Only inspected and tested insulating attachments with foam filled, hot stick rated glass sections or insulating links on the load line can be used to lift live lines. The attachments must be tested, maintained, and inspected before each use.



Failure to properly insulate conductors from the boom tip will energize the entire boom tip including controls.

PHASE LIFTERS (OPTIONAL)

The single and multiple phase lifters are used for lifting conductors during crossarm or pole changeouts. Single and multiple phase lifters can be used in conjunction with optional mechanical, or hydraulic jib extension.

To operate the phase lifters, position the Aerial Device below the conductors. Pin bracket to jib with manual pin assembly. Place conductors in conductor holders and latch holders. Lift the conductors away from the pole. Lifting live lines requires the Phase Lifter is rated to insulate between the phases and between the phases and the boom tip.



Use only approved hot line tools for lifting energized conductors. Clean and inspect all fiberglass on the conductor lifter before use. Dirty or damaged fiberglass may be conductive.

LOWER BOOM LIFTING ATTACHMENTS

The Aerial Device may be equipped with one of several optional lifting devices on the lower boom.

	<p>When utilizing one of these lifting devices operate the Aerial Device from the lower controls with no one in the personnel platform(s).</p> <p>The upper boom should be raised out of the boom rest approximately twenty degrees (20) such that platforms will clear platform rests. Do not raise upper boom more than forty-five degrees (45).</p> <p>Refer to load charts located at lower control station to determine load that may be lifted.</p>
--	---

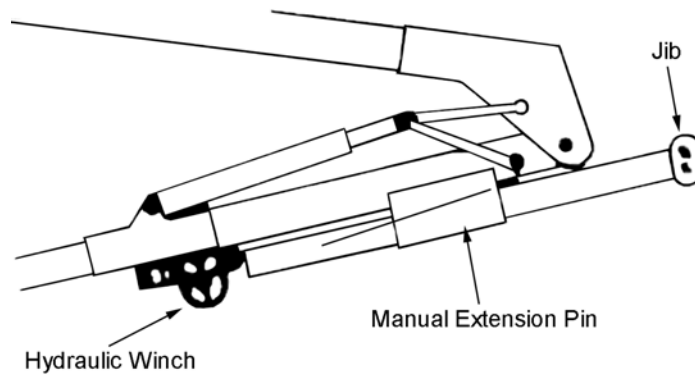

- Hydraulic winch with manual or hydraulic extending jib.
- A control handle is provided at the lower control station for winch up/down operation. The jib may be positioned at different extensions by removing the manual pin, positioning the jib at the desired extension and then replacing the pin.

	<p>Never exceed the rated load capacity of the Aerial Device. Structural damage or instability can result causing death or serious injury.</p>
--	--

	<p>Increasing the horizontal distance from the vehicle to the load will affect the stability of the vehicle. Be careful when lifting and lowering a load with the boom.</p>
--	---

	<p>The platform shall not be used for material handling.</p>
--	--







	<p>Do not open upper boom more than 45 degrees from lower boom.</p>
--	---



BOOM LIFTING EYE MATERIAL HANDLING (OPTIONAL)

A lifting eye may be provided to be used for limited material handling. For maximum lifting capacity, refer to the load chart installed on the Aerial Device.

- Always extend the outriggers (if equipped).
- Boom movements should be smooth to avoid swinging the load.
- Operate only from the lower control station with no one in platform.
- Do not exceed the load limits stated on the decal beside the lifting eye. Deduct any weight that is in or on platform.
- To prevent damage to the Aerial Device, avoid dragging the loads with the lifting eye. This would subject the Aerial Device to damaging side loads.
- When lifting loads, position the boom directly over the load before lifting.
- Upper boom can be open a maximum of 30 degrees.
- Be aware of platform location. Raise boom so platform clears the body and other objects.
- The platform shall not be used for material handling.

	Never exceed the rated load capacity of the Aerial Device. Structural damage or instability can result causing death or serious injury.
	When the vehicle is not level, extreme caution must be used when rotating loads to the low side because the vehicle's stability will be affected.
	Increasing the horizontal distance from the vehicle to the load will affect the stability of the vehicle. Be careful when lifting and lowering a load with the boom.
	Any hooks used in conjunction with the lifting eye must be equipped with a safety latch.
	No personnel allowed inside the platform when using the boom lifting eye. Serious personal injury or death could result.
	Be sure load line is capable of lifting the load and inspect before use. Personal injury or death could result if load line breaks when lifting the load.
	Do not open upper boom more than 30 degrees from lower boom.

LIFTING EYE CAPACITY
1000 LBS.
UPPER BOOM OPEN
30° MAXIMUM
NO LOAD IN PLATFORM

439044

PERSONNEL AND TRAINING

All personnel assigned to an Aerial Device shall be given an opportunity to become familiar with the operation of the equipment before they operate it on a job. The operator and all other personnel should be familiar with the operating procedures. The operator and personnel shall perform training operations until they attain a safe degree of proficiency.

NOTE: Refer to the load chart for rated capacities, boom angles and load radius.

NOTE: Do not exceed load chart capacities.

! DANGER

FAILURE TO OBEY THE FOLLOWING WILL RESULT IN DEATH OR SERIOUS INJURY

- For stationary operation, truck must be securely parked, driveline disengaged, and Aerial Device properly stabilized prior to operation.
- To avoid tip-over, outriggers (when so equipped) must be properly extended on a solid level surface.
- Operate all controls slowly for a smooth platform motion and make sure controls are returned to neutral after desired operation.
- Crew must use proper personal and other protective equipment.
- Never load beyond rated capacity.
- Never operate Aerial Device with personnel under boom or load.
- Never move the truck until the booms and outriggers are in a properly stowed position and secured.
- Refer to the operator's manual for complete instructions. If missing, replace manual.

419262

! DANGER

AN UNTRAINED OPERATOR SUBJECTS HIMSELF AND OTHERS TO DEATH OR SERIOUS INJURY

YOU MUST NOT OPERATE THIS MACHINE UNLESS

- You have been trained in the safe operation of this machine.
- You have read, understand and follow the safety and operating recommendations contained in the machine manufacture's manuals, safety signs attached to equipment, your employer's work rules and applicable government regulations.
- You are sure the machine is operating properly and has been inspected and maintained in accordance with manufacturer's manuals.
- You are sure that all safety signs, guards and other safety features are in place and in proper condition.

419267

Learn the operators inspection and field maintenance requirements. Many times simple maintenance procedures can prevent expensive breakdowns. A brief preliminary check of oil levels, operating conditions of the Aerial Device, and visual inspection of pins, fasteners, and the hydraulic system should be made daily before the unit is put into service.

! If service is indicated, do not delay. Malfunction of one component can cause serious injury to the operator or to others if not corrected immediately.

The operator should also know the brand and grade of oil used in the hydraulic system and where more can be obtained if additional oil is needed.

It takes a desire to learn and a pride of accomplishment on the part of the operator to achieve the proficiency and technique of operation necessary to get the most out of this equipment. The equipment will make the job easier and more enjoyable if a high degree of proficiency is attained.

! The ground crew must be trained to operate the Aerial Device in case of emergency.

A WELL TRAINED CREW IS A PRODUCTIVE CREW!



PRE-OPERATION

DAILY PRE-OPERATION CHECKS

Before operating this Aerial Device, check the following:

1. Perform the frequent and periodic inspections and lubrications as outlined in the maintenance section of this manual.
2. Loose objects; store properly.
3. Under the vehicle for pools of liquid.

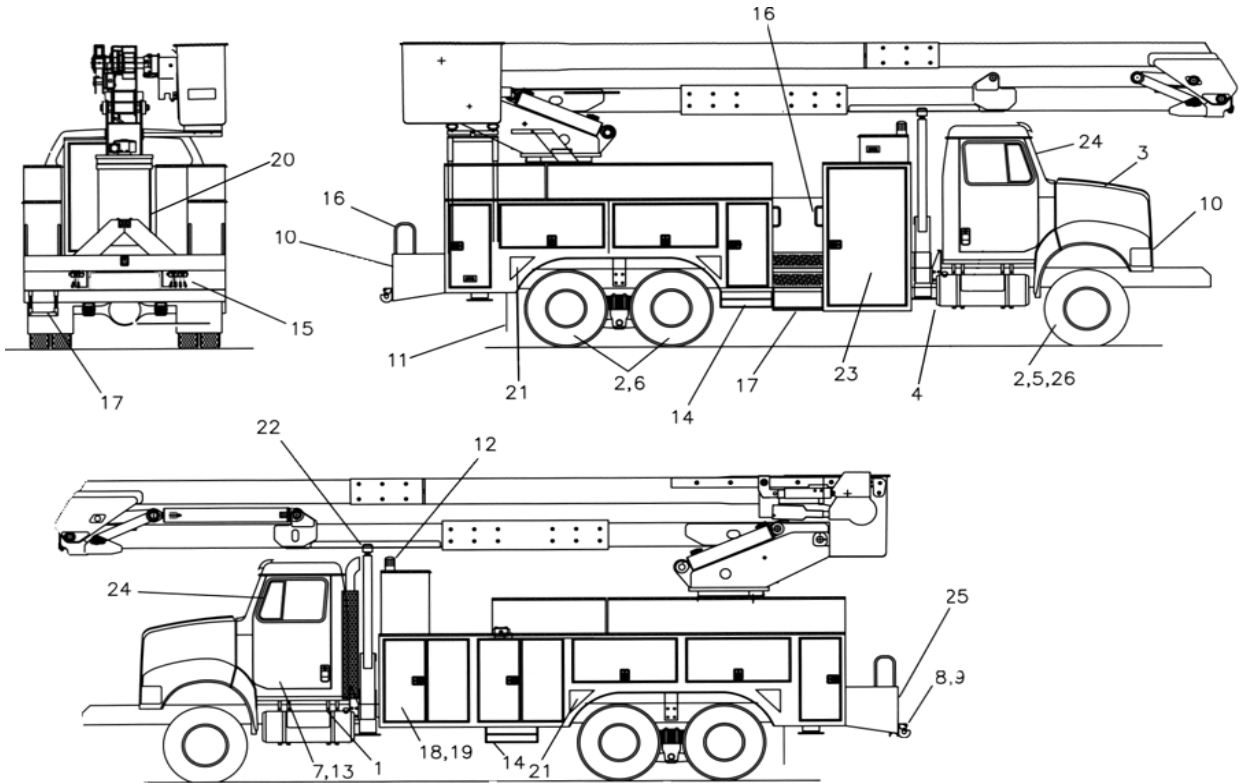

VEHICLE AND BODY CHECKS

ITEM	DESCRIPTION	ITEM	DESCRIPTION
1	Fuel Reservoir	14	Outrigger Pads
2	Tires and Wheels	15	Outrigger and Tool Controls
3	Engine, Radiator, and Cooling System	16	Body Grab Handles
4	Battery	17	Body Access Steps
5	Steering Mechanism	18	Fire Extinguisher
6	Brakes	19	Grounding or Barricade Kit
7	Transmission	20	Hydraulic Reservoir
8	Trailer Light Socket	21	Wheel Chocks
9	Trailer Hitch	22	Boom Rest
10	Lighting	23	Personnel Protection Equipment
11	Mud Flaps	24	Mirrors
12	Strobe Lights	25	Backup Alarm
13	PTO Controls	26	Torsion Bars

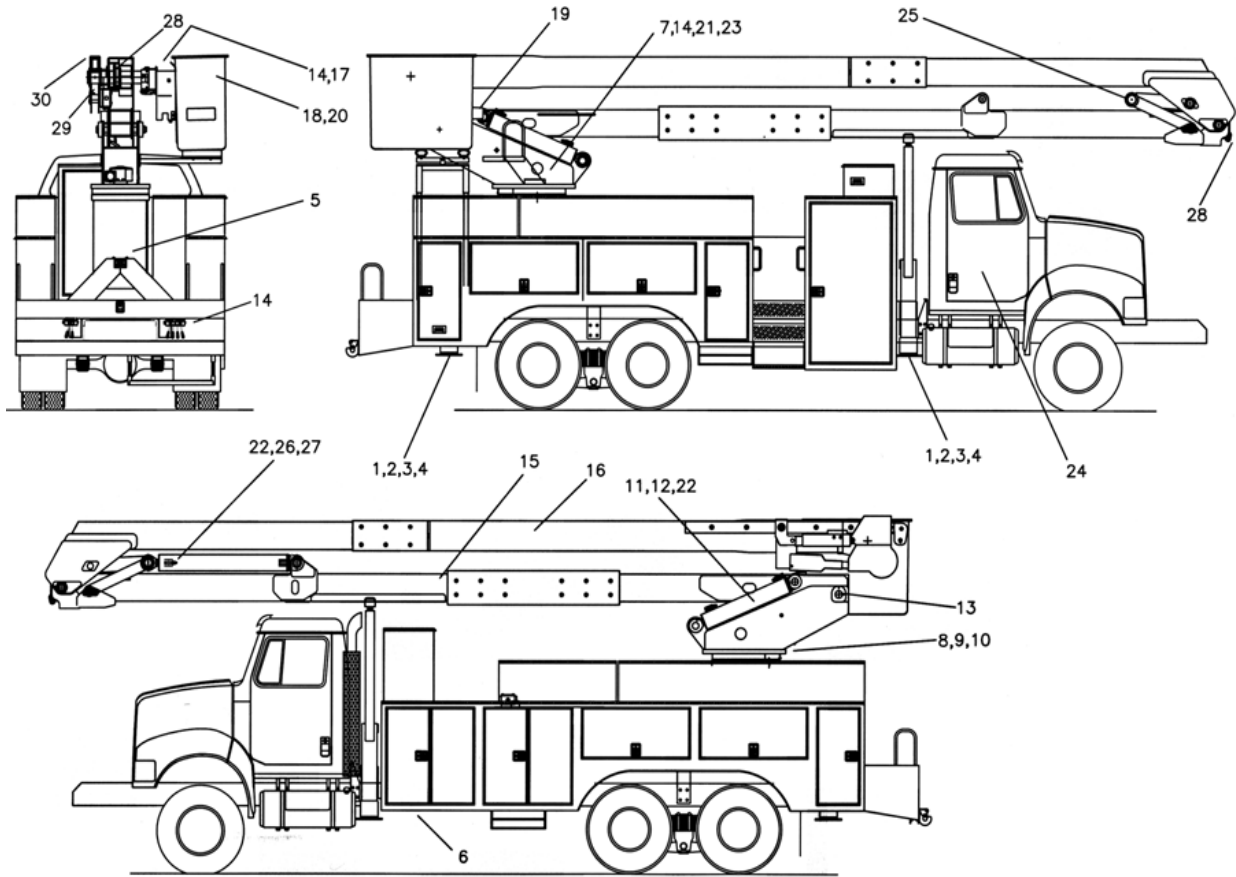

AERIAL DEVICE CHECKS

ITEM	DESCRIPTION	ITEM	DESCRIPTION
1	Outriggers	16	Upper Boom
2	Outrigger Cylinders	17	Upper Controls
3	Outrigger Alarms	18	Platform and Harness
4	Outrigger Mounting	19	Platform Step
5	Return Line Filter	20	Platform Mounting
6	Main or Auxiliary Pump	21	Hydraulic Plumbing
7	Lower Controls	22	Cylinder Holding Valves
8	Rotation Gear Box	23	Electrical Systems
9	Rotation Bearing Bolts	24	Operator's Manual
10	Rotation Bearing	25	Boom Pivot Linkage and Pins
11	Lower Boom Lift Cylinder	26	Upper Boom Cylinder
12	Lower Boom Lift Cylinder Mounting Pins	27	Upper Boom Cylinder Mounting Pins
13	Lower Boom Pivot Installation	28	Leveling Chains and Mechanism
14	Throttle Control	29	Winch Line & Hook
15	Lower Boom	30	Boom Tip Covers & Guards



JOB SITE SURVEY

Before locating the vehicle in position to work, make a complete survey of the job site. During the survey, some of the items to look for include the following:

- Ambient conditions including temperature.
- Consider the slope of the ground. Unit is tested on maximum 5 degree ground slope.
- Determine if the ground is firm enough to support the Aerial Device. If the vehicle must be parked on a slope, always keep the boom on the uphill side, chock the wheels, and work off the rear of the vehicle. If the ground is not firm enough, use pads under the outriggers and crib as needed to distribute the load.
- If unit is not equipped with outriggers, or only has one set of outriggers, evaluate the tire contact area. All tires and axle suspension springs must be equally loaded prior to setting outriggers.
- Look for ditches, drop-offs, holes, debris, and overhead utility and power lines.
- If grass or shrubs will be underneath when the vehicle is setup, cover grass or shrubs with dirt to prevent a fire.
- Determine the vehicle position needed to accomplish the work safely. If it is not safe to proceed use another method or setup.

OPERATING TEMPERATURE RANGE

The ambient operating temperature range of the unit is given on the ID plate. Operation at the extremes of the temperature range requires extra precautions.

Cold weather operation below 10 degrees F (-12 degrees C) requires:

- The hydraulic system must be filled with hydraulic fluid having a pour point suitable for the temperature.
- The hydraulic system must be properly warmed up:
 - Operate the pump at idling speed to allow the oil to warm up gradually. Cold, thick, sluggish oil may not move fast enough and will starve the pump, thus causing severe damage.
 - Circulate the oil through the outrigger system by cycling each outrigger several times before setting up for boom operation.
 - Circulate the oil through the system by cycling each function from the lower controls before operation from the platform.
 - The addition of oil heaters may be required.
- Operate the boom and functions slowly to prevent jerking and shock loads.
- Functions may operate sluggish and not be as responsive, so allow more time and distance when starting and stopping movements.

Hot weather operation above 100 degrees F (38 degrees C) may require intermittent operation to allow the oil to cool or the addition of oil coolers. Do not exceed an oil temperature of 150 degrees F (66 degrees C).

WIND SPEED

Do not operate the Aerial device or Digger Derrick at any wind speed that would create a potential hazard or does not allow safe operation for the work to be performed.

Allow for platform, boom and work-area movement, electrical line sway or sag during windy conditions.

Always account for windy conditions during the worksite inspection or survey.

NOTE: OSHA 1910.269 (x) (5) allows the use of Aerial devices and Digger Derricks up to a wind speed of 30 MPH (48 km/h). The OSHA general duty clause also requires the user to determine if conditions are safe before proceeding with work.

It is both the user's and operator's responsibility to conduct a thorough worksite inspection and determine if the work can be performed and the equipment operated safely in the conditions at the site. It is the responsibility of both the user and operator to also continuously monitor the worksite conditions and if conditions adversely change, to halt all operations until conditions allow for safe operation.

JOB SITE SETUP

Before locating the vehicle in position to work, make a complete survey of the job site. Select a truck position that has a ground slope of less than 5 degrees. This Aerial Device has been tested for stability on a flat firm surface with a maximum slope of 5 degrees. Working on slopes that exceed 5 degrees may result in vehicle tipping over. The truck as built may have torsion bars only, one set of outriggers, or two sets of outriggers or a combination of torsion bars and outriggers. The unit has been tested for stability as equipped. The vehicle can only be used with the stability components as originally installed and tested. If the unit has outriggers they must all be used and set up properly for stability of the unit. If the unit has torsion bars they must be inspected and maintained to provide the force needed for stability.

- Determine if the vehicle is parked on a slope of 5 degrees or less by looking at the level indicator located by the outrigger controls or on the front of the truck body on units without outriggers and also evaluate the axle angle to the truck. The level indicators are only an operator aid, it will tell if the angle at the indicator location is over 5 degrees but will not tell if the ground is less than 5 degrees or how much the frame is twisted. The operator must visually verify the ground condition and that the truck axles uniformly support the truck weight. If the tires are hanging on one axle spring, barely touching the ground, and the other tire spring is up against the rubber stop, the frame angle is different than the axle angle. The axle suspension is not loaded uniformly and may not provide proper stability.
- The unit will be equipped with an inclinometer, shown below. The ball must be in the green area. If the or ball is in the red area, the truck is at an angle greater than 5 degrees and the truck position must be changed before use. Change the position of the truck by repositioning the truck or by cribbing the tires of the truck until it is less than 5 degrees and the suspension on each axle is uniformly loaded. If the truck is parked in a location with less than a 5 degrees slope and the tires equally support the truck and load, proceed to setup the unit.

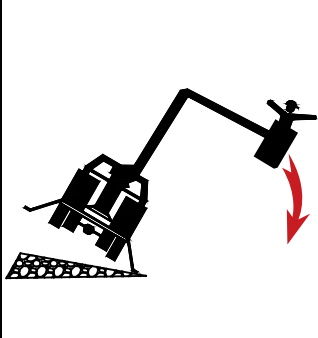

! DANGER

**OVERTURNING HAZARD
DEATH OR SERIOUS INJURY**

May result from overturning machine

- This unit has been tested for stability on a maximum slope of 5 degrees.
- Working on slopes that exceed 5 degrees may result in truck tipping over.
- All tires must remain on the ground.
- Position or park truck so indicator is in the green area.
- Set Outriggers (if equipped) so indicator remains in green area.

458696A

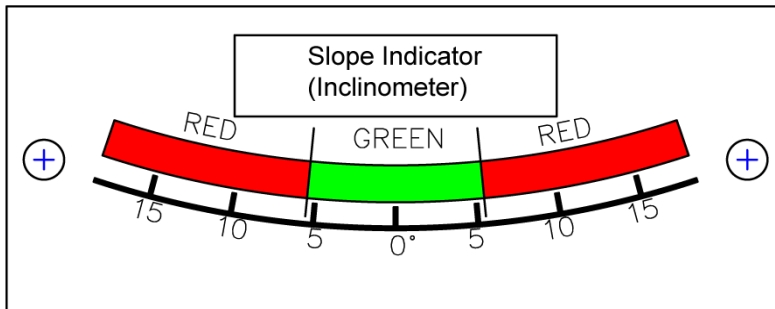

INCLINOMETER LEVEL INDICATOR



Working on slopes that exceed 5 degrees may result in vehicle tipping over. The level indicators are only an operator aid, it will tell if the angle is over 5 degrees at the indicator location but will not tell if the ground is less than 5 degrees or frame twisted. The operator must visually verify the ground condition.



- If unit is not equipped with outriggers, or only has one set of outriggers the tires and suspension on each side of each axle must uniformly support the truck and load because they are part of the stability system when operating the Aerial Device. If one tire and axle spring is not loaded the same as the other, on that axle, it will not be able to provide the stability needed.
 - A tire cannot be in a hole or depression even if the truck is parked and the indicators show less than 5 degree angle.

If unit is equipped with two sets of outriggers, the axles not between the outriggers must equally support the load of the truck so the suspension on each side is equally loaded.



On Aerial Devices with no outriggers or only one set of outriggers the tires and truck suspension are a very important part of the stability system.

- Tires must not be parked in holes or depressions.
- Truck suspension must be equally loaded on each axle to provide support prior to setting outriggers.
- Tire pressures must be correct.



If the unit is equipped with a lower lift, the unit will have more stringent requirements for proper stability. Refer to decals on the vehicle or the supplement at the end of this manual.

Use the following procedure after the vehicle is in position at the work site:

- Turn on warning lights.
- Place vehicle in neutral and set brakes before leaving cab.
- Chock the wheels.
- Position and use signs, warning lights, and barricades in accordance with OSHA, ANSI, state, and company rules and regulations.
- When work is to be performed on or near power lines, ground and/or barricade vehicle according to your company policy. If using a temporary ground connect grounding cable clamped to a static line or neutral, or use drive or screw type ground rod to ground truck according to your company policy. Unroll ground cable fully and spread out so cable does not cross over.
- Engage the power take-off (PTO) following the directions given with the specific PTO installed on the truck.
- Turn master switch on to provide electrical power to electrically powered options.
- Set the outriggers (if equipped).



If the unit is equipped with outriggers, all outriggers must be set properly to provide adequate stability.

SETTING THE OUTRIGGERS

Before lifting or rotating the Aerial Device, all outriggers (if equipped) must be lowered firmly to the ground on a surface that can support the load, and kept there until all work is complete and the Aerial Device is stowed for travel. The stability of the Aerial Device depends on the gross weight of the vehicle, platform and jib load, the slope of the ground in the work area, and whether the ground is firm enough to support the load imposed. The condition of the truck tires, axles, torsion bars, outriggers and outrigger pads or cribbing all contribute to proper stability. These conditions are widely variable, so the operator must exercise good judgment and caution when setting the outriggers before utilization of the Aerial Device.

The method of setting the outriggers will vary depending on the number of outriggers and configuration. If the vehicle is equipped with one set of outriggers, the tires and the spring force of the truck axle work with the outriggers to provide stability. The location of the outriggers relative to the truck axles and the pedestal will determine how much the outriggers can be extended.

When lowering the outriggers:

- Determine if truck is properly parked with brakes applied and wheels chocked.
- Position the outrigger pads and ensure that the surface will support the outrigger force, crib as required.
- Before lowering the outriggers, check the area where the outriggers will extend to ensure no personnel or other objects are in the path. Alert all personnel that the outriggers are being moved and positioned.

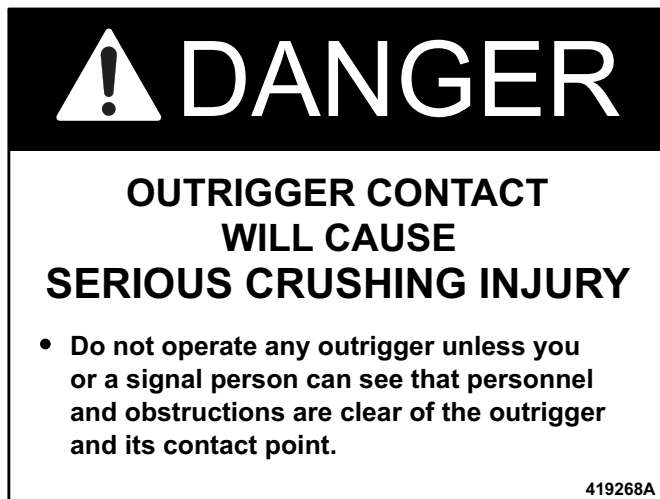

- Units with one set of outriggers behind the rear axles on rear axle mounts, extend the outriggers until the weight of the vehicle is off the springs. Rear tires must remain on the ground. More outrigger extension is allowed the closer the axle is located to the outrigger.
- Units with one set of outriggers between the axles on behind-the-cab mounts, set the outriggers firmly on the ground, but do not raise the weight of the vehicle off the springs. Tires must remain on the ground with the truck suspension providing equal support on each side of each axle.
 - Do not attempt to correct the ground slope with the outriggers; this unloads the low side tires and suspension. The suspension may not provide enough force for stability.
 - After setting the outriggers evaluate the truck position and setup. Determine if the tires are equally supporting the load by looking at the clearance to the fenders, body, or bed and the axle location to the axle stop, (rubber bumper) and overload springs. If one tire is closer to the body and the other tires on the opposite side of the same axle is farther away from the body the unit is not set up properly. The spring deflection on each side must be the same or the overload springs or rubber bumper both in contact with their stops. Tires on the low side must be cribbed to equalize the truck suspension load so it can provide the force needed for stability if not equally loaded as parked.



- Two sets of outriggers: The outriggers are extended to support the weight of the unit. The tires must remain in contact with the ground.
 - The vehicle can be leveled slightly with the outriggers.
 - The axles not located between the outriggers must equally support the load of the truck so the suspension on each side is equally loaded.
 - If the unit is equipped with a lower lift more stringent requirements may be required for proper stability. Refer to decals on the vehicle or manual supplements for proper instructions.



The outrigger moving alarm will sound when the outrigger control is activated. If the alarm does not sound, it must be repaired.

SETTING UP ON A SLOPING SURFACE

If the vehicle must be set up across a slope, the surface can be up to 5 degrees from level but must be firm and flat where tires are located. If one side of the vehicle is low, extend the low side outrigger first and make sure that firm contact is made. If full extension does not make firm contact, the outrigger pad must be blocked up. Always chock the wheels. Keep the boom on the uphill side. If the slope exceeds 5 degrees before setting the outriggers the tires must also be blocked and cribbed so the truck is parked at less than 5 degrees. If the unit has one set of outriggers do not level the truck with the outriggers. On units with one set of outriggers using the outriggers to level the truck does not change the slope, it reduces the truck suspension's ability to support the load and provide stability.

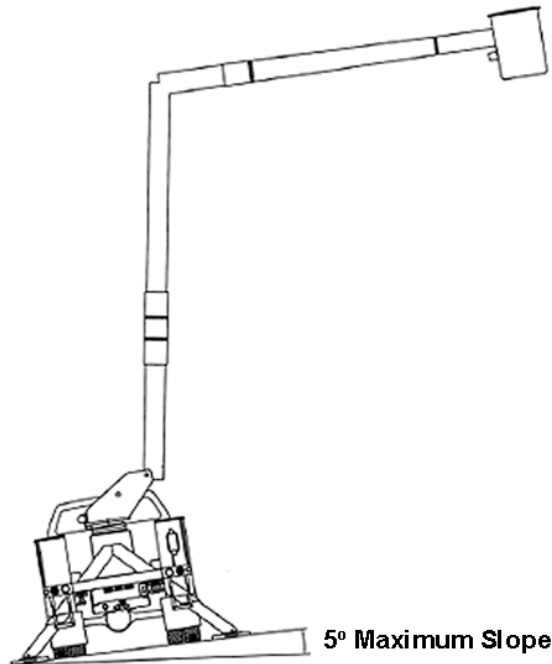

VEHICLE SETUP ACROSS THE SLOPE



Working on slopes that exceed 5 degrees may result in vehicle tipping over.

RMX SERIES

If the vehicle must be set up with the slope, always keep the boom on the uphill side of the vehicle, chock the wheels, and always work off the rear of the vehicle.

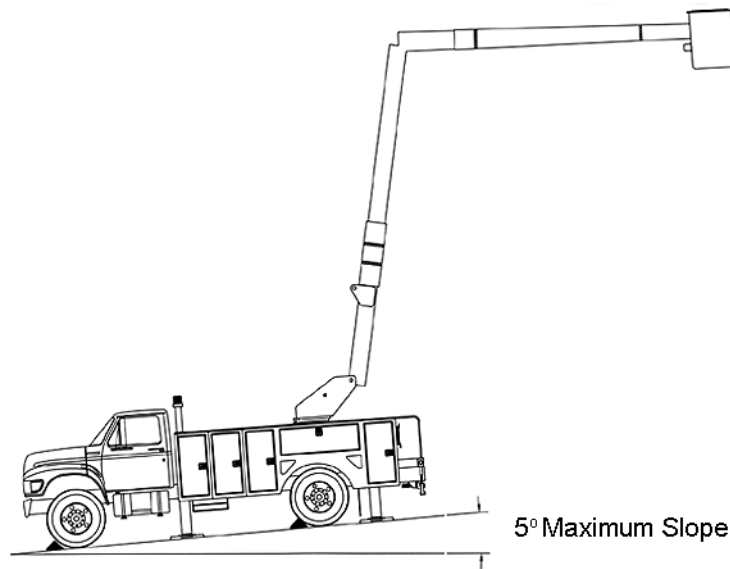

VEHICLE SETUP WITH THE SLOPE

If the vehicle must be set up where an outrigger extends into a ditch or gutter and the full extension does not make firm contact, the outrigger must be blocked or cribbed up. Chock the wheels carefully to prevent motion of the truck. Ensure cribbing (if required) provides stable support. If the vehicle must be set up so an outrigger rests on a curb with the vehicle in the street, the outrigger span will be shortened and stability is reduced. Ensure the curb has sufficient strength to support the load. All of the previous may affect the stability of the vehicle and restrict the load capacity of the vehicle. Proceed with caution under these conditions. If the outrigger support surface is not level with the truck, the bank may need to be cut away or brought up to a level so the outrigger will provide proper support. The ground must be able to support the load of the outrigger without sinking.

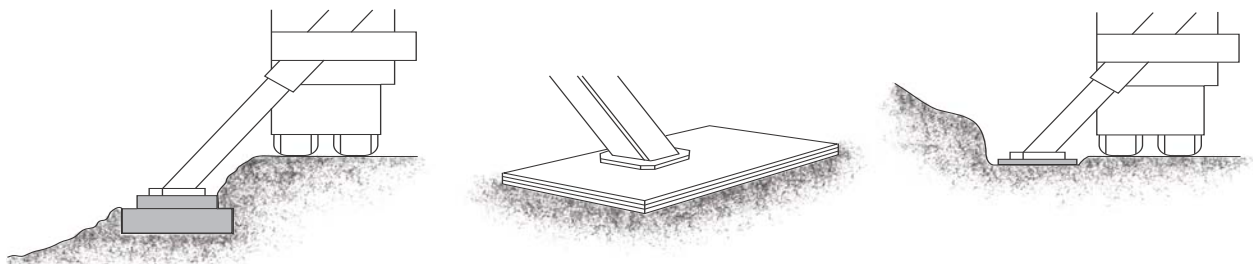

SETTING UP ON A SOFT SURFACE

If the ground is too soft to support the outrigger load or wheel load, the outriggers or tires must be padded or cribbed until the ground will support the load or the unit cannot be used at that location. Make certain the tires and outriggers are centered on the pads and the cribbing provides stable support as the booms are moved.



SETTING UP FOR OPERATION ON SNOW AND ICE

Operation on snow and ice adds an additional problem due to the slippery conditions. Normal traction is greatly reduced. Just as you need to maintain traction to walk and drive, it is required to keep Digger Derricks and Aerial Devices in a stable position. Rotating and moving the booms may cause the truck to jerk and move. If the unit is not set up securely the truck can slide on ice and snow while operating. When planning your work remember that driving in snow causes snow dust to be deposited on all surfaces. The outriggers and outrigger pads will get snow covered and slippery. Also, as you put pressure on snow, the snow packs down and turns to ice. The person setting the unit up for operation has the entire responsibility for a stable position. The person on the site is the only one who can evaluate the conditions and terrain.

Proper set up requires:

- Outriggers do not slide on the outrigger pads during use.
- Outrigger pads do not slide on the ground during use.
- Set the parking brakes.
- Chock wheels as required, to prevent movement down hill. Evaluate chock location to prevent the truck pivoting around one chock.
- Set units with one set of outriggers so all tires are on the ground.
- Evaluate the terrain to determine the most flat and level set up position.
- Set up truck so if the truck does move slightly, the result isn't catastrophic.
- Follow Operators manual for set up instructions. Do not place outriggers on Ice as slippage may occur regardless of solid footing.

To properly set up you may need to:

- Remove snow and ice down to bare ground to prevent sliding and to evaluate the support available. Don't set outriggers on a manhole cover or the edge of a slope or drop off.
- Move as far as required into the street or road so if the truck does move, the tires and outriggers will not slide into the ditch or other hazards.
- Choose a location for the truck that gives the best stability for the work to be done.
- Come back later, to do the work, if the roads are not cleared sufficiently.
- Use traction aids under the tires and outriggers such as sand and gravel or mats.
- Operate the unit smoothly by "feathering" the controls, not jerking the levers.

OUTRIGGER / UNIT CONTROL SELECTOR

The Outrigger/unit Control Selector must be in the "OUTRIGGER" position to raise or lower the outriggers. The lever must be in the "UNIT" position to operate the boom functions. If equipped with hydraulic tools at the outrigger valve they will have priority over other operations. When the tools are "on" the "UNIT" and "OUTRIGGERS" will not get hydraulic oil flow and will not operate.



Do not use, connect, or disconnect the lower hydraulic tool if the booms are in or near energized lines. Death or serious injury may result if the truck becomes energized.

BOOM INTERLOCK

If the completed unit requires outriggers for stability it will be equipped with Boom Interlock. Boom Interlock will prevent boom operation unless the outriggers are extended. The booms will not operate if the outriggers are not extended past a predetermined point. The operator must ensure the outriggers are set properly to provide stability. If the booms do not operate and the Outrigger/Unit Control Selector is selected to "UNIT" then verify the outriggers are properly extended. The operation of the boom interlock does not assure Aerial Device stability. It only serves to remind the operator that the outriggers have not been deployed.



TORSION BARS (OPTIONAL)

Torsion bars may be installed on the rear axle, front axle, or both; alone or in addition to outriggers. If the vehicle has torsion bars, the tires, and suspension are important because they are providing the stability. Check the tire pressure and condition before each use of the vehicle. The tires must be on solid footing, with each tire equally loaded. If not, use pads and cribbing as required, or reposition the vehicle to solid ground. Refer to the level indicators to be sure the vehicle is parked at less than 5 degrees from level. If not, wheels must be cribbed to level the vehicle to less than 5 degrees slope. Ensure the tires are not in a depression. All tires must be equally loaded to provide support. To determine if the tires are equally loaded, check the spring deflection on each side. The deflection must be the same or the overload springs or rubber bumper both in contact with their stops. Also the tire clearance to the body on each side needs to be similar.

STABILITY

The stability of a vehicle equipped with a rotating aerial device depends on the gross weight of the vehicle and load, the slope of the work area, and whether the ground is firm enough to support the weight of the outrigger pads. These conditions are widely variable, so the operator must exercise good judgement and extreme caution to learn just what their particular vehicle can handle.

IMPORTANT: Know the loading capacities of your unit under all conditions of load, terrain, and Aerial Device.

-  Keep loads close to the ground until you determine for sure that the load can be balanced safely at the maximum distance you wish to work.
-  Increasing the distance from the vehicle to the load will affect the stability of the Aerial Device. Keep loads close to the ground until you determine that the load can be balanced safely at the maximum distance you wish to work.
-  This Aerial Device has been tested for stability on a flat firm surface with a maximum slope of 5 degrees. Working on slopes that exceed 5 degrees may result in vehicle tipping over.



OPERATION

BOOM OPERATION

The RMX Series is a non-overcenter material handling Aerial Device. The normal material handling operating range is when the upper boom is below 70 degrees above horizontal and the lower boom is below 90 degrees above horizontal. The lower boom will articulate up to 118 degrees but only to allow ground access to the platform, not for material handling. To articulate the lower boom between 90 and 118 degrees the upper boom must be less than 50 degrees open from the lower boom.

The upper boom will operate up to 75 degrees above horizontal. When the boom reaches 70 degrees above horizontal it slows down for the last 5 degrees of travel. The lower boom will also stop lowering or going in the stowed direction, when the upper boom is at 75 degrees. The lower boom articulation will be disabled when the upper boom gets to 75 degrees above horizontal. When boom movement is stopped by the limit system it will be necessary to lower the upper boom or raise the lower boom slightly to reset the valves and allow operation.

The normal operating range is 0 to +90 degrees for the lower boom and -85 to +70 degrees for the upper boom. Within this range full jib capacity is available and boom movement is unrestricted. When the lower boom gets to 90 degrees it trips a switch that disables upper boom up and lower boom up. If you wish to raise the upper boom at this position, you must back the lower boom off slightly below 90 degrees. This allows the platform to get close to the ground to get in and out of the platform. To get to the ground the lower boom must articulate to 118 degrees. That cannot happen unless the angle between the booms is less than 50 degrees. The operator must be aware of where the boom is during operation and not operate if the lower boom is above 90 degrees, except for ground access. The limit system is an operator aid, do not depend on it but operate only in the non-overcenter range.

All boom movements should be smooth. Avoid jerking by slowly metering the control valves when starting and stopping all motions. Start and stop all boom movements with a low engine speed to make it easier to "feather" the controls for smooth operation. Lift the boom off the rest and elevate it high enough to clear all body obstructions before rotating. RMX Series Aerial Devices are equipped with a standard three port collector block oil distribution center in the mast which permits the continuous rotation of the boom in either direction without stops.



Failure to operate in the non-overcenter range or to lift materials with the lower boom above 90 degrees may cause structural damage or tip over.



Make certain that all personnel are in the clear and that there is sufficient overhead clearance before operating the Aerial Device.

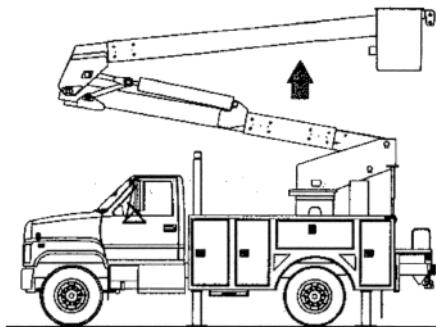

UNSTORE THE BOOM

Before attempting to raise the booms, remove all boom hold down straps. Ensure area overhead is clear and raise upper boom before raising lower boom. Raise booms sufficiently to clear all obstructions before rotating.

AERIAL OPERATION

Before using the Aerial Device, the operator should check through the pre-operational procedure to ensure the vehicle is properly positioned with outriggers (if equipped) firmly in place. Extreme care should always be exercised when lifting personnel.

Before entering the platform, place the outrigger control selector (if equipped) and the lower control selector to the upper controls.

After entering the platform, connect the lanyard to the attachment ring located on the platform bracket. An OSHA Approved Fall Protection System must be used.

The indicated number of lanyards may be attached to the lanyard anchor provided, one or two as indicated by X1 or X2 on decals.

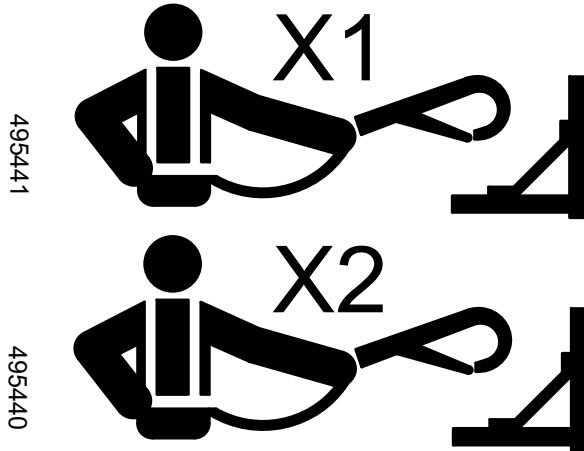

! DANGER

READ CAREFULLY

- OCCUPANTS OF THE BASKETS OF THIS AERIAL DEVICE HAVE ABSOLUTELY NO ELECTRICAL PROTECTION FROM CONTACT BY THE HUMAN BODY WITH TWO ENERGIZED CONDUCTORS OR BETWEEN AN ENERGIZED CONDUCTOR AND A GROUNDED CONDUCTOR.
- It makes no difference if this contact is accidental or deliberate or whether contact is made through metallic parts of the basket, basket support, metal tools or equipment brought into the basket. The insulating components of this aerial device do not offer protection in the event of such contact.
- Proper conductor cover up, insulated sleeves and gloves shall be worn when working near energized lines or equipment.

DEATH OR SERIOUS INJURY WILL RESULT FROM SUCH CONTACT OR INADEQUATE CLEARANCE

414590A

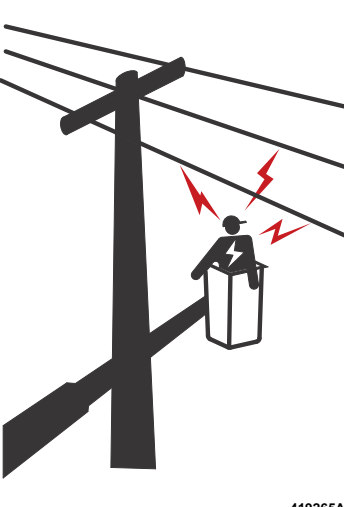

<p>! DANGER</p>	
<p>FALLING FROM PLATFORM WILL RESULT IN DEATH OR SERIOUS INJURY</p> <ul style="list-style-type: none"> • Platform personnel must wear an OSHA approved fall protection system with lanyard attached to anchor provided. • Platform doors, if provided, must be securely latched. 	
<p>419264A</p>	

<p>! DANGER</p>	
<p>ELECTROCUTION HAZARD THIS MACHINE IS NOT INSULATED DEATH OR SERIOUS INJURY</p> <p>Will result from contact with or inadequate clearance to electrical power lines and apparatus</p> <ul style="list-style-type: none"> • Maintain safe clearance from electrical power lines in accordance with applicable government regulations. Allow for boom, platform, electrical line and load line sway. • This machine does not provide protection from contact with or proximity to an electrically charged power line. • Boom and platform must be kept below all electric power lines. • Do not use for work on electric power lines. 	
<p>419265A</p>	

 <p>ARROWS BOOM TIP (ALL PARTS PAST ARROWS)</p>	<p>! DANGER</p>
<p>ELECTROCUTION HAZARD</p> <p>CONTROLS ARE NOT INSULATED OR ISOLATED</p> <p>All metal at boom tip is electrically connected. Operator contact with ANY, live or grounded, line or object while operator touches CONTROLS or BOOM TIP COMPONENTS and boom tip contacts any other line or object can result in</p> <p>DEATH OR SERIOUS INJURY</p> <p>Comply with OSHA, ANSI, & NESC requirements</p> <ul style="list-style-type: none"> • Maintain proper CLEARANCE to all lines and objects • Wear Personal Protective Equipment: Fall protection; Eye protection; Insulating: gloves, sleeves, and hard hat; & Special clothing • Cover all lines with insulated line hose or insulating blankets • DO NOT Depend on machine covers for insulation Plastic or fiberglass covers offer limited electrical insulation. Covers are NOT tested, certified, or maintained as insulating. 	
<p>463602A</p>	

	<p>Do not allow any part of the Aerial Device to come in contact with any electrical conductors, either energized or non-energized.</p>
---	---

USE PROTECTIVE EQUIPMENT SUITABLE FOR THE WORK BEING PERFORMED:

- Wear your rubber gloves and sleeves when working on or near electrical equipment.
- Install hose, covers, and mats on all energized and grounded conductors.
- Wear protective and insulated headgear.
- Use a platform liner.
- Death or serious injury could result from such contact or inadequate clearance.

	Do not move the vehicle with personnel in the platform. This Aerial Device is not designed for this type of operation. All passengers must be seated in vehicle according to manufacturer’s designated positions.
---	---

Study the movements required to reach the work location. Use a feathering technique with control levers to ease the Aerial Device to smooth starts and stops. Use low speeds, when approaching the aerial job site. Use high speed only between ground and job site and job site and ground. Always look in the direction the Aerial Device is traveling to be certain there is clearance for the boom(s), platform, and operator.

Be aware of any obstacles the lower boom may strike if rotated or elevated, and any objects that the booms may come close to as movements are made.

If equipped with engine throttle control, use low engine speed if extended time will be spent at one site.

	Do not leave the platform to build trestles between the platform and another work location.
---	---

	Avoid careless handling of tools and equipment while aloft. Use a tool tray to help prevent dropping items. Keep all ground personnel away from the area directly under the work point unless absolutely necessary, and caution them that it is necessary to be constantly on the alert for possible falling items.
--	---

	Use orange hose marked NON-CONDUCTIVE for tool hoses, at the boom tip, and areas that bridge the insulation gap.
---	--

	Do not let hoses hang where they can catch on or contact energized conductors or grounded conductors on any structure.
---	--

	<p>The Aerial Device upper control station has metallic parts, which are necessary to provide the structural support for the various components. These metallic parts are interconnected. The main shaft that supports the platform and controls must also support other load carrying options that can be added to the boom tip.</p> <p>The fiberglass upper and lower boom, in a well maintained condition, provides electrical insulation between the boom tip and the truck as a potential to ground. This fiberglass will not protect the operator in the platform if any portion of the boom tip, including options, is brought into contact with an energized or non-energized conductor and the operator is in contact with a different potential, such as, a grounded non-energized conductor. This type of contact can energize or ground the controls because as stated before, all components of the boom tip are interconnected. The fiberglass will not provide protection for the operator in phase to phase contact or a phase to ground contact, nor will it protect the vehicle from becoming energized if the steel boom section below the lower boom insert, if so equipped, is brought into contact with an energized conductor.</p>
---	---

	Do not depend on Aerial Device covers for insulation. Plastic or fiberglass covers offer limited electrical insulation. Covers are not tested, certified or maintained as insulating.
---	---



EMERGENCY OPERATION

Emergency operation may be required if an operator is injured or the equipment malfunctions. In any emergency, the first priority is always the safety of the personnel involved. It is always important to remember to follow the standard work practices and the safety regulations that apply. If the Aerial Device is operable, move the platform away from the danger and into the shortest, clear path of descent to get the operator on the ground. If the Aerial Device is inoperable, consider using another Aerial Device to rescue the operator from the platform. If an equipment defect is suspected, do not allow anyone to enter the platform. Instead if the situation allows safe operation from the lower controls, override the upper controls and carefully lower the platform to the ground.

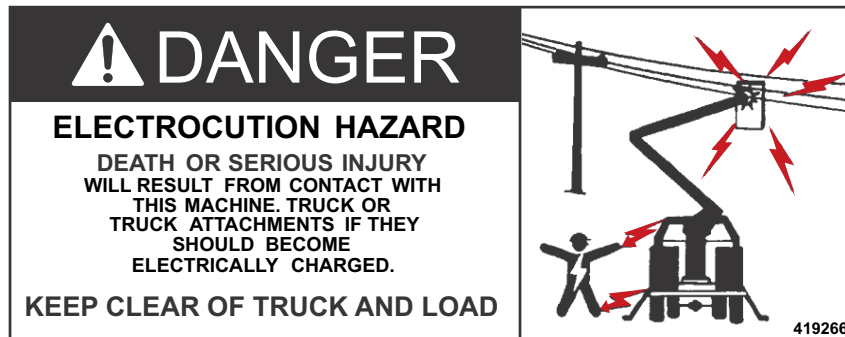

Do not touch the truck or attachments and the ground at the same time. If the truck, including Aerial Device or any attachment connected to the truck, contacts a power line, you will be a path for the current. Death or serious injury will result.

POWER LINE CONTACT ON GROUND

VEHICLE IS TOUCHING A POWER LINE

Take these steps if your vehicle makes contact with a live power line while you are in or on the vehicle:

- Treat any line, as live unless you know for sure it is not.
- Stay inside or on the vehicle until the power is disconnected or turned off.
- Warn others to stay away from the vehicle and any trailers or attachments.
- If you must get away from the vehicle because of fire or other danger:
 - Jump out and away from vehicle.
 - Do not touch the vehicle and ground at the same time.
 - Land with your feet close together.
 - Shuffle away taking very small steps keeping feet together.
 - Do not try to help others out of the vehicle, you could get electrocuted.

STANDING ON GROUND CLOSE TO FALLEN POWER LINE

You must shuffle keeping feet together, do not run. The voltage is highest where contact is made and decreases as you get farther away from the point of contact. The distance will depend on the ground conditions and conductivity of the ground. If you run, your legs will bridge from higher to lower voltage and current will pass through your feet and legs. Keep your feet together and shuffle to go from one voltage gradient to the next gradually. This will decrease the chance of electrocution as you move away from the vehicle or fallen wire.

- Never touch a fallen power line unless you are trained and properly equipped to handle it safely.
- Shuffle away using very small steps keeping feet together; do not run.
- Do not touch anything as you leave the area.
- Warn other people to stay away from the area.
- Immediately notify the proper authorities or people to correct the problem.

	<p>In an electrical emergency: Stay calm and think before you act. Don't become a victim while helping someone else.</p>
---	--

APPROACHING A VEHICLE THAT MAY BE ENERGIZED

In an emergency situation, it may be necessary for ground personnel to operate the Aerial Device. The entire vehicle and any attachments must be considered energized any time the booms are in the vicinity of power lines.

	<p>Operators make sure your ground personnel know the proper operation and emergency procedures for the Aerial Device. Your life may depend on it if you have an accident or are incapacitated.</p>
---	---

If you must approach a vehicle to perform a rescue operation, understand and follow your company policy. It will take precedence over these instructions. You must be very careful not to touch the vehicle and the ground at the same time or your body will be in a circuit and current may pass from foot to foot or foot to hand. The condition of the ground and subsurface will determine the electric gradient around the vehicle.

BEFORE TRYING TO GET ON OR APPROACH THE VEHICLE:

- Is it necessary to approach the vehicle? Can the operator handle the problem from the platform?
- The best procedure is to disconnect or shut off the power to the lines.
- Do not let anyone approach the vehicle until you evaluate where the power line contacts the Aerial Device.
 - Is it above the insulated section of the upper boom?
 - Is it above the lower boom insulated section?
 - Is it below any insulated sections and a direct short to the vehicle?
- If the vehicle is grounded properly:
 - Use a hot stick or hot line tool to perform the operation.
 - Approach the vehicle using the shuffling step.
 - Lay a rubber blanket down by the vehicle and step on it before attempting to jump on the vehicle.
 - Do not touch the ground and the vehicle at the same time. Even a properly grounded vehicle may have a lethal voltage difference between the truck and ground.
- If the vehicle is not grounded:
 - Do not approach the vehicle unless you use insulated blankets to step on as you approach the vehicle. Stepping from one rubber blanket to the next.
 - Use a hot stick or hot line tool to perform the rescue operation while standing on the rubber blanket.
 - As a last resort, jump onto the vehicle.
 - Do not touch the ground and the vehicle at the same time.



TOP CONTROL AND OPTION SHUT OFF

When a situation requires use of lower controls to override the upper controls (such as, injured personnel in the platform). Move the Top Control and Option Shut Off control lever to the “off” position. This will make the upper controls inoperable. Then “lower” control can be used to lower the operator to the ground, provided the hydraulic system is intact. The Control Selector function as an emergency stop by taking oil flow away from the upper controls.

If the operator is unable to operate the Aerial Device, determine if any damage has occurred to make the Aerial Device inoperable. If the situation allows safe operation from the lower controls, override the upper controls and carefully lower the platform to the ground. If the Aerial Device will not operate due to the damage incurred, consider one of the other auxiliary operating procedures presented in the section to solve the problem.

MANUAL ROTATION

If all the hydraulic power sources become inoperable, the Aerial Device rotation system can be actuated manually. Use a 7/8 in. hex socket, an extension, and a ratchet to rotate the input shaft on the gearbox. Actuating the lower rotation control will reduce the effort required for the rotation.

AUXILIARY LET DOWN POWER (OPTIONAL)

The auxiliary let down power system provides power from a DC motor-pump for operation of the Aerial Device in case of a prime power source failure. Controls for auxiliary let down power may be located at the platform, pedestal (optional), and outrigger (optional).

At the platform, the auxiliary let down power is operated by an air cylinder located with the upper controls. To activate this system, push and hold the air cylinder's plunger knob (labeled “Auxiliary Power”) then operate the controls. The pump will engage after a 10 seconds delay. To turn “off” the power, release the air cylinder's plunger knob. The auxiliary let down power system should not be continuously operated longer than 30 seconds. Continuous use will drain the battery and damage (overheat) the motor.

At the pedestal and the outrigger controls (if equipped), the auxiliary let down power is operated by a push button switch. To activate this system, push and hold the switch, the pump will engage after a 10 seconds delay. To turn “off” the power, release the switch. The auxiliary let down power system should not be continuously operated any longer than 30 seconds. Continuous use will drain the battery and damage (overheat) the motor.

Do not use the let down pump as an auxiliary pump. Use the let down pump only to lower the booms and/or raise the outriggers when either the main pump or engine malfunctions. Using the pump to raise the booms may cause damage to the let down pump motor.

When the Aerial Device is equipped with engine two-speed throttle and auxiliary let down power, the same control is used for both. When the engine is running, the engine two-speed throttle operates. When the engine is off, the auxiliary let down power operates.

HYDRAULIC LINE FAILURE

Hydraulic line failure during Aerial Device operation presents numerous hazards. Be aware that a hydraulic oil mist caused by a leak or hydraulic line failure is conductive even though nonconducting oil is used.

	<p>A spray or mist produced by a hydraulic leak under pressure is very hazardous to personnel. This spray or mist can puncture the skin or become embedded beneath the skin. This condition would require immediate medical attention.</p>
---	--

 WARNING

<p>Escaping fluid under pressure can penetrate skin causing serious injury.</p>
<p>Relieve pressure before disconnecting hydraulic lines. Keep away from leaks and pin holes. Use a piece of cardboard or paper to search for leaks. Do not use your hand.</p>
<p>Fluid injected into skin must be surgically removed within a few hours by a doctor familiar with this type injury or gangrene will result.</p>
<p>H23877A</p>

WHAT CAN CAUSE A HYDRAULIC LINE TO FAIL?

- Poorly maintained hydraulic system.
- Improperly assembled and installed hydraulic lines.
- Weather checked hose assemblies.
- Hydraulic tool hoses that are allowed to cross phase to phase or phase to ground.
- Boom contact with phases causing a short circuit, which overheats the hydraulic line.
- Improper system pressure setting.
- Overheating the hydraulic system.
- Snagging of hydraulic lines on fixed objects.



WHAT CAN HAPPEN WHEN HYDRAULIC LINES FAIL?

Hydraulic oil, when confined within the hydraulic system and properly maintained, is non-conductive and not subject to being ignited. There are numerous hazards that develop when there is a hydraulic line separation:

- Personnel may suffer burns from contact with hot oil.
- A vacuum may be created in the line and breach the insulated portion of the booms causing the Aerial Device to be conductive.
- If the hydraulic line failure creates a mist of oil, it very easily can be ignited by any outside source of ignition; such as, electric arcing, sparks, and flames.
- The reservoir may be drained of oil, which will make the Aerial Device inoperable.

WHAT TO DO IF HYDRAULIC LINES FAILS?

A quick response to stop oil flow caused by a hydraulic line failure is important to prevent further damage and prevent injury.

The following sequence can be used to stop the flow.

From The Platform

- Release the function being operated. Shut off tool valve if tool, tool hoses, or tool connections are involved.
- Activate the stop control, which will divert the flow back to the tank.
- Activate the engine stop/start switch, if so equipped. This will stop the engine driving the pump.
- Get ground assistance if all these fail.



The vehicle may be energized. If mounting or operating the vehicle from the ground, use proper personal protective equipment; such as rubber gloves, rubber boots, rubber mats, and/or a hot stick. See Emergency Operation section for procedure to approach vehicle.

From The Vehicle Bed

- Move the control selector at the lower controls to the lower control position. This will stop all flow to upper controls.
- Push the engine stop/start switch, if so equipped. This will stop the engine driving the pump.

From The Ground

- Shut off the pump engine. This will stop the pump.
- Disengage the power take-off. This will stop the pump.
- Move the control selector at the outrigger control valve to the outrigger position. This will stop all flow to the Aerial Device and send it to the outrigger circuit.
- Push the engine stop/start, if so equipped. This will stop the engine driving the pump.

Once the flow is stopped, determine where the line failure is located. The following examples describe some emergency procedures that can be followed for some specific types of hydraulic line failures:

- If the line failure is between the upper and lower controls, overriding the upper controls and only operating from the lower controls may reduce the rate of hydraulic oil loss. The intermittent loss of hydraulic oil may allow the Aerial Device to be stored.
- It may be necessary to use another Aerial Device to bring the operator down.

NOTE: Oil spills may require notifying Local, State, or Federal Authorities.



The Aerial Device must not be operated until repairs have been completed and the Aerial Device cycled from the lower controls to purge air.

ENGINE FAILURE

	If the prime power source fails, the optional auxiliary let down power system can be used for emergency operation. If the auxiliary let down power system is not installed and the vehicle has a manual transmission, then use the engine stop/start control (if so equipped) to crank the engine.
--	--

HYDRAULIC PUMP FAILURE

If the primary hydraulic pump fails, use the auxiliary let down power system, if equipped.

CONTROL VALVE FAILURE

A control valve malfunction could develop in either the individual control levers or the multifunction single stick control.

If the Aerial Device motion cannot be stopped because the control valve will not return to the centered or neutral position, activate the emergency stop mode by pushing down the emergency stop. The emergency stop position will disable the boom controls, which will stop the Aerial Device's motion. If the engine stop/start control is installed, shut off the engine. The engine and the Aerial Device's motion will cease. Then manually attempt to center the spring-loaded control lever before restarting the engine. If the spring-loaded control lever at the platform will not return to neutral, the Aerial Device can be returned to a stowed position by overriding the upper controls from the lower controls.

After any emergency situation, it is the operator's responsibility to notify appropriate maintenance personnel to make sure the Aerial Device is repaired and adjusted.

Identifying the problem and initiating the recommended emergency procedures will help to minimize or possibly prevent injuries.

OPERATIONAL LIMITATIONS

PLATFORM LEVELING SYSTEM

The platform leveling system is designed to carry the rated load of the platform. Collision of the platform(s) with a fixed object, including the ground, or attachment of any load lifting devices to the platform(s) can damage or break the leveling system, causing the platform to be overturned. Avoidance of these hazards and use of OSHA approved fall protection system for all personnel in the platform is essential for protection against this type of accident.

	Do not allow booms or platform to make contact with fixed objects including the ground. Look for possible contact of booms or platform with fixed objects if you feel the platform is not staying level.
--	--

	The platform leveling mechanism is designed to carry the rated platform capacity, applied standing over the center of the platform floor. Hoisting of material from the outer edge of the platform, from a pole attached to and extending over the top of the platform, places excessive loads on the leveling mechanism. This procedure could cause overturning of the platform(s) and ejection of personnel.
--	--

	All platform occupants must wear OSHA approved fall protection system.
--	--



LEAVING THE JOB SITE

1. Articulate jib parallel with the upper boom before storing upper boom. Retract jib fully and pin for travel.
2. Rotate platform to stowed position.
3. Place upper and lower boom in the proper stored position for traveling. Upper boom must be locked in place with hold-down latch. Store booms in rests so boom deflection is removed and boom weight is supported. Do not lower boom down so it deflects downward in the middle.



The upper boom must be completely secured with the hold-down strap in its rest before travel. If the boom is allowed to bounce in its rest, the fiberglass may craze, shatter, and eventually buckle.

4. Retract all outriggers and properly store outrigger pads and chocks.
5. Stow all loose items or equipment.
6. Disengage PTO to prevent damage.
7. Shut off master switch.
8. Make final inspection that everything is properly stored.
9. Turn off warning lights.
10. Disengage brakes.
11. When traveling, remember overall height of vehicle.
12. If any problems were encountered during working operation, report them to the proper person(s) for maintenance and repair.

NOTE: If any problems were encountered during working operation, report them to the proper person(s) for maintenance and repair.

DRIVE CAREFULLY!

SECTION 2
MAINTENANCE GUIDELINES

PREVENTATIVE MAINTENANCE

A preventative maintenance program based on the manufacturer's recommendations shall be established. Dated and detailed inspection and repair records shall be maintained.

It is recommended that the replacement parts for your Aerial Device be obtained from a Terex South Dakota distributor or Terex South Dakota.

MAINTENANCE PROCEDURE

Before maintenance, adjustments, and repairs are started the following precautions shall be taken as applicable:

- You must be authorized by owner to operate unit.
- Place vehicle where it will cause the least interference with other equipment or operations in the area.
- All controls at the off position.
- Starting means rendered inoperative.
- Warning or "OUT OF ORDER" signs placed on the vehicle.
- Power plant stopped or disconnected at power takeoff.
- Relax all hydraulic cylinders used for boom lift and articulation.
- Relieve hydraulic oil pressure from all hydraulic circuits before loosening or removing hydraulic components.

After adjustments and repairs have been made, the Aerial Device shall not be operated until all guards have been reinstalled, trapped air removed from hydraulic system, safety devices reactivated, and maintenance equipment removed.

Warning or "OUT OF ORDER" signs shall be placed and removed by authorized personnel only.

ADJUSTMENTS AND REPAIRS

Any unsafe conditions disclosed by the inspection requirements of this section shall be corrected before operation of the Aerial Device is resumed. Adjustments and repairs shall be done only by qualified personnel.

Adjustments shall be maintained to assure correct functioning of components. The following are examples:

- All functional operating mechanisms.
- Safety devices.
- Control systems.
- Power plants.

Repairs or replacements shall be provided promptly as needed for safe operation. The following are examples:

- All critical parts of functional operating mechanisms which are cracked, broken, corroded, bent or excessively worn. This is for all parts of the Aerial Device, pedestal, subframe, outrigger, and attachments to the vehicle.
- All critical parts of the vehicle structure which are cracked, bent, broken or excessively corroded.
- Hooks showing defects disclosed by "Frequent Inspection" requirements in the maintenance manual shall be discarded. Field repairs by welding or re-shaping shall not be permitted.

All replacement parts or repairs shall have at least the original safety factor. Do not alter, modify, remove or replace any part of the Aerial Device without the approval of the manufacturer.

NOTE: Do not use hoses having less than 3000 PSI (20.69 MPa) working pressure. Only use orange hoses marked "Non-Conductive" for hydraulic tools at the boom tip and in areas that bridge the insulation gap.



LUBRICATION

All moving parts of the Aerial Device and vehicle, for which lubrication is specified, shall be regularly lubricated. Lubricating systems shall be checked for proper delivery of lubricant. Particular care should be taken to follow manufacturer’s recommendations as to points and frequency of lubrication, maintenance of lubricant levels and types of lubricant to be used.

Machinery shall be stationary while lubricants are being applied and protection provided as called for in “Maintenance Procedure”.

	<p>The modification, rework, replacement, or substitution of any part of the Aerial Device with a means not equal to the original equipment provided by the manufacturer may cause serious personal injury.</p>
---	---

GENERAL INFORMATION

1. Keep inspection records up-to-date.
2. Record and report all discrepancies to your supervisor.
3. A dirty Aerial Device and vehicle cannot be properly inspected. Keep your Aerial Device and vehicle clean!
4. Follow vehicle manufacturer’s requirements for inspection, maintenance, and repairs.
5. Only qualified personnel shall do repairs and inspections.
6. Oil spills may require notifying Local, State, or Federal Authorities.!

	<p>The following checklists must be used daily, 90 days (360 hours), 180 days (720 hours), 12 months (1,050 hours) and 5 year (5,250 hours). Failure to do so could endanger the life of the operator. Always remember, preventive maintenance can save much more than it costs.</p>
--	--

NOTE: The following check points listed are the minimum recommended by Terex South Dakota. They are subject to supplementation to conform with your own company regulations.

NOTE: Remember that the safety of all personnel and the operational efficiency of the Aerial Device are dependent upon good inspection checks and maintenance practices.

NOTE: Dirty or dusty conditions or unusual weather conditions may require more frequent maintenance.

	<p>Changes to the vehicle computer settings could affect equipment operation and could result in crushing or tip over that could cause death or serious injury.</p> <ul style="list-style-type: none"> • Do not alter computer settings without full knowledge of affect of changes. • See information supplied with truck manuals and contact final stage manufacturer for required settings.
---	--

FREQUENT AND PERIODIC INSPECTION INTERVALS

DAILY

1. Check controls at platform and lower controls for proper operation.
2. Inspect fall protection equipment and attachments.
3. Inspect visual and audible devices.
4. Check cleanliness and dryness of fiberglass components.
5. Visually check for missing, damaged, or loose covers and guards.
6. Check for missing and illegible warning, operational, or instructional markings.
7. Visually check oil level in hydraulic reservoir.
8. Visually inspect for leaks in hydraulic system.
9. Visually check all cylinders for leaks.
10. Visually inspect leveling system. (Chains and Insulator Assemblies)
11. Visually inspect all fasteners for tightness.
12. Visual inspection of all structural members for cracks and permanent deformation.
13. Check for rotational obstructions.
14. Visual inspection of all electrical wires.
15. Operational test of all boom functions.
16. Visual inspection of winch line and hooks.

90 DAYS (360 HOURS)

1. Check tension on leveling system.
2. Visually inspect all sprockets, chains, pulleys and pins.
3. Lubricate all points per lubrication chart recommendations.
4. Apply lubricant to rotation gearbox pinion and turntable bearing.
5. Repair or replace items found to be worn or damaged.
6. All Daily Items

180 DAYS (720 HOURS)

1. Inspect exposed hoses.
2. Clean hydraulic tank breather.
3. Check tightness of rotation bearing bolts, turntable to bearing, and bearing to pedestal for proper torque.
4. Replace return filter.
5. Daily and 90 day (360 hours) inspections.

12 MONTHS (1,050 HOURS)

1. Replace high-pressure filter.
2. Inspect and lubricate PTO drive shaft to pump.
3. Take samples of hydraulic oil and test.
4. Check all system pressure for proper setting.
5. Perform cylinder drift tests.
6. Perform structural and critical weld inspections.
7. Perform dielectric tests.
8. Daily, 90 days (360 hours) and 180 days (720 hours) inspections.

5 YEAR (5,250 HOURS)

1. Remove leveling chain and leveling rods for inspection.
2. Daily, 90 days (360 hours), 180 days (720 hours) and 12 months (1,050 hours) inspections.



SIDE MOUNT

TEREX TELELECT HI-RANGER TC SERIES

ITEM	LUBRICATION POINT	QTY	LEG	TYPE OF LUBRICATION	METHOD OF APPLICATION
1	CYLINDER BEARING	8	△	LITHIUM BASED EP #2 GREASE	GREASE GUN
2	BOOM PIVOT BEARING	2			
3	ELBOW PIVOT BEARING	2			
4	LINK BEARING	6			
5	ROTATION GEAR TEETH	A/R			
6	ROTATION DRIVE BEARING	1			
7	BASKET SHAFT BEARING	2			
** 8	ROTATION BEARING	1			
9	CHAIN PULLEYS	4			
10	BASKET ROTATOR CYLINDER	2			
11	JIB SHEAVES	2			
12	LEVELING SPROCKET	2			
13	WINCH PIVOT BEARINGS	2			
14	WINCH DRUM BEARINGS	2			
15	JIB CYLINDER PIN	2			
16	BASKET ROTATION PIVOT	4			
17	BASKET LEVELING CYLINDER BEARINGS	4			
18	WINCH SHAFT	1			
19					
20	CONTROL HEAD LINKAGE	A/R		AEROSOL PENETRATING OIL	SPRAY CAN
21	CHAINS	A/R		NON-DETERGENT SAE30	BRUSH
22	CONTROL HEAD AIR PISTON	1		AEROSOL PENETRATING OIL	SPRAY CAN
* 23	HYDRAULIC TANK	1	□	***PREMIUM1S0 15HYD FLUID	FILL IF LOW
24	ROTATION SPEED REDUCER	1	△	MOBILUX EP O23	
25	WINCH SPEED REDUCER	1		GL-5 EP GEARLUBE 85W140	
26	FILTERS	3	REPLACE CARTRIDGE EVERY 360 HRS OR 90 DAYS OF OPERATION		

LUBRICATION LEGEND

□ CHECK DAILY
 △ EVERY 360 HRS OR 90 DAYS OF OPERATION
 USE THE ABOVE PRODUCTS OR EQUIVALENT

*DRAIN AND REFILL WHEN CONTAMINATED
 **LUBRICATE SPARINGLY EVERY 1/8 REVOLUTION
 ***SEE MAINT. MANUAL FOR PROPER FLUID SELECTION. FOR COLD WEATHER APPLICATIONS USE AIRCRAFT HYD FLUID MIL5606A.
 NOTE: ALWAYS RELUBE IF DISASSEMBLED

5,819,543
6,810,993

442582L



WINCH ROPE INSPECTION

All stable braid ropes in continuous service should be visually inspected once every working day. A thorough inspection of all ropes in use should be made at least once a month and a full written, dated and signed report of rope condition kept on file where readily available. All inspection should be performed by an authorized person.

All stable braid ropes installed on a machine which has been idle for a period of one week or more due to shut down or storage should be given a thorough inspection before being placed in service. This inspection should be performed by an authorized person whose approval should be required for further use of the rope. A written and dated report of the rope condition should be filed.

Continued use and normal wear on rope gradually diminishes the ultimate breaking strength and lowers the factor of safety. In determining the proper discard time of stable braid rope, the following guides are suggested:

1. If as many as one half of the cover strands are cut at a given point, this damaged section should be cut out and the rope rejoined with a standard end-for-end splice. If within 10 ft. (3 m) of the eye, put in a new eye splice. It can then be used normally. If a few damaged strands spaced out along the rope at intervals is evident, the rope should be periodically examined.

	<p>Eye splices at the end of the winch line should be done in strict accordance with the steps and procedures outlined by the rope manufacturer.</p>
---	--

2. If the individual cover strands have been worn down after extended use to within 50 percent of their original bulk over an extended area of the line, then the line should be discarded (or assigned to a less critical task). This can best be determined by examination and comparison of the bulk of an individual strand which is exposed and subject to wear with that same strand where it crosses under other strands and is protected (and therefore is full size).

It should be kept in mind that the rope can be cut and damaged by sharp edges. Therefore, it should not be exposed to sharp edges and surfaces such as metal burrs on winch drums, sheaves, etc. When installing rope on older machines, great care must be exercised to assure that the rope does not come in contact with hardware that has been scored and chewed by previously used wire rope lines.

Winch rope has its best dielectric properties when it is new and clean. Dirt, grease, other foreign matter and moisture -humidity- will alter these dielectric properties, thus the rope should be kept clean and dry. The rope can be cleaned by washing in a mild detergent and warm water, rinsed and air dried. Water can be trapped between the fibers and should be squeezed out by placing the line under tension and air-dried.

	<p>The insulating factors of a fiberglass boom or jib can be affected by dirty, wet or contaminated rope.</p>
---	---

The first layer of wraps around the winch drum should be applied closely and tightly with some tension. This will prevent subsequent wraps from slipping down between the turns when tension is applied.

Certain chemicals will break down the fibers of the rope. Chemicals to avoid are sulfuric acids, alkalis, or chlorinated hydrocarbons over 160 degrees F (71 degrees C). Strong cleaning agents or bleaches may also be harmful.

	<p>When replacing rope, make sure the correct rope type is installed. All ropes are not constructed the same and have different ratings.</p>
---	--

DAILY ROPE INSPECTION

The synthetic rope must be inspected daily for any deterioration, resulting in appreciable loss of strength, such as described below.

1. Excessive external roughness.
2. Glossy or glazed areas, which indicates heat damage.
3. Look for flat areas, bumps, or lumps, which indicates core or internal damage.
4. Cut or badly frayed strands.
5. Areas of discoloration, which could be caused by chemical contamination.
6. Stiffness, which would indicate excessive dirt or grit embedded or shock load damage.
7. Open the strands and look for powdered fibers, which means there is internal wear.
8. Inspect eye connection for proper weaving and damage.

If any of the above conditions are found it should be reported to a qualified person to determine if the synthetic rope should remain in service. Further information can be found in the maintenance manual for determining the replacement of the synthetic rope.

If there is any doubt or question about the condition of the synthetic rope -replace it!

HOOK INSPECTION

The load line hook and safety latch must be inspected daily. Any hooks showing defects shall be discarded. Field repairs by welding or re-shaping shall not be permitted.

- Any damaged hook safety latch shall be replaced immediately.
- Any hook or fitting with a crack or distortion shall be removed from service immediately.
- Hook nut (if equipped) should be checked for corrosion or deformation.
- Refer to hook manufacturer for more specific inspection instructions.



Hook latches are to be used only as retention devices to retain loose rigging under slack conditions. They are not intended to be anti-fouling devices and caution must be exercised to prevent a latch from supporting any portion of a load. Periodic inspection of the latch must be made to insure it's proper operating condition. If damage to the latch occurs, the latch must be replaced immediately.



STORAGE PROCEDURE

When a unit will not be used for a period of time, it should be prepared for storage to reduce the deteriorating effects of the environment. This includes the following:

- Wash and clean to remove accumulated road grime. It can discolor the paint if left on for long periods of time.
- Clean and wax the fiberglass components. If storage is in the sun, cover the booms.
- Clean and coat the exposed cylinder rods with grease, preservative spray or heavy preservative oil.
- Clean and grease the exposed valve spools and linkage.
- Lubricate the entire Aerial Device following the lube chart.
- Check the oil for pH level and water content. Acidic oil or water in the oil may settle out during storage and can rust the interior of the hydraulic system.
- Cover the platform to prevent water from accumulating. A platform full of water can weigh over 900 lbs. (408 kg) and exceed the capacity of the platform.
- Ensure the hydraulic tank filler-breather filter is intact to prevent dirt entering the tank when the temperature changes.
- Grease all sliding surfaces where there is metal contact to prevent rust.
- Touch up any bare metal and where the paint is chipped or cracked.
- Spray the electric collector commutators with LPS 1 or CRC 5-56 to prevent corrosion of the surface.
- Service the truck as recommended by the manufacturer.

NOTE: The period of time between uses when the unit should be prepared for storage varies with the location. If the climate is temperate and dry it may be 4 months. If it is in a humid area next to the ocean with the salt air it may be only 2 weeks.

APPENDIX - A

STANDARDS AND REGULATIONS

In addition to the operational instructions provided herein, various standards and governmental regulations must be followed in the use and operation of your Terex South Dakota, Inc. unit.

ANSI STANDARDS

ANSI standards that are applicable to the operation and maintenance of your unit:

1. ANSI A92.2 (latest revision) Vehicle Mounted Elevating and Rotating Aerial Devices,
2. ANSI A10.31 (latest revision) Digger Derricks - Safety Requirements, Definitions and Specifications (A partial extraction is included in this appendix),
3. ANSI C2, Part 4 (latest revision) (National Electric Safety Code®) Rules for the Operation of Electric Supply and Communication Lines and Equipment,
4. ANSI Z133.1 (latest revision) Safety Requirements for Tree Pruning, Trimming, Repairing, or Removal.

For complete, current copies of ANSI standards, you must annually write to the following:

American National Standards Institute
11 West 42nd Street
New York, NY 10036

Copies of the standards can also be found on the Internet at:

www.ansi.org

OSHA REGULATIONS

OSHA regulations that are applicable to the operation and maintenance of your unit:

1. OSHA Subpart V, Power Transmission and Distribution,
2. OSHA 1910.67, Vehicle Mounted Elevating and Rotating Cable Placers,
3. OSHA 1910.268, Telecommunications,
4. OSHA 1910.269, Electrical Power Generation, Transmission and Distribution,
5. OSHA Subpart M, Fall Protection,
6. OSHA 1910.147, The Control Of Hazardous Energy (Lockout/Tagout),
7. OSHA Subpart S, Electrical,
8. OSHA 1910.333, Selection and use of work practices.
9. OSHA Subpart CC, - Cranes and Derricks in Construction

For complete, current copies of OSHA regulations, you must annually write to the following or contact your OSHA Regional Office.

Technical Data Center
Frances Perkins Department Of Labor Building
Room N2439
200 Constitution Avenue
Washington, DC 20210

Copies of the standards can also be found on the Internet at:

www.osha.gov

These are not all inclusive of the applicable codes, standards, or regulations. It is your responsibility and your employer's responsibility to identify and comply with applicable codes, standards and regulations.

The information provided herein is accurate as of the date your Terex South Dakota, Inc. unit was manufactured. You must comply with the codes, standards and regulations as they are updated over time. It is your employer's responsibility to obtain copies and comply with all standards and regulations.



OSHA EXCERPTS: (CLEARANCE DISTANCE)

The following are excerpts from OSHA Standards. They are not complete and do not cover all safety work rules.

PARTIAL EXCERPT FROM SUBPART S - ELECTRICAL: (02-01-1998 EDITION)

1910.333 Selection and use of work practices.

(c), (i) Unqualified person.

(A) When an unqualified person is working in an elevated position near overhead lines, the location shall be such that the person and the longest conductive object he or she may contact cannot come closer to any unguarded, energized overhead line than the following distances:

1. For voltages to ground 50kV or below - 10 feet (3.05 m);
2. For voltages to ground over 50kV - 10 feet (3.05 m) plus four inches (101.6 mm) for every 10kV over 50kV.

(B) When an unqualified person is working on the ground in the vicinity of overhead lines, the person may not bring any conductive object closer to unguarded, energized overhead lines than the distances given in paragraph (c)(3)(i)(A) of this section.

NOTE: For voltages normally encountered with overhead power line, objects which do not have an insulating rating for the voltage involved are considered to be conductive.

EXCERPT FROM OSHA SUBPART V - POWER TRANSMISSION AND DISTRIBUTION (11-14-1990 EDITION)

1926.950 General Requirements (c) Clearances. The provisions of paragraph (1) or (2) of this section shall be observed.

(1) No employee shall be permitted to approach or take any conductive object without an approved insulating handle closer to exposed energized parts than shown in Table V-1, unless:

- (i) The employee is insulated or guarded from the energized part (gloves or sleeves rated for the voltage involved shall be considered insulation of the employee from the energized part), or
- (ii) The energized part is insulated or guarded from him and any other conductive object at different potential, or
- (iii) The employee is isolated, insulated, or guarded from any other conductive object(s), as during live-line bare-hand work.

(2)(i) The minimum working distance and minimum clear hot stick distances stated in Table V-1 shall not be violated. The minimum clear hot stick distance is that for the use of line-line tools held by lineman when performing live-line work. (e)(15) The minimum clearance distances for live-line bare-hand work shall be as specified in Table V-2. These minimum clearance distances shall be maintained from all grounded objects and from lines and equipment at a different potential than that to which the insulated Cable Placer is bonded unless such grounded objects or other lines and equipment are covered by insulated guards. These distances shall be maintained when approaching, leaving and when bonded to the energized circuit.

ALTERNATING CURRENT MINIMUM DISTANCES	
VOLTAGE RANGE (PHASE-TO-PHASE) KILOVOLT	MINIMUM WORKING AND CLEAR HOT STICK DISTANCES
2.1 to 15	2 ft. 0 in. (0.61 m)
15.1 to 35	2 ft. 4 in. (0.71 m)
35.1 to 46	2 ft. 6 in. (0.76 m)
46.1 to 72.5	3 ft. 0 in. (0.91 m)
72.6 to 121	3 ft. 4 in. (1.02 m)
138 to 145	3 ft. 6 in. (1.07 m)
161 to 169	3 ft. 8 in. (1.12m)
230 to 242	5 ft. 0 in. (1.52 m)
345 to 362	1 7 ft. 0 in. (2.13 m)
500 to 552	1 11 ft. 0 in. (3.35 m)
700 to 765	1 15 ft. 0 in. (4.57 m)

TABLE V-1

MINIMUM CLEARANCE DISTANCES FOR LIVE-LINE BARE-HAND WORK (ALTERNATING CURRENT)		
VOLTAGE RANGE (PHASE-TO-PHASE) KILOVOLT	DISTANCE IN FEET AND INCHES FOR MAXIMUM VOLTAGE	
	PHASE-TO-GROUND	PHASE-TO-PHASE
2.1 to 15	2 ft. 0 in. (.61m)	2 ft. 0 in. (.61m)
15.1 to 35	2 ft. 4 in. (.71m)	2 ft. 4 in. (.71m)
35.1 to 46	2 ft. 6 in. (.76m)	2 ft. 6 in. (.76m)
46.1 to 72.5	3 ft. 0 in. (.91m)	3 ft. 0 in. (.91m)
72.6 to 121	3 ft. 4 in. (1.02m)	4 ft. 6 in. (1.37m)
138 to 145	3 ft. 6 in. (1.07m)	5 ft. 0 in. (1.52m)
161 to 169	3 ft. 8 in. (1.12m)	5 ft. 6 in. (1.68m)
230 to 242	5 ft. 0 in. (1.52m)	8 ft. 4 in. (2.54m)
345 to 362	1 7 ft. 0 in. (2.13m)	1 13 ft. 4 in.(4.06m)
500 to 552	1 11 ft. 0 in. (3.35m)	1 20 ft. 0 in.(6.1m)
700 to 765	1 15 ft. 0 in. (4.57m)	31 ft. 0 in.(9.45m)

TABLE V-2

NOTE: Table V-1 - 1 For 345-362kv, 500-552kvb and 700-765kv, the minimum working distance and the minimum clear hot stick distance may be reduced provided that such distances are not less than the shortest distance between the energized part and a grounded surface.











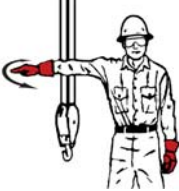



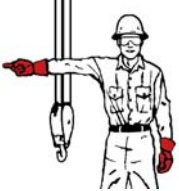

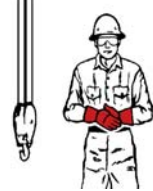
NOTE: Table V-2 - 1 For 345-362kv, 500-552kv and 700-765kv, the minimum clearance distance may be reduced provided the distances are not made less than the shortest distance between the energized part and a grounded surface.

OSHA SUBPART CC

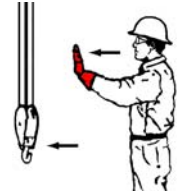
Depending on the work being performed operation near power lines must follow OSHA 1926.1408 and 1409. This includes maintaining at least 20 foot (6.1m) clearance up to 50 feet (15.2m) depending on the voltage. All personnel must be trained of the hazards when working near or on power lines.

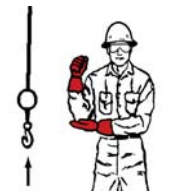

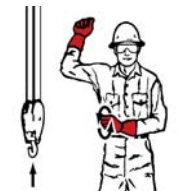
STANDARD HAND SIGNALS

 <p>STOP. With arm extended horizontally to the side, palm down, arm is swung back and forth.</p>	 <p>EMERGENCY STOP. With both arms extended horizontally to the side, palms down, arms are swung back and forth.</p>	 <p>HOIST. With upper arm extended to the side, forearm and index finger pointing straight up, hand and finger make small circles.</p>	 <p>RAISE BOOM. With arm extended horizontally to the side, thumb points up with other fingers closed.</p>	
 <p>SWING. With arm extended horizontally, index finger points in direction that boom is to swing.</p>	 <p>RETRACT TELESCOPING BOOM. With hands to the front at waist level, thumbs point at each other with other fingers closed.</p>	 <p>RAISE THE BOOM AND LOWER THE LOAD. With arm extended horizontally to the side and thumb pointing up, fingers open and close while load movement is desired.</p>	 <p>DOG EVERYTHING. Hands held together at waist level.</p>	 <p>LOWER. With arm and index finger pointing down, hand and finger make small circles.</p>
 <p>LOWER BOOM. With arm extended horizontally to the side, thumb points down with other fingers closed.</p>	 <p>EXTEND TELESCOPING BOOM. With hands to the front at waist level, thumbs point outward with other fingers closed.</p>	 <p>TRAVEL/TOWER TRAVEL. With all fingers pointing up, arm is extended horizontally out and back to make a pushing motion in the direction of travel.</p>	 <p>LOWER THE BOOM AND RAISE THE LOAD. With arm extended horizontally to the side and thumb pointing down, fingers open and close while load movement is desired.</p>	 <p>MOVE SLOWLY. A hand is placed in front of the hand that is giving the action signal.</p>
 <p>USE AUXILIARY HOIST (WHIPLINE). With arm bent at elbow and forearm vertical, elbow is tapped with other hand. Then regular signal is used to indicate desired action.</p>	 <p>CRAWLER CRANE TRAVEL, BOTH TRACKS. Rotate fists around each other in front of body; direction of rotation away from body indicates travel forward; rotation toward body indicates travel backward.</p>	 <p>USE MAIN HOIST. A hand taps on top of the head. Then regular signal is given to indicate desired action.</p>	 <p>CRAWLER CRANE TRAVEL, ONE TRACK. Indicate track to be locked by raising fist on that side. Rotate other fist in front of body in direction that other track is to travel.</p>	 <p>TROLLEY TRAVEL. With palm up, fingers closed and thumb pointing in direction of motion, hand is jerked horizontally in direction trolley is to travel.</p>

NOTE: Not all signals can be used on Digger Derricks.

APPENDIX - B

RESPONSIBILITIES

ANSI A92.2-2009 (PARTIAL)

Table of Contents:

7.	Responsibilities of Dealers and Installers.	B - 1
8.	Responsibilities of Owners.	B - 2
9.	Responsibility of Users.	B - 5
10.	Responsibilities of Operators.	B - 7
11.	Responsibilities of Lessors or Lessees.	B - 9
12.	Responsibilities of Brokers.	B - 10

7. RESPONSIBILITIES OF DEALERS AND INSTALLERS.

7.1 General Responsibilities. Each dealer or installer as applicable shall comply with the requirements of this section.

7.2 Vehicle Specifications. Each dealer or installer, or both, who sells an aerial device shall inform the owner or user, or both, of the manufacturer’s minimum vehicle specifications.

7.3 Vehicle Weight Distribution. The installer shall be responsible for the weight distribution of the completed mobile unit in accordance with the requirements of the aerial device and the applicable regulations. Allowance shall be made for the weight of readily removable tools and material specified by the user.

7.4 Manuals. Upon delivery of the equipment to the owner or user, the dealer or installer shall provide the manuals as required by Paragraph 6.4 of this standard and manuals for auxiliary equipment added by the installer.

7.5 Installations. The installer shall comply with Sections 5 and 6 of this standard relating to proper installation and shall follow the instructions of the manufacturer. In the event the original manufacturer no longer exists, an equivalent entity may provide these instructions. The installer shall maintain access to the lower controls as described in section 4.3.3. The installer of the aerial device shall, before the mobile unit is placed in operation, perform stability tests in accordance with the requirements of 4.5.1 and 4.5.2, the operational and visual tests in accordance with the requirements of 6.6.1 and 6.6.2, and the appropriate electrical tests required in 5.4 of this standard. For insulating aerial devices, the installer shall assure conformance to the Qualification test requirements of 5.3.2 by either obtaining a certification of the test and performing a periodic test after installation, or by performing the Qualification test. The installer shall, when installing an aerial device on a chassis which is a highway vehicle, comply with all requirements of the applicable Federal Motor Vehicle Safety Standards in effect at the time of installation. Certification as a manufacturer (alteration, intermediate or final) of a motor vehicle under the Federal Motor Vehicle Safety Standards is required. The travel height of the mobile unit shall be posted in a location that is readily visible to the vehicle operator.

7.6 Quality Assurance. The installer shall have a documented quality assurance program which will ensure compliance with this standard.

7.7 Weldings. All welds made by the installer, whose failure could result in motion of the platform(s) shall meet the Structural Welding Code AWS D1.1-2006 and AWS DI.2-2003. The installer shall establish applicable welding quality assurance procedures for all weldments.

7.8 Training. The dealer or installer shall offer training or training materials that aid owners, users, lessors and lessees in the operation, inspection, testing and maintenance of the aerial device. This training shall be offered initially and subsequently on request.



7.8.1 Dealer or Installer as User. Whenever a dealer or installer directs personnel to operate an aerial device (inspecting, sales demonstrations, or any form of use), the dealer or installer shall assume the responsibilities of users as specified in Section 9 of this standard. All personnel authorized to operate the aerial device shall have been trained in a program that meets the requirements of this standard.

7.9 Maintenance Training. Dealer maintenance personnel shall be trained in inspection, testing and maintenance of the aerial device in accordance with the manufacturer's recommendations.

8. Responsibilities of Owners.

8.1 General Responsibilities. Each owner shall comply with the requirements of this section. The following responsibilities pertain to the owner's inspection, testing, maintenance, modification, training and transfer of ownership. These activities shall be performed by qualified person(s).

8.2 Inspection and Testing Classifications.

8.2.1 Initial Inspection and Test. Prior to initial use, all new or modified mobile units shall be inspected and tested to ensure compliance with the provisions of this standard. Certification by the manufacturer, dealer, final installer or an equivalent entity(s), meets this requirement.

8.2.2 Regular Inspection and Tests. The inspection procedure for mobile units is divided into two classifications based upon the intervals at which inspections and tests shall be performed. Intervals shall be set by the owner in accordance with the manufacturer's recommendations. Such intervals are dependent upon component function and exposure to wear, deterioration and other agents which adversely affect component life. Two classifications are designated:

- (1) Frequent Inspection and Test: Daily to monthly intervals.
- (2) Periodic Inspection and Test: One to twelve month intervals.

8.2.3 Frequent Inspection and Test. Items determined by the owner in accordance with the manufacturer's recommendations for each specific aerial device shall be inspected. The following inspections and tests shall be performed by the operator prior to first use at the beginning of each shift:

- (1) Conduct walk around visual inspection looking for damaged components, cracks or corrosion, excessive wear and any loose, deformed or missing bolts, pins, fasteners, locking devices and covers.
- (2) Check all controls and associated mechanisms for proper operation to include, but not limited to, the following:
 - (a) Proper operation of interlocks.
 - (b) Controls return to neutral when released and not sticking.
 - (c) Control function and operation clearly marked.
- (3) Check visual and audible safety devices for proper operation.
- (4) Visually inspect fiberglass and insulating components for visible damage or contamination.
- (5) Check for missing or illegible operational and instructional markings.
- (6) Check hydraulic and pneumatic systems for observable deterioration and excessive leakage.
- (7) Check electrical systems related to the aerial device for malfunctions, signs of excessive deterioration, dirt and moisture accumulation.
- (8) Perform functional test to include, but not limited to, the following:
 - (a) Set-up the aerial device for operation, including outriggers.
 - (b) Cycle the aerial device functions through the complete range of motion from the lower controls, except where operation through the complete range of motion would create a hazard.
 - (c) Check functionality of emergency controls.

Any suspected items shall be carefully examined or tested and a determination made by a qualified person as to whether they constitute a safety hazard. All unsafe items shall be replaced or repaired before use.

APPENDIX B

8.2.4 Periodic Inspection or Test. An inspection of the mobile unit shall be performed at the intervals defined in 8.2.2 depending upon its activity, severity of service, and environment, or as specifically indicated below. (These inspections shall include the requirements of 8.2.3):

- (1) Structural members for deformation, cracks or corrosion.
- (2) Parts, such as pins, bearings, shafts, gears, rollers, locking devices, chains, chain sprockets, wire and synthetic ropes and sheaves for wear, cracks or distortion.
- (3) Hydraulic and pneumatic relief valve settings.
- (4) Hydraulic system for proper oil level.
- (5) Hydraulic and pneumatic fittings, hoses and tubing for evidence of leakage, abnormal deformation or excessive abrasion.
- (6) Compressors, pumps, motors and generators for loose fasteners, leaks, unusual noises or vibrations, loss of operating speed and excessive heating.
- (7) Hydraulic and pneumatic valves for malfunction and visible cracks in the external valve housing, leaks and sticking spools.
- (8) Visually inspect any vacuum prevention systems and verify function of such systems.
- (9) Hydraulic and pneumatic cylinders and holding valves for malfunction and visible damage.
- (10) Hydraulic and pneumatic filters for cleanliness and the presence of foreign material in the system indicating other component deterioration.
- (11) Electrical systems and components for deterioration or wear including those not readily visible on a frequent inspection.
- (12) Performance test of all boom movements.
- (13) Condition and tightness of bolts and other fasteners in accordance with the manufacturer's recommendation.
- (14) Welds, as specified by the manufacturer.
- (15) Legible and proper identification, operational and instructional markings.
- (16) If the aerial device is rated as an insulating device, the electrical insulating components and system(s) shall be thoroughly inspected for lack of cleanliness and other conditions that compromise insulation. Then these components and system(s) shall be tested for compliance with the rating of the aerial device in accordance with one of the applicable methods and procedures as outlined in Section 5.4.3 of this standard:
 - (a) If the aerial device is used for AC bare-hand work, the "in the field" tests outlined in 5.4.3.1 (10) (c) may be relied upon when performed frequently, however the unit shall undergo an AC voltage test at least every three years in accordance with Table 2 criteria;
 - (b) If the aerial device is used for DC bare-hand work, the "in the field" tests outlined in 5.4.3.1 (10) (c) may be relied upon when performed frequently, however the unit shall undergo an appropriate DC over voltage test at least every three years;
 - (c) After repair or replacement of any component that crosses the insulating system(s), or the repair or replacement of an insulating component(s), (e.g., hoses, leveling rods, boom coating, etc.), the unit shall be dielectrically tested in accordance with Section 5.4.3;
 - (d) An insulated replacement boom shall be tested to ensure conformance to 5.3.3 by the supplier;
 - (e) Bare-hand work units shall be tested for the applicable unit rating in accordance with Table I (or appropriate DC test for units used on direct current lines, see Appendix B) after any major repair to the insulating boom or any insulating boom replacement. Major repair to the insulating boom shall include resurfacing or repainting of the exterior or interior boom surfaces. The removal and subsequent reinstallation of a gradient control device is not considered a "major repair" provided proper reinstallation of the gradient control device is performed by a qualified person in accordance with the manufacturer's instructions.
- (17) If the aerial device has upper controls equipped with high electrical resistance components and the manufacturer so indicates, they shall be maintained as high electrical resistance components and should be electrically tested per 5.4.3.6.

Any suspected items shall be carefully examined or tested and a determination made by a qualified person as to whether they constitute a safety hazard. All unsafe items shall be replaced or repaired before use.



8.2.5 Post Event Inspection or Test. After any reported event during which structural members of an aerial device or mobile unit are suspected of being subjected to loading or stresses in excess of design stress such as after an accident involving overturning of the mobile unit or application of unintended external mechanical or electrical forces to the aerial device, the aerial device shall be removed from service and subjected to the applicable periodic inspection requirements in 8.2.4. In addition to the periodic inspection, supplemental non-destructive examination procedures or other tests to assist in detecting possible structural damage to the aerial device may be required. All damaged items shall be replaced or repaired before the unit is returned to service. Return to service shall be approved by a qualified person.

8.3 Inspection and Test Records.

8.3.1 Frequent. Items to be inspected shall be designated to the operator or other authorized person making frequent inspections. Records of frequent inspections need not be made. However, where a safety hazard is found, it shall be reported in writing to a person responsible for the corrective action and that report and a record of the correction shall be maintained for five years, or as required by applicable regulations.

8.3.2 Periodic. Written, or appropriately archived electronic, dated and signed reports and records shall be made of periodic inspections and tests and retained for a period of five years or as required by applicable regulations.

8.4 Maintenance. Maintenance and frequency of maintenance shall be determined by the owner in accordance with the manufacturer's recommendations.

8.4.1 Maintenance Training. The owner shall train their maintenance personnel in inspection and maintenance of the aerial device in accordance with the manufacturer's recommendations and Section 8 of this standard.

8.4.2 Weldings. Welding repairs of components or welds, designated as critical in the manufacturer's manual shall be made in accordance with the manufacturer's recommendations and shall meet the Structural Welding Code AWS D1.1-2006 or AWS D1.2-2003. Should the original manufacturer no longer exist, and equivalent entity may determine the required procedure.

8.5 Modifications. No modifications or additions which affect the stability, mechanical, hydraulic, or electrical integrity or the safe operation of the aerial device shall be made without the written approval of the manufacturer. If such modifications or changes are made, the capacity, operation and maintenance instruction markings shall be changed accordingly. In no case shall the safety factors be reduced below those specified in this standard or below the manufacturers design safety factors, whichever are greater. Should the original manufacturer no longer exist, an equivalent entity may approve required modification.

8.5.1 Alterations. Altering or disabling the function of safety devices, guards, or interlocks, if so equipped, is prohibited.

8.6 Weight Distribution. Changes in loading or additions made to the mobile unit after the final acceptance that affect weight distribution shall meet applicable regulations by governmental agencies. In no case shall axle loads of the fully loaded vehicle exceed the Gross Axle Weight Ratings (GAWR) assigned by the manufacturer. **Note: Any change in weight distribution may adversely affect stability.**

8.7 Transfer of Ownership. When a change in ownership of an aerial device occurs, it shall be the responsibility of the seller to provide the manufacturer's manual(s) for that aerial device to the purchaser. It is the responsibility of the purchaser to notify the manufacturer of the unit model and serial number and the name and address of the new owner within 60 days. If the owner uses other entities as agents (e.g., Brokers) for the sale or the arrangement of a sale of an aerial device(s) their responsibilities under this section continue.

8.8 Markings. The markings on the aerial device shall not be removed, defaced, or altered. All missing or illegible markings shall be promptly replaced.

8.9 Parts. When parts or components are replaced they shall be identical in specification and function to the original aerial device parts or components or shall provide an equal or greater factor of safety.

8.10 Safety Bulletins. Owners shall comply with safety related bulletins as received from the manufacturer, dealer or installer.

8.11 Manuals. The owner shall insure that the operating manual(s) is stored on the mobile unit.

8.12 Training, Retraining and Familiarization of Operators.



APPENDIX B

8.12.1 General Training. Only personnel who have received general instructions regarding the inspection, application and operation of aerial devices, including recognition and avoidance of hazards associated with their operation, shall operate an aerial device. Such items covered shall include, but not necessarily be limited to, the following issues and requirements:

- (1) The purpose and use of manuals.
- (2) That operating manuals are an integral part of the aerial device and must be properly stored on the vehicle when not in use.
- (3) A pre-start inspection.
- (4) Responsibilities associated with problems or malfunctions affecting the operation of the aerial device.
- (5) Factors affecting stability.
- (6) The purpose of placards and decals.
- (7) Workplace inspection.
- (8) Applicable safety rules and regulations, such as Part 4, ANSI C2-2007, National Electrical Safety Code (applies to utility workers as defined in ANSI C2). The above standard is an example; other industries using aerial devices have safety rules pertinent to that industry.
- (9) Authorization to operate.
- (10) Operator warnings and instructions.
- (11) Actual operation of the Aerial Device. Under the direction of a qualified person, the trainee shall operate the aerial device for a sufficient period of time to demonstrate proficiency in the actual operation of the aerial device.
- (12) Proper use of personal fall protection equipment. Fall protection systems criteria and practices are covered in 29 CFR 1926.502.

8.12.2 Retraining. The operator shall be retrained, when so directed by the user, based on the user's observation and evaluation of the operator.

8.12.3 Familiarization. When an operator is directed to operate an aerial device they are not familiar with, the operator, prior to operating, shall be instructed regarding the following items:

- (1) The location of the manuals.
- (2) The purpose and function of all controls.
- (3) Safety devices and operating characteristics specific to the aerial device.
- (4) Under the direction of a qualified person, the trainee shall operate the aerial device for a sufficient period of time to demonstrate proficiency in the actual operation of the aerial device.

8.13 Owner as a Lessor. When owners function as lessors, they shall have the same responsibilities as specified under Section 11 of this standard.

9. Responsibility of Users.

9.1 General Responsibilities. Each User shall comply with the requirements of this section.

9.2 Personnel. Only trained and authorized personnel shall be permitted to operate the aerial device.

9.3 Training, Retraining and Familiarization of Operators.

9.3.1 General Training. Only personnel who have received general instructions regarding the inspection, application and operation of aerial devices, including recognition and avoidance of hazards associated with their operation, shall operate an aerial device. Such items covered shall include, but not necessarily be limited to, the following issues and requirements:

- (1) The purpose and use of manuals.
- (2) That operating manuals are an integral part of the aerial device and must be properly stored on the vehicle when not in use.
- (3) A pre-start inspection.
- (4) Responsibilities associated with problems or malfunctions affecting the operation of the aerial device.
- (5) Factors affecting stability.



- (6) The purpose of placards and decals.
- (7) Workplace inspection.
- (8) Applicable safety rules and regulations, such as Part 4, ANSI C2-2007, National Electrical Safety Code (applies to utility workers as defined in ANSI C2). The above standard is an example; other industries using aerial devices have safety rules pertinent to that industry.
- (9) Authorization to operate.
- (10) Operator warnings and instructions.
- (11) Actual operation of the Aerial Device. Under the direction of a qualified person, the trainee shall operate the aerial device for a sufficient period of time to demonstrate proficiency in the actual operation of the aerial device.
- (12) Proper use of personal fall protection equipment. Fall protection systems criteria and practices are covered in 29 CFR 1926.502.

9.3.2 Retraining. The operator shall be retrained, when so directed by the user, based on the user's observation and evaluation of the operator.

9.3.3 Familiarization. When an operator is directed to operate an aerial device with which they are not familiar, they shall receive prior instruction regarding the following items:

- (1) The location of the manuals.
- (2) The purpose and function of all controls.
- (3) Safety devices and operating characteristics specific to the aerial device.
- (4) Under the direction of a qualified person, the trainee shall operate the aerial device for a sufficient period of time to demonstrate proficiency in the actual operation of the aerial device.

9.3.4 Proof of Training. Users providing training should provide successful trainees a means to evidence their training and should provide such proof if requested by the trainee. The document evidencing training shall include the following information:

- (1) Name of trainee.
- (2) Name of entity providing training or retraining.
- (3) Name of trainer(s).
- (4) Clear identification of the make(s) and model(s) of the mobile unit(s) on which the operator has been trained.

9.4 Application. The employer and authorized operator(s) shall insure that the aerial device is used only for intended applications as defined in the operating manual and that recognized safety practices are observed. The User is directed to Appendix C for guidance as to appropriate applications.

9.5 Electrical Hazard. All applicable safety related work practices intended to protect from electrical hazards shall be defined and explained to the operator by a qualified person. The operator shall maintain the appropriate Minimum Approach Distance (MAD) from energized conductors and apparatus commensurate with the operator's qualification. See Appendix F for the information on the Minimum Approach Distances and other precautions.

9.6 Bare-Hand Work. For bare-hand work, a Category A aerial device shall be used.

9.7 Lower Controls. The lower controls of aerial devices shall not be used for continuous operation with personnel in the platform.

9.8 Manufacturer's Safety Bulletins. The user shall comply with the applicable safety-related bulletins as received from the manufacturer, installer, dealer or owner.

10. Responsibilities of Operators.

10.1 General Responsibilities. Each operator shall comply with the requirements of this section.

10.2 Personnel. Only trained and authorized personnel shall be permitted to operate the aerial device.

10.3 Operation. During operation of the aerial device all platform occupants shall use appropriate fall protection connected to the aerial device anchorage(s).



APPENDIX B

10.4 Work Platform. The operator shall not use railing, planks, ladders or any other device in or on the work platform for achieving additional working height or reach.

10.5 Brakes. The vehicle parking brake(s) shall be set at all times that the boom is elevated except when the aerial device is being used in accordance with 10.11.

10.6 Loading. Any loading which includes a horizontal load shall be avoided unless the mobile unit is designed for the application.

10.7 Alterations. Altering or disabling the function of safety devices, guards, or interlocks if so equipped shall be prohibited.

10.8 Observations. Observations during operation for any malfunctions shall be conducted on an ongoing basis.

10.8.1 Pre-start Inspection. Items determined by the owner in accordance with the manufacturer's recommendations for each specific aerial device shall be inspected prior to each day's operation. The following tests and inspections shall be performed by the operator once daily, prior to first use:

(1) Conduct walk around visual inspection, looking for damaged components, cracks or corrosion, excessive wear and any loose, deformed or missing bolts, pins, fasteners, locking devices and covers.

(2) Check all controls and associated mechanisms for proper operation to include, but not limited to, the following:

- (a) Proper operation of interlocks.
- (b) Controls return to neutral when released and not sticking.
- (c) Control functions and operation clearly marked.

(3) Check visual and audible safety devices for proper operation.

(4) Visually inspect fiberglass and other insulating components for visible damage and contamination.

(5) Check for missing or illegible operational and instructional markings.

(6) Check hydraulic or pneumatic systems for observable deterioration and excessive leakage.

(7) Check electrical systems related to the aerial device for malfunction, signs of excessive deterioration, dirt and moisture accumulation.

(8) Perform functional test to include, but not limited, to the following:

- (a) Set-up aerial device for operation, including outriggers.
- (b) Cycle each aerial device boom function through its complete range of motion from the lower controls, except where operation through the complete range of motion would create a hazard.
- (c) Check functionality of emergency controls.

Any suspected items shall be carefully examined or tested and a determination made by a qualified person as to whether they constitute a safety hazard. All unsafe items shall be replaced or repaired before use.

10.9 Worksite. Before the aerial device is used the worksite shall be surveyed for hazards such as:

(1) Insufficient supporting surfaces such as soft ground or tamped earth fills.

(2) Ditches.

(3) Excessive slopes, drop-offs, curbs, and floor obstructions.

(4) Debris.

(5) Overhead obstructions and electrical conductors.

(6) Weather conditions.

(7) Presence of unauthorized persons.

(8) Road or worksite traffic.

(9) Subsurface chambers such as underground utility components or septic systems.

10.10 Precautions. Before and during each use the operator shall:

- (1) Check for overhead obstructions and electrical conductors.
- (2) Insure that the load on the platform and/or load lifting device is in accordance with the manufacturer's rated capacity.
- (3) Insure that outriggers and stabilizers are used if the manufacturer's instructions require their use.
- (4) Insure that guardrails are properly installed, and the gates are closed.
- (5) Use outrigger pads when necessary to provide firm footing.

10.11 Mobile Operation. Before engaging in mobile operation the operator shall determine that the aerial device is specifically designed for mobile operation.

10.11.1 Driver Precautions. Before and during driving, the driver shall:

- (1) Avoid traveling on any surface that adversely affects vehicle stability.
- (2) Maintain a safe distance from obstacles and overhead lines.
- (3) Maintain communications between driver and operator.
- (4) Under all travel conditions, the driver shall limit travel speed in accordance with condition of the ground surface, congestion and slope.

10.12 Training, Retraining and Familiarization of Operators.

10.12.1 General Training. Only personnel who have received general instructions regarding the inspection, application and operation of aerial devices, including recognition and avoidance of hazards associated with their operation, shall operate an aerial device. Such items covered shall include, but not necessarily be limited to, the following issues and requirements:

- (1) The purpose and use of manuals.
- (2) That operating manuals are an integral part of the aerial device and must be properly stored on the vehicle when not in use.
- (3) A pre-start inspection.
- (4) Responsibilities associated with problems or malfunctions affecting the operation of the aerial device.
- (5) Factors affecting stability.
- (6) The purpose of placards and decals.
- (7) Workplace inspection.
- (8) Applicable safety rules and regulations, such as Part 4, ANSI C2-2007, National Electrical Safety Code (applies to utility workers as defined in ANSI C2). The above standard is an example; other industries using aerial devices have safety rules pertinent to that industry.
- (9) Authorization to operate.
- (10) Operator warnings and instructions.
- (11) Proper use of personal fall protection equipment. Fall protection systems criteria and practices are covered in 29 CFR 1926.502.

10.12.2 Retraining. The operator shall be retrained, when so directed by the user, based on the user's observation and evaluation of the operator.

10.12.3 Familiarization. When an operator is directed to operate an aerial device with which they are not familiar, they shall be instructed, prior to operating the aerial device, regarding the following items and issues:

- (1) The location of the manuals.
- (2) The purpose and function of all controls.
- (3) Safety devices and operating characteristics specific to the aerial device.
- (4) Under the direction of a qualified person, the trainee shall operate the aerial device for a sufficient period of time to demonstrate proficiency in the actual operation of the aerial device.



APPENDIX B

10.13 Electrical Hazard. All applicable safety related work practices intended to protect personnel from electrical hazards shall be defined and explained to the operator by a qualified person. The operator shall maintain the appropriate Minimum Approach Distance (MAD) from energized conductors and apparatus commensurate with the operator's qualification. See Appendix F for information on the Minimum Approach Distance and other precautions.

11. Responsibilities of Lessors or Lessees.

11.1 General Responsibilities. Each renter or lessor or lessee shall comply with the requirements of the applicable section or sections below.

11.1.1 Lessor or Lessee as Dealer or Installer. When a lessor or lessee uses the aerial device as a dealer or installer they shall have the same responsibilities as specified under Section 7 of this standard.

11.1.2 Lessor or Lessee as Owner. When a lessor or lessee uses the aerial device as an owner they shall have the same responsibilities as specified under Section 8 of this standard.

11.1.3 Lessor or Lessee as User. When a lessor or lessee uses the aerial device as a user they shall have the same responsibilities as specified under Section 9 of this standard.

11.1.4 Lessor or Lessee as Operator. When a lessor or lessee uses the aerial device as an operator they shall have the same responsibilities as specified under Section 10 of this standard.

11.2 Ownership Responsibilities. The lessor shall carry out the responsibilities of ownership specified in this standard which are not assigned to the lessee as the user.

11.3 Obligations. Upon delivery each lessor of an aerial device shall provide the operators manual and the ANSI/SIA A92.2-2009 Manual of Responsibilities for dealers, owners, users, operators, lessors, lessees and brokers of Vehicle Mounted Elevating and Rotating Aerial Devices. These manuals shall be stored on the mobile unit.

11.3.1 Inspection and Test. Prior to delivery, the lessor of an aerial device shall perform a frequent inspection as specified in Section 8.2.3 of this standard.

11.3.2 Responsibilities. Upon delivery, each lessor of an aerial device shall inform the lessee of their responsibilities in accordance with Section 8 as to inspection, testing and maintenance requirements; Section 9 as to user's responsibilities; and Section 10 as to operator's responsibilities.

11.4 Training. The lessor shall offer training or training materials that aid the lessee in the operation, inspection, testing and maintenance of the aerial device. This training shall be offered initially and subsequently on request.

11.4.1 General training. Only personnel who have received general instructions regarding the inspection, application and operation of aerial devices, including recognition and avoidance of hazards associated with their operation, shall operate an aerial device. Such items covered shall include, but not necessarily be limited to, the following issues and requirements:

- (1) The purpose and use of manuals.
- (2) That operating manuals are an integral part of the aerial device and must be properly stored on the vehicle when not in use.
- (3) A pre-start inspection.
- (4) Responsibilities associated with problems or malfunctions affecting the operation of the aerial device.
- (5) Factors affecting stability.
- (6) The purpose of placards and decals.
- (7) Workplace inspection.
- (8) Applicable safety rules and regulations, such as Part 4, ANSI C2-2007, National Electrical Safety Code (applies to utility workers as defined in ANSI C2). The above standard is an example; other industries using Aerial Devices have safety rules pertinent to that industry.
- (9) Authorization to operate.
- (10) Operator warnings and instructions.
- (11) Proper use of personal fall protection equipment. Fall protection systems criteria and practices are covered in 29 CFR 1926.502.



(12) Electrical hazards and Minimum Approach distance to energized conductors and apparatus. See Appendix F.

11.4.2 Familiarization. When an operators are directed to operate an aerial device with which they are not familiar, they shall be instructed, prior to operating the aerial device, regarding the following items:

- (1) The location of the manuals.
- (2) The purpose and function of all controls.
- (3) Safety devices and operating characteristics specific to the aerial device.
- (4) Under the direction of a qualified person, the trainee shall operate the aerial device for a sufficient period of time to demonstrate proficiency in the actual operation of the aerial device.

11.5 Communications. In the event the manufacturer or installer provides the lessor manuals, bulletins, or other materials for the information of the user of an aerial device, the lessor shall pass them on to the user without delay.

11.6 Use of Brokers. If Brokers are employed in leasing, the responsibility of lessors and lessees as specified in this Section continue even though a Broker may be involved in the transaction.

12. RESPONSIBILITIES OF BROKERS.

12.1 Broker Involved In a Sale. A broker involved in a sale shall:

- (1) Assure that the entity actually transferring ownership knows the proper location and identification of proper of the purchasing entity.
- (2) Confirm that operations and maintenance manuals are provided to the new owner.
- (3) Confirm that all parties are aware of their responsibilities under Section 8.7 of this standard.

12.2 Broker Involved In a Lease. A broker involved in a lease shall:

- (1) Assure that the entity actually transferring possession know the proper location and identification of the proper personnel of the lessee or user of the aerial device.
- (2) Confirm that the operators' manual, maintenance manual, and Manual of Responsibilities are provided to the lessee.
- (3) Confirm that all parties are aware of their responsibilities under Section 11.4 of this standard.

SURVEY OF JOB SITE

Appendix (This Appendix is not part of American National Standard A92.2-2009 - but is included for information only.)

Construction and electrical workers are subject to certain hazards that cannot be eliminated by mechanical means and must be controlled by care, common sense and intelligence. Terex South Dakota, Inc. realizes the importance of safety and strongly recommends that prior to commencing any operation, the employer make a survey of the conditions of the site to determine the hazards and the kind and number of safeguards that the employer will install.

The survey should include, but not be limited to, the following:

- (1) Safe access and movement
 - (a) Work areas
 - (b) Walkways, runways and passageways
 - (c) Ladders, stairways and elevators
 - (d) Protection for floor and roof openings
 - (e) Illumination
- (2) Vehicles
 - (a) Roads
 - (1) Turn space
 - (2) Parking area
 - (3) Mud areas
 - (b) Materials storage areas and dump areas
 - (c) Signs and signals to route vehicles on the job
 - (d) Maintenance and repairs of vehicles
 - (3) Utilities and service
 - (a) Location of temporary buildings
 - (b) Location and identification of high-voltage lines (identify by signs; move, de-energize or erect barrier to prevent contact)
 - (c) Location of sanitary facilities and drinking water
 - (4) Scheduling work for safety
 - (a) Providing hard hats, life belts, goggles, work vests and the like on the job
 - (b) Establishing liaison among contractors to prevent congestion among trades
 - (c) Providing temporary flooring, safety nets and scaffolding where required
 - (5) Work Procedures
 - (a) Space
 - (b) Equipment such as cranes, hoists, elevators and trucks
 - (c) Rigging procedures
 - (d) Personal protective equipment
 - (6) Tools and equipment
 - (a) Repair, maintenance and care
 - (b) Inspection
 - (c) Supplies of tools for each job
 - (7) Workers and foremen
 - (a) Job assignment
 - (b) Training and supervision



- (c) Number of workers
- (d) Plans for maintaining interest in safety:
 - (1) Safety bulletins, record charts and posters
 - (2) Recognition for groups or individuals
 - (3) Investigation and reporting on reportable accidents
 - (4) Knowledge of safety orders
 - (5) Safety meetings
 - (6) Specific safety instructions for new employees
- (e) Establishment of provisions to take immediate action to correct unsafe conditions or acts
- (f) First aid and medical treatment of injuries