

TL Series

Table of Contents

Hi-Ranger TL Series
ARTICULATING AERIAL DEVICE

463109

OPERATOR'S MANUAL

This Operator's Manual **MUST BE READ** prior to operating your TL Series articulating Aerial Device.

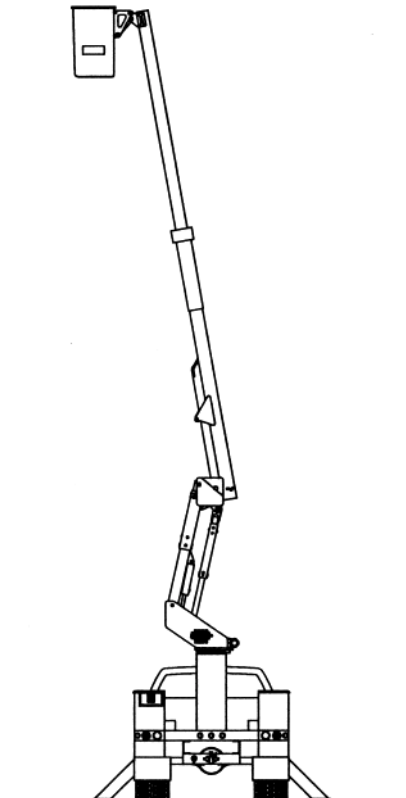

PRINTED IN THE USA



TEREX TELELECT
600 Oakwood Road
Watertown, SD 57201

Table of Contents

INTRODUCTION	- i
Owners, Users and Operators	- i
SAFETY GUIDELINES	- I
MAINTENANCE	- V
DECAL LOCATIONS	- IX
WHAT IS INSULATED AND WHAT IS NOT INSULATED	- X
Insulated Areas	- X
ELECTRICAL INSULATION	- XII
PREVENTION OF ELECTROCUTION	- XIII
OPERATION ON OR NEAR ENERGIZED CONDUCTOR	- XIII
OPERATION	1 - 1
NOMENCLATURE	1 - 1
OPERATOR CONTROLS & DESCRIPTIONS	1 - 2
UPPER CONTROLS - SINGLE STICK (OPTIONAL)	1 - 2
LOWER CONTROLS	1 - 4
CONTROLS BELOW ROTATION	1 - 5
OPERATION WITH LOSS OF CHASSIS POWER	1 - 5
PERSONNEL AND TRAINING	1 - 6
PRE-OPERATION	1 - 6
DAILY PRE-OPERATION CHECKS	1 - 6
PRE-OPERATIONAL PROCEDURES	1 - 7
Operating Temperature Range	1 - 7
SETTING THE OUTRIGGERS (IF SO EQUIPPED)	1 - 8
Setting Up for Operation on Snow and Ice	1 - 10
STABILITY	1 - 10
OPERATION	1 - 11
CAB CONTROL OPERATION	1 - 12
MASTER CONTROL	1 - 12
ENGINE STOP/START (OPTIONAL)	1 - 12
(PTO) POWER TAKE-OFF (IF SO EQUIPPED)	1 - 12
OUTRIGGER CONTROL OPERATION (OPTIONAL)	1 - 13
OUTRIGGER BOOM INTERLOCK (OPTIONAL)	1 - 13
HYDRAULIC TOOL OPERATION AT THE GROUND (OPTIONAL)	1 - 14
LOWER CONTROL OPERATION	1 - 14
HYDRAULIC PLATFORM LEVELING CONTROL (OPTIONAL)	1 - 15
ENGINE STOP/START CONTROL (OPTIONAL)	1 - 15
TWO-SPEED THROTTLE CONTROL (OPTIONAL FOR 5 GPM TOOLS)	1 - 15
AUXILIARY HYDRAULIC POWER CONTROL (OPTIONAL)	1 - 15
UPPER CONTROL OPERATION	1 - 16
SINGLE STICK CONTROL (STANDARD)	1 - 16
EMERGENCY STOP CONTROL (STANDARD)	1 - 16
HYDRAULIC PLATFORM ROTATOR (OPTIONAL)	1 - 16
HYDRAULIC PLATFORM LEVELING CONTROL (OPTIONAL)	1 - 16
TOOL POWER CONTROL LEVER (OPTIONAL)	1 - 17
AUXILIARY HYDRAULIC POWER CONTROL (OPTIONAL)	1 - 17
ENGINE STOP/START CONTROL (OPTIONAL)	1 - 17
TWO-SPEED THROTTLE CONTROL (OPTIONAL FOR 5GPM TOOLS)	1 - 17
MATERIAL HANDLING	1 - 18
EMERGENCY OPERATION	1 - 18



Table of Contents

CONTROL SELECTOR	1 - 18
MANUAL ROTATION	1 - 18
AUXILIARY HYDRAULIC POWER (OPTIONAL)	1 - 19
INJURED OR INCAPACITATED OPERATOR	1 - 19
HYDRAULIC LINE FAILURE	1 - 19
ENGINE FAILURE	1 - 20
HYDRAULIC PUMP FAILURE	1 - 20
CONTROL VALVE FAILURE	1 - 20
LEAVING THE JOB SITE	1 - 20
MAINTENANCE GUIDELINES	2 - 1
PREVENTATIVE MAINTENANCE	2 - 1
MAINTENANCE PROCEDURE	2 - 1
ADJUSTMENTS AND REPAIRS	2 - 1
LUBRICATION	2 - 2
OPERATIONAL CHECKLISTS	2 - 2
GENERAL INFORMATION	2 - 2
FREQUENT AND PERIODIC INSPECTION INTERVALS	2 - 3
DAILY	2 - 3
90 DAYS (360 HOURS)	2 - 3
180 DAYS (720 HOURS)	2 - 3
12 MONTHS (1,050 HOURS)	2 - 3
LUBRICATION CHART	2 - 4
STORAGE PROCEDURE	2 - 5
APPENDIX - A	A - 1
STANDARDS AND REGULATIONS	A - 1
STANDARDS AND REGULATIONS	A - 1
ANSI STANDARDS	A - 1
OSHA REGULATIONS	A - 1
OSHA EXCERPTS: (CLEARANCE DISTANCE)	A - 2
STANDARD HAND SIGNALS	A - 4
APPENDIX - B	B - 1
ANSI A92.2-2001	B - 1

INTRODUCTION

Owners, Users and Operators

Thank you for choosing TEREX TELELECT equipment for your application. User safety is our number one priority and this is best achieved by our joint efforts.

As equipment users and operators, you make a major contribution to safety if you:

1. Comply with OSHA, federal, state, ANSI, local and company regulations.
2. Read, understand and follow the instructions in this manual and other manuals supplied with this vehicle.
3. Only allow trained operators, directed by informed and knowledgeable supervision, to run the vehicle.

If there is anything in this manual that is not clear or you believe should be added, please send your comments to:

Manager of Publications
TEREX TELELECT
600 Oakwood Road
Watertown, South Dakota 57201

You may also contact us by phone at: (605) 882-4000



This Symbol means your safety is involved! - Read, understand and follow all danger, warning and caution decals and instructions on your Aerial Device and in this manual.

This manual contains important information on the safe use of your TEREX TELELECT equipment. Your failure to read, understand and follow all safety rules, warnings and instructions will unnecessarily expose you and others to dangerous situations. For your safety and the safety of those around you, you **must** operate your TEREX TELELECT equipment as instructed in this manual.



The operator is the single most important factor for safety when using any piece of equipment. Learn to operate your TEREX TELELECT equipment in a safe manner.

The following signals are included to help you recognize important safety information. They identify **warnings** and **instructions** that directly impact on safety.



Danger: Indicates an imminently hazardous situation, which if not avoided, will result in death or serious injury.



Warning: Indicates a potentially hazardous situation, which if not avoided, could result in death or serious injury.



Caution: Indicates a potentially hazardous situation, which if not avoided, may result in minor or moderate injury.



Caution: Used without the safety alert symbol indicates a situation, which if not avoided, may result in property damage.

NOTE: The best method to protect yourself and others from injury or death is to use common sense. If you are unsure of any operation, do not continue until you are satisfied that it is safe to proceed.



In addition to maintenance and operating instructions in this manual, the operator must read and understand all the instructions in the following safety guidelines.

1. Study all safety messages. Remember and apply them on the job.
2. Modifications to this TEREX TELELECT equipment from the original design specifications without written permission from TEREX TELELECT are strictly forbidden. A modification may compromise the safety of the TEREX TELELECT equipment, subjecting users to serious injury or death. Any such modification will void any remaining warranty.
3. TEREX TELELECT reserves the right to change, improve, modify or expand features of its equipment at any time. Specifications, model or equipment are subject to change without notice and without incurring any obligations to change, improve, modify or expand features of previously delivered equipment.
4. Comply with manufacturer's instructions and requirements of current OSHA regulations and ANSI standards.

SAFETY GUIDLINES**General Safety Guidelines**

1. The use of this Aerial Device is subject to certain potential dangers that cannot be protected against by mechanical means. Only the exercise of intelligence, care, and common sense can eliminate these dangers. It is essential to have competent, careful operators who are physically and mentally fit, and thoroughly trained in the safe operation of this Aerial Device. Learn, understand and practice safe use of all equipment and controls - before operating this Aerial Device.
2. Never exceed the rated load capacity of the platform. Know the total weight - including the operator, platform liner, tools, and equipment, and/or other items before entering platform.
3. Do not operate this Aerial Device if any interlock or safety device is malfunctioning.
4. Do not bypass or remove any interlock or safety device.
5. Never operate with damaged leveling chain or components.
6. Never operate from the ground controls with personnel in the platform. Operation must be controlled by the platform operator, except in case of an emergency.
7. Keep the vehicle areas free of obstructions that may interfere with the controls or personnel who may have to operate them in an emergency.
8. Stop in position if you become aware of any dangerous conditions or hear any unusual noise (such as grinding, cracking or grating) while operating the Aerial Device. Do not move the Aerial Device until the problem has been resolved.
9. Be sure all ground personnel know the proper procedure to follow in case of an emergency.
10. Do not operate the Aerial Device in an electrical storm.
11. The hydraulic fluid is petroleum based and will burn.

**Before Operation**

1. Survey the conditions of the work area. Identify situations such as: soft ground, ditches, drop-offs, holes, debris, overhead obstructions, electrical conductors and underground utilities.
2. Plan the job (tailgate session) and clear the area of bystanders.
3. Set the vehicle parking-brake and chock the wheels.
4. Make certain tire pressures are proper for operation.
5. Visually inspect the condition of all torsion bars for any damage.
6. The vehicle must be securely parked and stabilized before any operation is performed. Do not operate on ice as slippage may occur.
7. Do not lower outriggers unless you can see that all ground personnel and bystanders are clear of the outrigger's movement path and ground contact point. Lower the outrigger onto solid footing.
8. Ground and/or barricade the vehicle.
9. Perform controls inspection before beginning operation. Do not operate with malfunctioning controls.
10. This Aerial Device has been tested per the stability requirements of ANSI A92.2 and may be operated on firm, non-level surfaces up to a 5° slope.
11. Barricade any overhead electrical lines that may be a potential contact during operation.
12. Inspect and maintain personal protective equipment.



**During Operation**

1. Never operate the Aerial Device unless you know the location, function, and operation of all the controls, including emergency and accessory operation.
2. Avoid abrupt starts, stops and reversal of direction. Operate all controls slowly for smooth motion.
3. Keep hands off all moving parts to avoid injury.
4. Operator(s) must wear an OSHA approved fall protection system with a lanyard attached to an anchor provided.
5. Wear personal protective equipment such as: Insulated hard hat, rubber gloves with leather protectors and rubber sleeves. Hearing & eye protection, proper boots and suitable clothing may also be required.
6. Do not place the boom or platform in open traffic lanes without first stopping or barricading lanes to divert traffic from area.
7. Do not allow boom or platform to contact fixed objects.
8. Do not tie off to an adjacent structure, pole, or other equipment.
9. Never exceed rated capacity of platform.
10. Do not use the platform for lifting material, the platform is designed for lifting personnel only.
11. Do not pass tools, equipment, or other objects between the occupant of the platform and other personnel on poles or other platforms.
12. Do not sit or climb onto edge of platform or use planks, ladders, or other devices for a work position. Always stand with both feet on floor of the platform.
13. Do not wear climbers while in the platform.
14. Use of the platform for material lifting shall be avoided. The platform was designed for lifting personnel only.
15. Do not allow ground personnel under the platform work area.
16. Do not operate with platform leveling malfunctioning.
17. Do not move the vehicle with personnel in the platform.
18. Do not allow ground personnel to be in contact with vehicle or attached apparatus.
19. Never use your bare hands (wear rubber gloves) on grounded conductors when energized conductors are on the same structure.
20. Never tie loads to the platform or booms. Always use lifting attachment when it is necessary to lift or lower an object.
21. Do not lift loads with the Aerial Device if it is not equipped with a lifting attachment.
22. High speed should only be used when moving the platform to an aerial job site. Low speed should be used to move into or within the aerial job site.
23. Low engine speed should be used when an extended period of time is going to be spent at an aerial job site.



Electrical Dangers

Electricity obeys no law, but its own.

1. Electricity is an ever-present danger when using an Aerial Device. Follow all OSHA, ANSI, state, federal, and company rules and regulations when working on or near energized power lines.
2. Always maintain proper clearance from energized power lines. This Aerial Device cannot protect you from phase-to-phase or phase-to-ground contact, which occurs above the insulated boom section.
 - Allow for platform sag, sway or rocking.
 - If any part of boom-tip contacts an energized conductor, the entire boom-tip, including the control handle(s), must be considered energized.
 - If any part of the boom-tip contacts a grounded object, the entire boom-tip, including the control handle(s), must be considered grounded.
3. The booms and boom operators shall be properly insulated from any contact with electrical conductors; including neutral or ground lines, poles, cross arms and guy wires. Utilize proper insulation such as line covers, rubber blankets and hot line tools.
4. Never place booms, platforms or personnel between energized conductors or between an energized conductor and a grounded conductor.
5. Do not wear clothing that when exposed to flames or electricity could increase the extent of injury.
6. Never operate the Aerial Device in an electrical environment if the fiberglass components are damaged, contaminated by moisture or dirt or otherwise maintained improperly. At a minimum, a daily inspection and an annual dielectric testing of all fiberglass components is necessary to maintain the integrity of the insulation.
7. Never allow ground personnel to come in contact with the Aerial Device, vehicle or vehicle attachments while in operation near energized power lines.
8. When working on or near energized power lines or equipment, the vehicle must be grounded and/or barricaded and considered as energized.
9. Never rely on the fiberglass platform insulation when in the platform. It may contain small unseen cracks that will allow an electrical path into the platform. Always use a platform liner.
10. Never touch the controls or boom-tip area when in the platform without using proper protection (wear rubber gloves), while holding any conductors, neutrals, grounds, or other structures.
11. Treat ground and neutral conductors as energized (wear rubber gloves).
12. Wear rubber gloves when handling duplex and triplex wire.
13. All tools, accessories and other objects must be contained within the platform when working on or near energized power lines.
14. Check the boom-tip area for any exposed conductive material and do not allow boom-tip to come in contact with an energized phase or ground.
15. Do not carry or allow a conductor to touch your body. Wear rubber gloves when handling conductors, even if the conductors are grounded.
16. All metal components at the boom-tip beyond the band of arrows are interconnected. Contact of any part to an energized conductor will energize the entire boom-tip, including the controls.
17. Do not attach any metal objects from outside the platform to the inside of the platform. This defeats the purpose of the platform liner.
18. Do not hang metal objects from the platform. It increases the chances of an accidental contact.
19. Use only non-metallic tool holders and tool trays.



**Accessories**

1. When working from the platform, always use tools equipped with orange hoses marked NON-CONDUCTIVE. The hoses must be kept clean and dry and inspected for damage.
2. All accessories must be inspected, maintained and operated with the same care and safety rules that apply to the Aerial Device.
3. Do not use hoses having less than 2750 psi working pressure ratings.
4. Tools selected for use with this Aerial Device should be open-center type and operate satisfactorily at 2000 psi and 5 GPM.
5. If this Aerial Device is equipped with a lower-boom lifting-eye, the boom position and lifting capacity must not be exceeded.
6. Personnel or load shall not be allowed in the platform when utilizing the lower-boom lifting-eye.
7. Do not place booms or platform under trees or limbs while trimming to avoid possible damage or overloading.
8. Do not operate hydraulic hand tools continuously, especially on high speed, for an extended period of time without stopping. Continuous operation can cause overheating and possible damage to the hydraulic system.

**Traveling**

1. Never travel with personnel in the platform.
2. Never travel with the booms raised.
3. Store booms properly in the boom rest. Fully lower the lower boom before stowing the main boom.
4. Lock upper boom in place with hold-down strap.
5. Keep all tools or other items properly stored on the vehicle while traveling. Otherwise, they may fall onto the roadway.
6. Fully retract the outriggers, store outrigger pads and wheel chocks.
7. Disengage the power take-off to prevent damage.
8. Follow the vehicle manufacturer's instructions for operating the vehicle.

TL Series

Table of Contents**Maintenance**

1. Inspect, maintain and repair this Aerial Device in accordance with the maintenance manual for this device and the maintenance section of this manual.
2. Only authorized and skilled personnel with complete knowledge of this Aerial Device shall be allowed to perform maintenance on this Aerial Device.
3. Never drill holes in the platform.
4. Replace all illegible decals.
5. Do not alter the insulated portion of this Aerial Device. Altering this Aerial Device in any way could reduce its insulating value.
6. Do not search for leaks with your hands or any other part of your body.
7. All hoses must meet or exceed the working pressure as stated in the maintenance manual.
8. Only use orange hoses marked NON-CONDUCTIVE for tool hoses at the boom-tip and areas that bridge the insulation gap.
9. Do not use replacement components that are not equal to the original components.
10. Use OSHA lockout/tagout procedure to prevent operation during inspection and repair.
11. Before doing any work on the hydraulic system, secure the booms and outriggers. Release hydraulic pressure before attempting any repairs or disassembly of hoses, valves, cylinders or any other hydraulic components.



Safety-Related Decals

⚠ DANGER

**AN UNTRAINED OPERATOR
SUBJECTS HIMSELF AND
OTHERS TO
DEATH OR SERIOUS INJURY
YOU MUST NOT OPERATE
THIS MACHINE UNLESS**

- You have been trained in the safe operation of this machine.
- You have read, understand and follow the safety and operating recommendations contained in the machine manufacturer's manuals, safety signs attached to equipment, your employer's work rules and applicable government regulations.
- You are sure the machine is operating properly and has been inspected and maintained in accordance with manufacturer's manuals.
- You are sure that all safety signs, guards and other safety features are in place and in proper condition.

419267

⚠ DANGER

**ELECTROCUTION HAZARD
THIS MACHINE IS
NOT INSULATED**

DEATH OR SERIOUS INJURY
Will result from contact with or inadequate clearance to electrical power lines and apparatus

- Maintain safe clearance from electrical power lines in accordance with applicable government regulations. Allow for boom, platform, electrical line and load line sway.
- This machine does not provide protection from contact with or proximity to an electrically charged power line.
- Boom and platform must be kept below all electric power lines.
- Do not use for work on electric power lines.

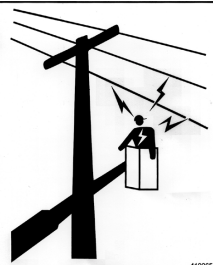

419265A

⚠ DANGER

ELECTROCUTION HAZARD

DEATH OR SERIOUS INJURY
WILL RESULT FROM CONTACT WITH THIS MACHINE, TRUCK OR TRUCK ATTACHMENTS IF THEY SHOULD BECOME ELECTRICALLY CHARGED.

KEEP CLEAR OF TRUCK AND LOAD

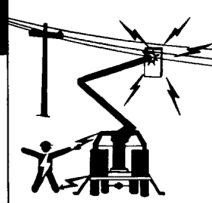

419266

⚠ DANGER

**ELECTROCUTION HAZARD
FIRE HAZARD**

USE ONLY ORANGE, NON-CONDUCTIVE HOSE FOR TOOL, PLATFORM AREA, AND INSULATED SECTIONS.

**FAILURE TO DO SO MAY CAUSE
DEATH OR SERIOUS INJURY.**



419270A

⚠ DANGER

**FAILURE TO OBEY THE FOLLOWING
WILL RESULT IN
DEATH OR SERIOUS INJURY**

- For stationary operation, truck must be securely parked, driveline disengaged, and Aerial Device properly stabilized prior to operation.
- To avoid tip-over, outriggers (when so equipped) must be properly extended on a solid level surface.
- Operate all controls slowly for a smooth platform motion and make sure controls are returned to neutral after desired operation.
- Crew must use proper personal and other protective equipment.
- Never load beyond rated capacity.
- Never operate Aerial Device with personnel under boom or load.
- Never move the truck until the booms and outriggers are in a properly stowed position and secured.
- Refer to the operator's manual for complete instructions. If missing, replace manual.

419262

⚠ DANGER

**FALLING FROM PLATFORM
WILL RESULT IN
DEATH OR SERIOUS INJURY**

- Platform personnel must wear an OSHA approved fall protection system with lanyard attached to anchor provided.
- Platform doors, if provided, must be securely latched.



419264

⚠ DANGER



**OUTRIGGER CONTACT WILL CAUSE
SERIOUS CRUSHING INJURY
STAND CLEAR**

419288

⚠ DANGER

**OUTRIGGER CONTACT
WILL CAUSE
SERIOUS CRUSHING INJURY**

- Do not operate any outrigger unless you or a signal person can see that personnel and obstructions are clear of the outrigger and its contact point.

419288

⚠ WARNING



Escaping fluid under pressure can penetrate skin causing serious injury.

Relieve pressure before disconnecting hydraulic lines. Keep away from leaks and pin holes. Use a piece of cardboard or paper to search for leaks. Do not use your hand.

Fluid injected into skin must be surgically removed within a few hours by a doctor familiar with this type injury or gangrene will result.

⚠ DANGER

READ CAREFULLY

- OCCUPANTS OF THE BASKETS OF THIS AERIAL DEVICE HAVE ABSOLUTELY NO ELECTRICAL PROTECTION FROM CONTACT BY THE HUMAN BODY WITH TWO ENERGIZED CONDUCTORS OR BETWEEN AN ENERGIZED CONDUCTOR AND A GROUNDED CONDUCTOR.
- It makes no difference if this contact is accidental or deliberate or whether contact is made through metallic parts of the basket, basket support, metal tools or equipment brought into the basket. The insulating components of this aerial device do not offer protection in the event of such contact.
- Proper conductor cover up, insulated sleeves and gloves shall be worn when working near energized lines or equipment.

**DEATH OR SERIOUS INJURY
WILL RESULT FROM SUCH CONTACT
OR INADEQUATE CLEARANCE**

414590A

⚠ WARNING

**PINCH POINT
KEEP HANDS CLEAR
TO AVOID PERSONAL INJURY**

H23451

⚠ DANGER

ELECTROCUTION HAZARD

**DEATH OR SERIOUS INJURY
WILL RESULT FROM CONTACT WITH
OR INADEQUATE CLEARANCE TO
ELECTRICAL POWER LINES
AND APPARATUS**

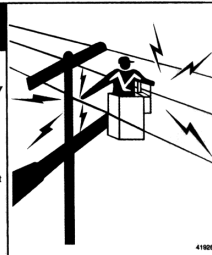

- Maintain safe clearances from electrical power lines in accordance with applicable government regulations. Allow for boom, platform, electrical line and load line sway.
- This machine does not provide protection from contact with or proximity to an electrically charged power line when you are in contact with or in proximity to another power line.

419283



Table of Contents

⚠ DANGER

**BOOM IS NOT INSULATED
BEYOND ARROWS**

AVOID CONTACT WITH ENERGIZED LINES.

402236A

⚠ DANGER

**ELECTROCUTION HAZARD
CONTROLS ARE NOT INSULATED OR ISOLATED**

All metal at boom tip is electrically connected. Operator contact with ANY, live or grounded, line or object while operator touches CONTROLS or BOOM TIP components and boom tip contacts any other line or object can result in **DEATH OR SERIOUS INJURY.**

- Maintain proper CLEARANCE to all lines and objects
- Wear Personal Protective Equipment, insulating gloves, sleeves, and hard hat
- Cover all lines with insulated line hose or insulating blankets
- DO NOT Depend on machine covers for insulation. Plastic or fiberglass covers offer limited electrical insulation. Covers are NOT tested, certified, or maintained as insulating.

APROWS
BOOM TIP
(ALL PARTS PAST ARROWS)

463902

⚠ WARNING

**FAILURE TO FOLLOW
PROPER PROCEDURES**

**Could Result In
DEATH OR SERIOUS INJURY**

If YOU sell, install, offer for use, use operate or maintain this Aerial Device

You MUST COMPLY with the requirements of: American National Standards Institute A92.2 National Electric Safety Code, and OSHA

468476



MINIMUM EXTENSION

79691

⚠ DANGER

**ELECTROCUTION
HAZARD**

BOOM MUST BE EXTENDED SO MINIMUM EXTENSION DECAL IS BEYOND OUTER BOOM SECTION WHEN OPERATING IN OR NEAR ENERGIZED CONDUCTORS

DEATH OR SERIOUS INJURY

WILL RESULT FROM CONTACT WITH ENERGIZED CONDUCTORS WITH INADEQUATE BOOM EXTENSION

79238C

Table of Contents

Decal Locations



Operating this equipment without all safety and control decals in place can be hazardous.

If any of these items are illegible or missing, replace them immediately.

NOTE: Use decal 419265 when unit is not certified in accordance with latest ANSI A92.2 revision or booms are not insulated.

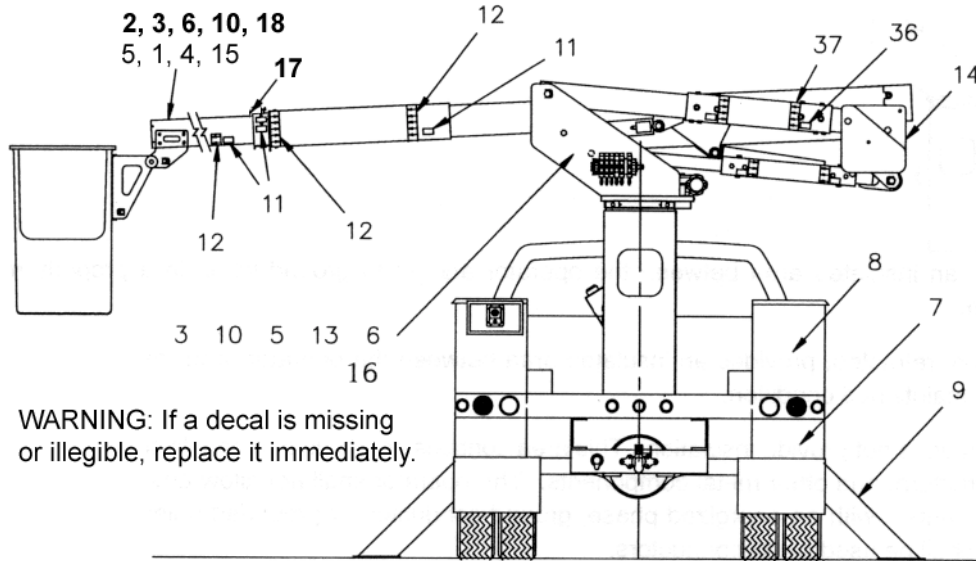

ITEM #	DECALS	QTY.	PART #
1	CONDUCTIVE HOSE	1	419270
2	FALLING FROM PLATFORM	1	419264
3	UNTRAINED OPERATOR	2	419267
4	ELECTROCUTION HAZZARD	2	419265
5	ELECTROCUTION HAZZARD	2	419263
6	FAILURE TO OBEY THE FOLLOWING	2	419262
7	OUTRIGGER - CRUSHING - DO NOT OPERATE	2	419268
8	ELECTROCUTION HAZZARD	3	419266
9	OUTRIGGER - CRUSHING - STAND CLEAR	2	419269
10	READ CAREFULLY	2	414590
11	BOOM NOT INSULATED BEYOND ARROWS	8	402236
12	ARROWS	24"	402237
13	ESCAPING FLUID UNDER PRESSURE	1	H23877
14	WARNING PINCH POINT	2	H23451
15.	CONTROLS NOT INSULATED	1	463602
16.	ANSI WARNING	1	468476
17.	MINIMUM EXTENSION	2	79691
18.	EXTEND TO MINIMUM EXTENSION	1	79238



What is Insulated and What is Not Insulated



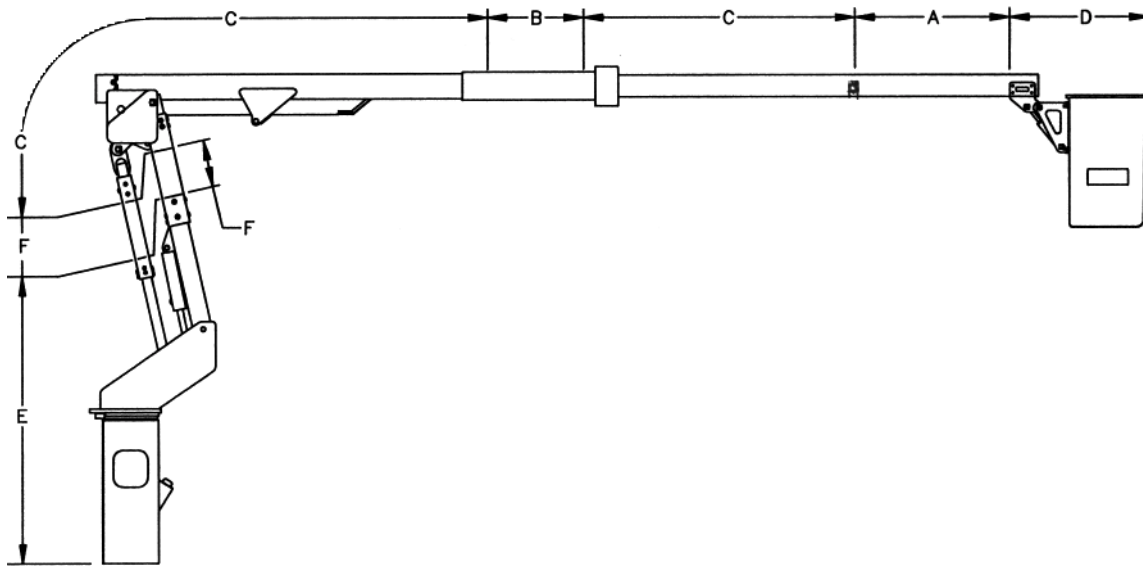



The term insulated means separated from other conductive surfaces by a dielectric substance (including air space) offering a high resistance to the passage of current (from OSHA 1926.960).

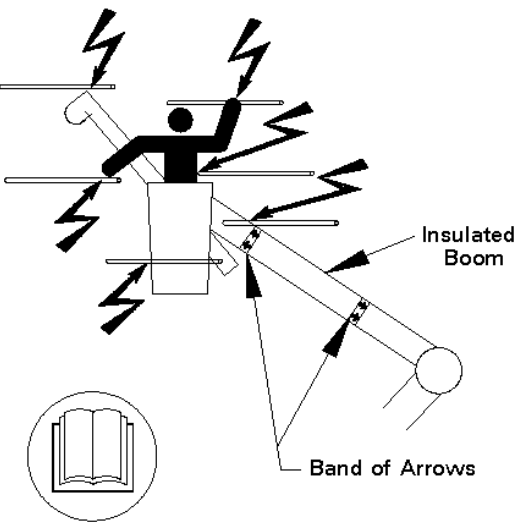

Insulated Areas

- A. Area A, upper boom insulating section, provides an insulated area between area D and earth ground when in properly maintained condition.
- B. Area B, lower boom insulating section, provides an insulated area between area C and the vehicle when in properly maintained condition.
- C. Area C, elbow, does not provide insulation. This area contains conductive materials such as cylinders, pins, boom structure, and other metal components. The operator shall not allow any portion of this area to come in contact with an energized phase, ground conductor, or grounded objects. Proper protective devices shall be used on all conductors. Any contact with a ground and a phase or between two-phase conductors will create a hazard.
- D. Area D, boom tip, does not provide insulation. This area contains conductive materials such as control levers, un-insulated platform(s), platform support shaft, boom tip structure, and other metal components. These objects must be considered connected. The operator shall not allow any portion of this area to come in contact with an energized phase, ground conductor, or grounded objects. Proper protective devices shall be used on all conductors. The operator shall not make contact with any portion of this area when working on or near an energized phase, ground, or grounded objects, unless wearing proper protective clothing such as rubber gloves and sleeves rated at the voltage of the lines. Any contact with a ground and a phase or between two-phase conductors will create a hazard. Accidental contact of any portion of area D to an energized conductor will energize the entire area D.
- E. Area E does not provide insulation. This area contains conductive materials such as cylinders, pins, boom structure, turntable, pedestal, and other metal components. The operator shall not allow any portion of this area to come in contact with an energized phase, ground, or grounded objects. Proper protective devices shall be used on all conductors. This area is attached to the vehicle that shall be grounded through an approved ground system when working in the vicinity of energized conductors. Any contact with a phase or between two-phase conductors will create a hazard.

NOTE: A platform liner, properly maintained will provide only for those portions of the body or materials entirely within the liner and not in contact with any part of area D.

	<p> The insulated boom section only prevents current from passing from the band of arrows at the boom tip to the lower band of arrows. All components above and below that point must be considered conductive.</p> <p> The boom tip is everything past the upper band of arrows. All boom tip components are structurally and electrically connected. Contact with any part of the boom tip will energize the entire boom tip including controls, jib, winch and platform support structure.</p> <p> Death or serious injury to the operator or ground personnel can occur if any part of the boom contacts an energized conductor, ground line, grounded line, or OBJECTS. Proper clearance must be maintained.</p> <p> You must always cover the line and wear rubber gloves with rubber sleeves, and an approved hard hat when any part of the machine is working in or near energized lines or conductors even when working on a grounded line, neutral line, or ground line.</p> <p> You must read the operators manual to fully understand the protection the machine will give you.</p>
---	---

 Anytime the platform occupant(s) contact two items at different potential with out proper personnel protective equipment, his body may become a path for electric current and he may be electrocuted. This includes touching the controls, any tools or items on the boom tip while also contacting a line or ground.



Electrical Insulation

The operation of this Aerial Device in proximity to high voltage electrical lines involves several hazards to the operator of the Aerial Device, ground personnel and bystanders on the ground. These hazards are as follows:

1. Unless the operator is insulated from the ground, any contact between the operator and a single energized line will allow current to pass through the operator's body to the ground by means of an all-metal boom structure.
2. Electrocutation will occur if the operator gets in contact with two energized lines or one energized line and a grounded conductor, even if the operator is insulated from the ground by the Aerial Device.



The fiberglass upper boom, fiberglass lower boom insert and fiberglass platform, including its components, do not protect the platform operator from injury in case of contact between two energized lines, or between an energized line and a grounded conductor.



Working around electrical power lines is covered by ANSI and OSHA Regulations. To reduce danger to the operator and ground personnel or bystanders on the ground, understand and follow all rules.

IMPORTANT: Only caution on the part of the occupant(s) will protect the upper half of their body from Hazard No. 2.

3. Contact of a metal section of the boom with a wire, below the insulation of the boom, will energize the Aerial Device and the vehicle causing shock to ground personnel and bystanders standing on the ground and touching the unit.



Ground personnel should never touch the Aerial Device, the vehicle or an attached trailer while the Aerial Device is in operation near electrical power lines even though the Aerial Device has an insulated boom and lower boom insert.



Avoid contact of any metal part or equipment below the insulated section of the lower boom with an electrical power line. Serious injury or death could result.

4. Contact of the boom with a wire may burn the wire in two, which will cause a hazard to ground personnel and bystanders below.

Some protection against Hazard No.1 is furnished by the fiberglass upper boom. When PROPERLY MAINTAINED, the insulated boom protects platform personnel in case they were to contact a SINGLE energized power line within the qualification voltage limit stamped on the nameplate. However, this protection can be nullified by accumulation of dirt and moisture on or in the boom. Operator safety requires a regular electrical testing program.

Some protection against inter-phase contact, Hazard No. 2, is offered by the fiberglass platform and the optional platform liner. However, insulation strength of the platform wall is subject to deterioration due to crazing of the fiberglass from flexure or abuse. Therefore, the standard platform liner is used for inter-phase protection of the lower half of the body. Only caution on the part of the platform personnel and use of proper protective equipment will protect the upper half of their body from this hazard.

Limited protection of ground personnel against contact of the steel elbow area or lower boom with an energized line, Hazard No. 3, is offered by the insulated lower boom and a proper grounding system. The lower boom insert, like the insulated upper boom, must be regularly tested and cleaned to ensure continued safety. Contact with an energized line below the lower boom insert will energize the vehicle and the ground around the vehicle. Anyone close to the vehicle may be injured. Only a ground cable to a suitable ground will prevent damage and injury.

There is no protection against Hazard No. 4. Caution must be exercised continually to avoid making contact with an energized line, which, if burned, may drop to the ground and cause injury to ground personnel and any bystanders.

Ensure ground cables are making good contact with the vehicle and ground rod or neutral.

TL Series

Table of Contents**Prevention of Electrocutation**

1. NEVER rely on fiberglass dielectric properties around power lines with moisture present on the platform(s) and booms. If the unit is stored outdoors, protect the platform(s) and booms from the weather with a cover when not in use. To preserve dielectric properties, fiberglass must be kept clean and dry.
2. REMEMBER, auxiliary equipment (such as electrical cords, communication lines, and conductive tools) bridge the insulation between the operator and ground, rendering the insulation useless.
3. REMEMBER, your equipment cannot protect you against contact between two-phase or one phase and a pole or a grounded conductor. Never work between electrical lines unless the proper precautions are observed.
4. DO NOT allow any ground personnel or bystanders to touch the Aerial Device, the vehicle or an attached trailer while the Aerial Device is in operation near electrical power lines, even if the Aerial Device has an insulated lower boom.
5. Have insulation TESTED annually in accordance with established rules and regulations.
6. CONTROLS are not insulated and are interconnected to all other conductive components at the boom-tip. Do not contact any conductor or wire while touching Controls.

Operation On or Near Energized Conductor

When working ON OR NEAR ENERGIZED CONDUCTORS (either known or suspected), special conditions arise. While the fiberglass upper boom provides a high degree of electrical insulation between the platform and the vehicle, there are several things it WILL NOT DO:

- IT WILL NOT PROVIDE PHASE TO PHASE PROTECTION.
- IT WILL NOT PROVIDE PHASE TO GROUND PROTECTION THROUGH STATIC LINES OR GUY WIRES.
- IT WILL NOT PROTECT THE VEHICLE FROM BEING ENERGIZED IF STEEL BOOMS CONTACT A LOWER LEVEL SECONDARY POWER SOURCE.

The fiberglass boom must be kept clean and dry for this type of work.

	<p>The fiberglass boom and platform liners must be dielectrically tested periodically to insure the insulating properties are being maintained.</p> <p>Do not assume that it is so.</p>
	<p>Ground personnel must be warned to stay away from vehicle in case of accidental boom contact between conductor and metallic portion of boom, which will cause serious injury or death.</p>



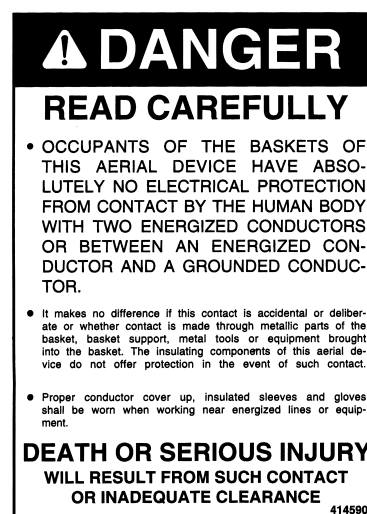
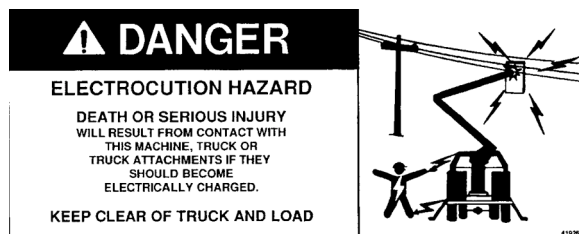

	<p>Upper Controls can become energized if any part of the boom-tip past the band of arrows on the boom contacts a conductor. The Aerial Device upper control station has metal parts that are necessary to provide the structural support for the components. These metal parts at the boom-tip are interconnected. The main shaft that supports the platforms and controls also support other load carrying options that can be added to the boom-tip.</p>
	<p>Do not depend on machine covers for insulation. Plastic or fiberglass covers offer limited electrical insulation. Covers are not tested, certified or maintained as insulation.</p>
	<p>The fiberglass upper and lower boom, in a well maintained condition, provides electrical insulation between the upper boom-tip and the vehicle to ground. This fiberglass will not protect the platform operator if any portion of the upper arm control station, including options is brought into contact with an energized or non-energized conductor and the operator is in contact with a different potential, such as grounded non-energized conductor. This type of contact can energize or ground the controls because all components of the upper control station are interconnected. The fiberglass will not provide protection for the operator in phase to phase contact or a phase to ground wire contact, nor will it protect the vehicle from becoming energized if the steel boom section below the lower boom insert, if so equipped, is brought into contact with an energized conductor. Serious injury or death could result.</p>

**SECTION 1:
OPERATION**

NOMENCLATURE

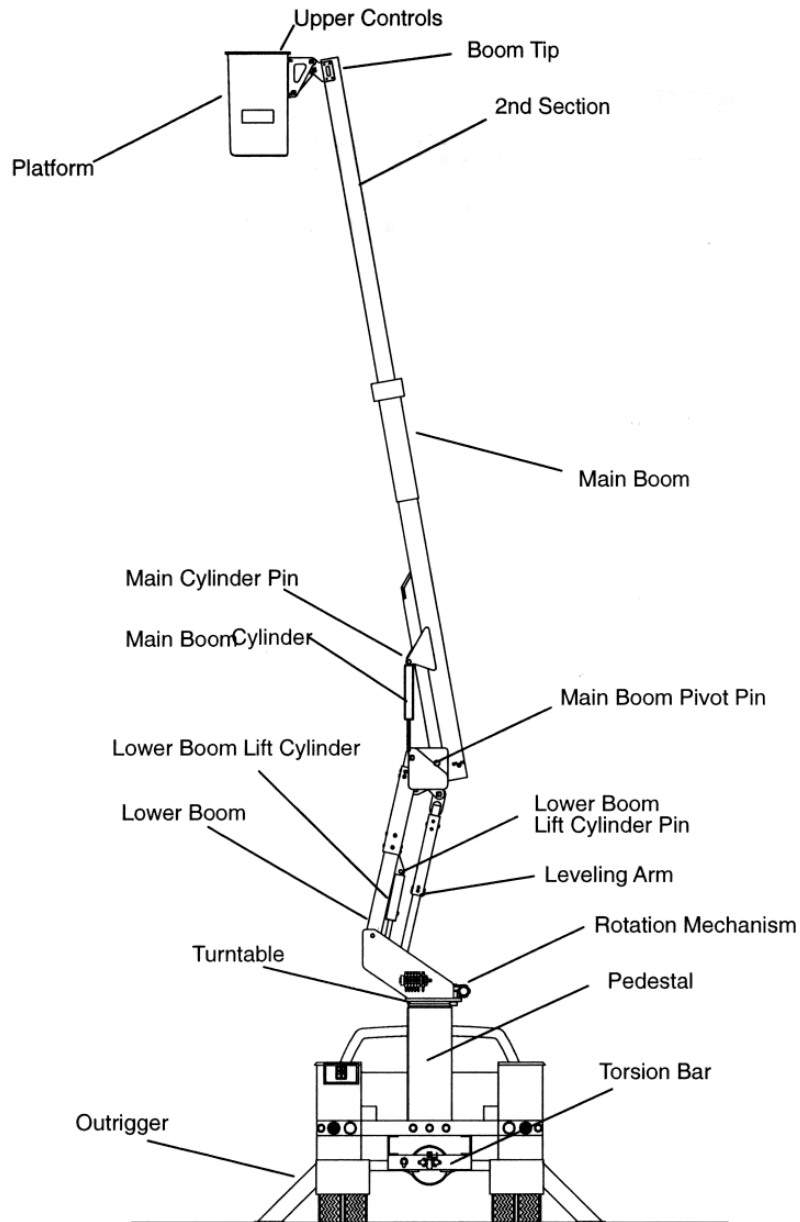

OPERATOR CONTROLS & DESCRIPTIONS

UPPER CONTROLS - SINGLE STICK (OPTIONAL)

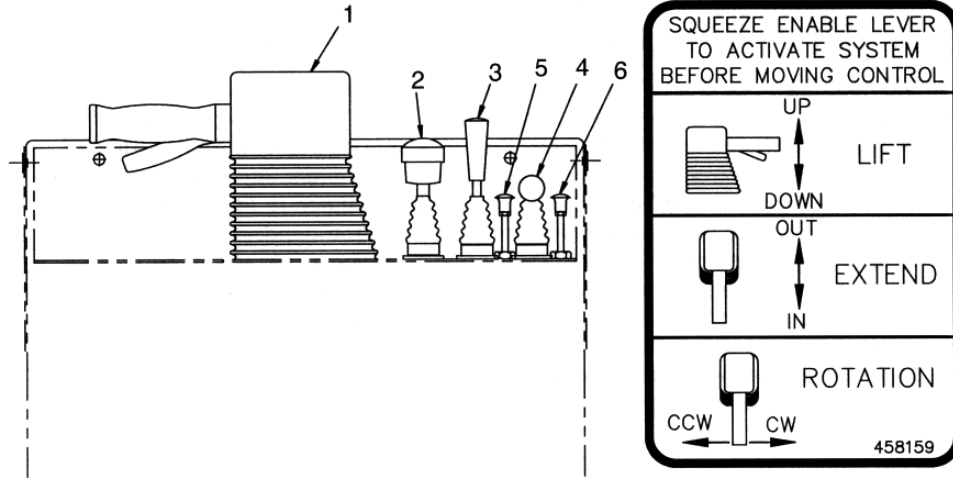

Item	Control	Description
1.	Single Stick	Controls main boom lift, rotation, and boom extension.
2.	Lower Lift	Controls lower boom lift.
3.	Auxiliary Tools Power (ATP)	Controls oil flow to auxiliary tools.
4.	Emergency Stop	Diverts the oil to the tank to stop operation of platform controls.
5.	Engine Stop/Start	Allows the operator to stop and start the engine from the platform.
6.	Two-Speed Throttle (Optional) & Auxiliary Power (Optional)	Two-Speed Throttle provides two engine speeds, low and high, with engine running. Low speed is engine idle. Auxiliary Power provides hydraulic power to lower and stow the Aerial Device in the event of a prime power source failure.

Table of Contents



The Aerial Device upper control station has metallic parts which are necessary to provide the structural support for the various components. These metallic parts are interconnected. The main shaft that supports the platforms and controls must also support other load carrying options that can be added to the boom tip.

The fiberglass upper and lower boom, in a well maintained condition, provides electrical insulation between the upper boom tip and the truck as a ground. This fiberglass will not protect the operator in the platform if any portion of the upper arm control station, including options, is brought into contact with an energized or non-energized conductor and the operator is in contact with a different potential, such as, a grounded non-energized conductor. This type of contact can energize or ground the controls because, as stated before, all components of the upper control station are inter-connected. The fiberglass will not provide protection for the operator in phase to phase contact or a phase to ground contact, nor will it protect the vehicle from becoming energized if the steel boom section below the lower boom insert, if so equipped, is brought into contact with an energized conductor.

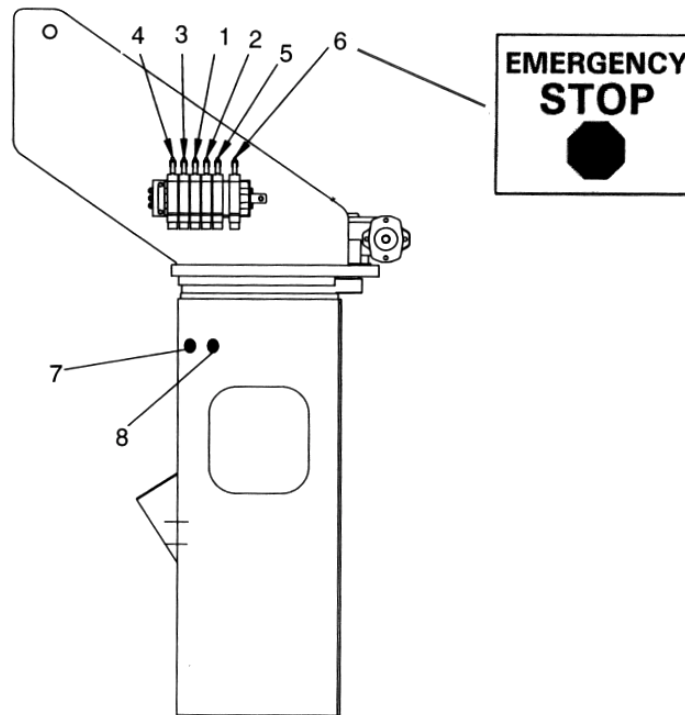

LOWER CONTROLS



Item	Control	Description
1.	Rotate	Controls rotation of main boom.
2.	Extend	Controls extension of the boom second section.
3.	Upper Lift	Controls main boom lift.
4.	Lower Lift	Controls lower boom lift.
5.	Tilt/Level	Controls platform leveling. Allows the platform to be tilted for clean-out or rescue.
6.	Control Selector 	Selects platform or lower controls operation  The control selector will function as an emergency stop by taking oil flow away from the active controls.
7.	Engine Start/Stop	Controls stop and start of the engine from the pedestal.
8.	Two-Speed Throttle (Optional) Auxiliary Power (Optional)	Provides two engine speeds, low and high; low speed is engine idle. Provides hydraulic power to lower and stow the Aerial device in the event of a prime power source failure.

NOTE: The decals are an integral part of this machine. If the decals are illegible, they must be replaced.

Table of Contents

NOTE: Always operate controls slowly and deliberately for smooth, safe platform movements. Rough handling is never excusable and may cause damage to the unit and endanger the operator.

CONTROLS BELOW ROTATION

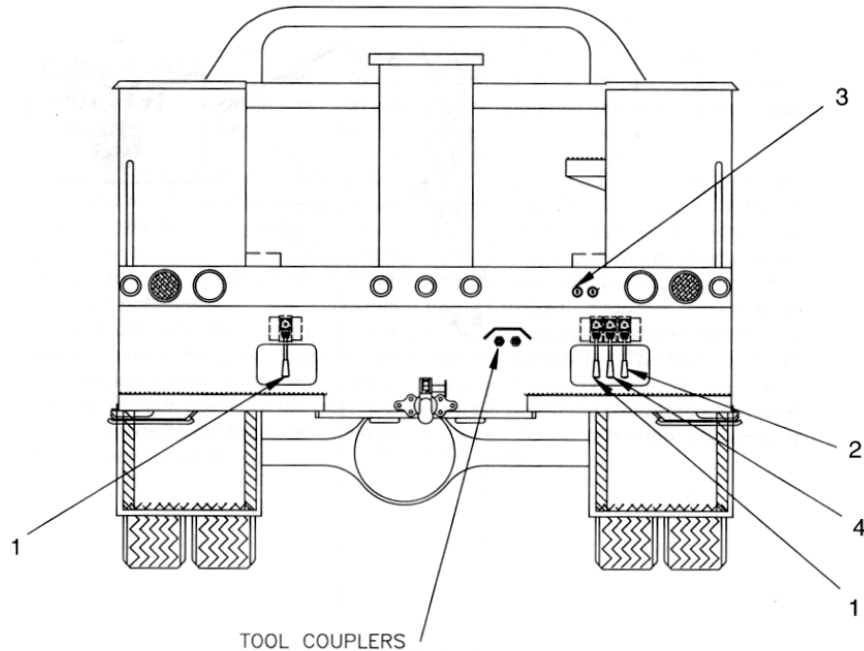

Item	Control	Description
1.	Outrigger Controls (Optional)	Allows extending and retracting of outriggers.
2.	Auxiliary Tools (Optional)	Directs oil flow to the tool when connected to the quick couplers
3.	Two-Speed Throttle & Auxiliary Power (Optional)	Two-Speed Throttle provides two engine speeds, low and high, with engine running, Low speed is engine idle. Auxiliary Power provides hydraulic power to lower and stow the Aerial Device in the event of a prime power source failure.
4.	Outrigger Selector (Optional)	Directs hydraulic flow to outrigger circuit or unit when unit is equipped with outriggers.  The selector will act as an emergency stop by taking oil flow away from the active control's oil flow.

OPERATION WITH LOSS OF CHASSIS POWER

The unit may be rotated, booms moved and/or stored with the optional emergency auxiliary hydraulic pump if so equipped.

In the event the unit is not equipped with the auxiliary hydraulic pump the booms may be lowered with the use of an auxiliary power source plumbed into each individual function.

Each movement must be planned and extreme care taken during these procedures.



PERSONNEL AND TRAINING

It is required that the crew to which a new TEREX - TELELECT Aerial Device is assigned, be given an opportunity to become familiar with the operation of the equipment before they operate it on a job. The operator and other crew members should be familiar with the operating procedures. The crew should perform dry run operations until they attain a safe degree of proficiency.

NOTE: Refer to the load chart for rated capacities, boom angles and load radius.

NOTE: Do not exceed load chart capacities.

⚠ DANGER

**FAILURE TO OBEY THE FOLLOWING
WILL RESULT IN
DEATH OR SERIOUS INJURY**

- For stationary operation, truck must be securely parked, driveline disengaged, and Aerial Device properly stabilized prior to operation.
- To avoid tip-over, outriggers (when so equipped) must be properly extended on a solid level surface.
- Operate all controls slowly for a smooth platform motion and make sure controls are returned to neutral after desired operation.
- Crew must use proper personal and other protective equipment.
- Never load beyond rated capacity.
- Never operate Aerial Device with personnel under boom or load.
- Never move the truck until the booms and outriggers are in a properly stowed position and secured.
- Refer to the operator's manual for complete instructions. If missing, replace manual.

419262

⚠ DANGER

**AN UNTRAINED OPERATOR
SUBJECTS HIMSELF AND
OTHERS TO
DEATH OR SERIOUS INJURY**

**YOU MUST NOT OPERATE
THIS MACHINE UNLESS**

- You have been trained in the safe operation of this machine.
- You have read, understand and follow the safety and operating recommendations contained in the machine manufacturer's manuals, safety signs attached to equipment, your employer's work rules and applicable government regulations.
- You are sure the machine is operating properly and has been inspected and maintained in accordance with manufacturer's manuals.
- You are sure that all safety signs, guards and other safety features are in place and in proper condition.

419267

Learn the operators inspection and field maintenance requirements. Many times simple maintenance procedures can prevent expensive breakdowns. A brief preliminary check of oil levels and operating conditions of the Aerial Device should be made daily before the Aerial Device is put into service.

If service is indicated, do not delay. Malfunction of one component can cause serious injury to the operator or to others if not corrected immediately.

The operator should also know the brand and grade of oil used in the hydraulic system and, if needed, where more can be obtained.

It takes a desire to learn and a pride of accomplishment on the part of the operator to achieve the proficiency and technique of operation necessary to get the most out of this equipment. The equipment will make the job easier and more productive if a high degree of proficiency is attained.

A WELL-TRAINED CREW IS A PRODUCTIVE CREW!

PRE-OPERATION

DAILY PRE-OPERATION CHECKS

Before operating the Aerial Device (with boom in stored position) check the following:

- Fuel gauge to make sure of truck fuel supply.
- Tires for damage or under-inflation.

TL Series

Table of Contents

- Hand brake and/or brake lock for proper operation.
- Truck warning lights for proper operation.
- Loose objects for proper storage.
- Hydraulic oil level in the tank. Must be at FULL mark on the dipstick. All booms and outriggers stored.
- Hydraulic lines for leakage.
- Power take off (PTO) engagement and hydraulic hoses for twisting, chafing or any accidental abrasions.
- Aerial device parts for any damage (hydraulic cylinder, pins, welds, structural members, loose bolts, etc.)
- Fiberglass upper boom and fiberglass lower boom insert for cracks and cleanliness. (Could affect structural strength and insulating properties of fiberglass.)
- Fall protection with lanyard, in the platform or at the operator's platform .
- Effectiveness of controls by operating all Aerial Device functions - set outriggers into operating position before raising the boom from the boom rest. Run unit through its complete boom travel cycle using lower controls.
- Holding valves by stopping the truck engine with boom in raised position and operating ground controls.
- Winch line for chafing or other damage.

PRE-OPERATIONAL PROCEDURES

Before locating the truck in position to work, a careful survey of the job site should be made. This survey should determine where to park the truck to take full advantage of its capabilities. Plan the position so that as much work as possible can be done without moving the truck. Consider the slope of the ground and whether or not it is firm enough to support the outrigger weight.

Use the following procedures when positioning the truck on a work site:

- Turn the warning lights on.
- Set the brakes. Place wheel chocks in position.
- Place signs, warning lights, and barricades in accordance with company safety regulations and state laws.
- When working on or near energized lines, ground and/or barricade unit.
- Engage the power take off (PTO).
- Set outriggers.
- Remove upper boom tie down.

Operating Temperature Range

The ambient operating temperature range of the unit is given on the ID plate. Operation at the extremes of the temperature range requires extra precautions.

Cold weather operation below 10 degrees F requires:

- The hydraulic system must be filled with hydraulic fluid having a pour point suitable for the temperature.
- The hydraulic system must be properly warmed up:
 - Operate the pump at idling speed to allow the oil to warm up gradually. Cold, thick, sluggish oil may not move fast enough and will starve the pump, thus causing severe damage.
 - Circulate the oil through the system by cycling each function from the lower controls before operation from the platform.
 - The addition of oil heaters may be required.
- Operate the boom and functions slowly to prevent jerking and shock loads.
- Functions may operate sluggish and not be as responsive, so allow more time and distance when starting and stopping movements.

Hot weather operation above 100 degrees F may require intermittent operation to allow the oil to cool or





the addition of oil coolers. Do not exceed an oil temperature of 150 degrees F.

SETTING THE OUTRIGGERS (IF SO EQUIPPED)

Position the outrigger pads, lower the outriggers firmly to the ground and on the pads and keep them there until all work that can be done from that position is complete, and the boom is stored..

	If the unit is equipped with outriggers, they must be extended to provide adequate stability.
---	---

	Do not move or position outriggers with personnel in or around the outrigger path.
---	--

	DANGER
OUTRIGGER CONTACT WILL CAUSE SERIOUS CRUSHING INJURY	
<ul style="list-style-type: none"> Do not operate any outrigger unless you or a signal person can see that personnel and obstructions are clear of the outrigger and its contact point. 	
<small>419268</small>	

	DANGER
	
OUTRIGGER CONTACT WILL CAUSE SERIOUS CRUSHING INJURY STAND CLEAR	
<small>419269</small>	

If the working area is on sloping ground so that one side of the truck is low, extend the low side outrigger first and make sure that firm contact is made. In such cases, or if the outrigger extends into a ditch or gutter and the full extension does not make firm contact, it must be blocked up. Be sure the outrigger is centered on the pad or blocks.

TL Series

Table of Contents

Set outriggers firmly on the ground, but do not raise weight of vehicle off ground.

Level the truck as level as possible without raising a tire off the ground.

Properly Setting The Outriggers

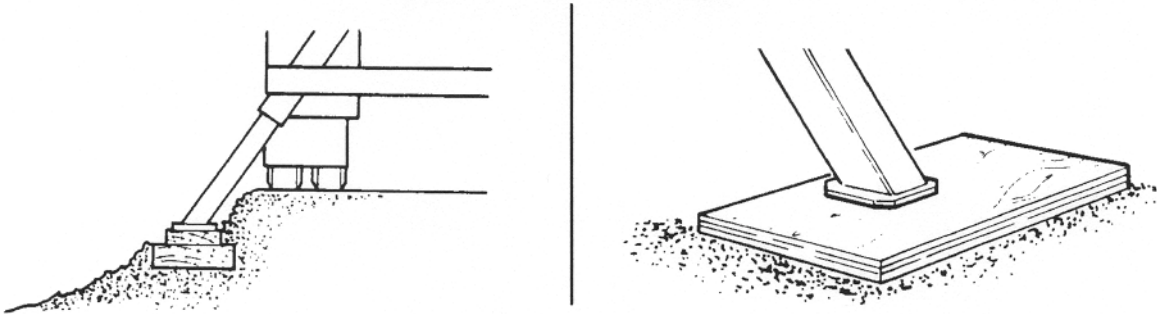

When working from sloping or uneven ground so that the truck is not level, position truck so that loads will not be rotated to the low side. if on a slope, position the truck down the hill so the boom work area is up the hill.

Do not operate units with one set of outriggers with tires off the ground.

BEFORE OPERATING THE AERIAL DEVICE ALWAYS BE SURE THAT THE OUTRIGGERS ARE PROPERLY SET.

When the work site demands that the vehicle be positioned so that one outrigger must be set on a curb with the vehicle in the street, the span is shortened and the balance point is affected, restricting the load capacity to the side.

If the ground is too soft to support the weight on the outrigger pad, additional pad supports must be used to increase the support area. A recommended pad is 24" x 24" pad made of three layers of 3/4" plywood.



Setting Up for Operation on Snow and Ice

Operation on snow and ice add an additional problem due to the slippery conditions. Normal traction is greatly reduced. Just as you need to maintain traction to walk and drive, it is required to keep Aerial Devices in a stable position. Rotating and moving the booms may cause the truck to jerk and move. If the unit is not set up securely the truck can slide on ice and snow while operating.

When planning your work remember that driving in snow causes snow dust to be deposited on all surfaces. The outriggers and outrigger pads will get snow covered and slippery. Also, as you put pressure on snow, the snow packs down and turns to ice.

The person setting the unit up for operation has the entire responsibility for a stable position. The person on the site is the only one who can evaluate the conditions and terrain.

Proper set up requires:

- Outriggers do not slide on the outrigger pads during use.
- Outrigger pads do not slide on the ground during use.
- Set the parking brakes
- Chock wheels as required, to prevent movement down hill. Evaluate chock location to prevent the truck pivoting around one chock.
- Set units with one set of outriggers so all tires are on the ground.
- Evaluate the terrain to determine the most flat and level set up position.
- Set up truck so if the truck does move slightly, the result isn't catastrophic.
- Do not place outriggers on Ice as slippage may occur regardless of solid footing.

To properly set up you may need to:

- Remove snow and ice down to bare ground to prevent sliding and to evaluate the support available. Don't set outriggers on a manhole cover or the edge of a slope or drop off.
- Move as far as required into the street or road so if the truck does move, the tires and outriggers will not slide into the ditch or other hazards.
- Choose a location for the truck that gives the best stability for the work to be done.
- Come back later, to do the work, if the roads are not cleared sufficiently.
- Use traction aids under the tires and outriggers such as sand and gravel or mats.

Operate the unit smoothly by "feathering" the controls, not jerking the levers.

STABILITY

The stability of a vehicle equipped with a rotating Aerial Device depends on the gross weight of the vehicle and load, the slope of the work area, and whether the ground is firm enough to support the weight of the chassis on the outrigger pads. These conditions are widely variable, so the operator must exercise good judgment and extreme caution to learn just what his particular vehicle and operating conditions can handle.



Increasing the distance from the truck to the load will affect the stability of the Aerial Device.



This Aerial Device has been tested for stability on a maximum slope of 5 degrees. Working on slopes that exceed this 5 degrees may result in truck tipping over.



Units operated with torsion bars only require truck tires and suspension system to provide stability. Failure of these components may cause unit to tip over.

TL Series

Table of Contents

OPERATION

Before using the Aerial Device, the operator should be assured that he has checked through the pre-operational procedure making sure that the truck is properly positioned, outriggers (if furnished) are firmly in place, or torsion bar is engaged. Extreme care should always be exercised when lifting personnel.

Before entering the platform place the control selector at the lower controls in the top control position.

After entering the platform, attach the safety lanyard to the anchor provided. Fall protection must be used (OSHA 1910-67 -OSHA 1926.556).



	<ul style="list-style-type: none"> •Do not allow any part of the Aerial Device to come in contact with electrical conductors, either energized or non energized. •Wear your rubber gloves and sleeves. •Install shields, covers, mats, on all energized and grounded conductors. •Wear protective and insulated head gear. •Use platform liner. •Death or serious injury could result from such contact or inadequate clearance
---	---

	<p>Do not move truck with personnel in platform. This unit is not designed for this type of operation.</p>
---	--

Study the movements required to reach the work location. Use a feathering technique with control levers to ease the unit to smooth starts and stops. Use low speeds for starting and stopping motion, when approaching aerial job site, and when prolonged stops will be made. Use high speed only between ground and job site and job site and ground. Always look in the direction the unit is traveling to be certain there is clearance for boom, platform and operator.

Raise upper boom and lower boom to clear all truck obstructions before rotating.

Avoid sudden stops or reversal of rotation as this can accelerate wear and/or cause damage to the rotation mechanism.

Be aware of any obstacles the lower boom may strike if rotated or elevated. Also any objects which the main boom may come close to as movements are made.

	<p>Make certain that all personnel are in the clear and that there is sufficient overhead clearance before operating the Aerial Device.</p>
---	---





DO NOT LEAVE THE PLATFORM TO BUILD TRESTLES BETWEEN THE PLATFORM AND ANOTHER SUPPORT WORK LOCATION.

AVOID CARELESS HANDLING OF TOOLS AND EQUIPMENT WHILE ALOFT. USE A TOOL TRAY TO HELP PREVENT DROPPING ITEMS. KEEP CREW MEMBERS AWAY FROM THE AREA DIRECTLY UNDER THE WORK POINT UNLESS ABSOLUTELY NECESSARY, AND CAUTION THEM THAT IT IS NECESSARY TO BE CONSTANTLY ON THE ALERT FOR POSSIBLE FALLING ITEMS.

CAB CONTROL OPERATION

MASTER CONTROL

The master control is a standard control which consists of a toggle switch (A) and a light (B) mounted on the dashboard of the truck. The toggle switch is used to energize or de-energize the stop/start system and the throttle control options, which may be located in the cab, at the platform, and the pedestal. When the light is lit the toggle switch is energizing these systems.

ENGINE STOP/START (OPTIONAL)

The engine stop/start (C) is a push button control and is usually mounted on the dashboard of the truck. The system is activated by pushing the button once and deactivated by pressing the button again. This feature is especially convenient when the ground controls are used.



BE SURE THE TRUCK TRANSMISSION IS IN NEUTRAL AND BRAKES APPLIED BEFORE USING THE ENGINE STOP/START.

Cab Controls mounted on the truck dashboard

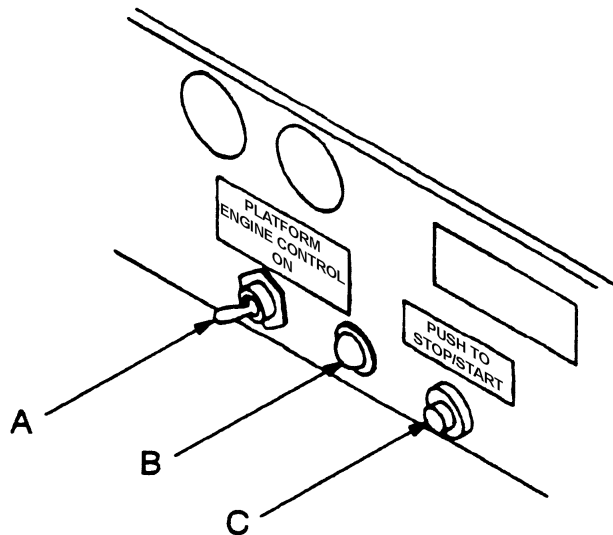

(PTO) POWER TAKE-OFF (IF SO EQUIPPED)

The power take-off is a gearbox used to transmit power from the truck transmission to the hydraulic pump, which provides hydraulic oil for the Aerial Device functions. The power take-off control consists of a "push-pull" knob usually mounted on the cab floor and a red light mounted in the truck dashboard. When lit this red (PTO) dash light indicates the PTO is activated and serves to remind the operator not to drive the truck with the PTO engaged.

NOTE: Driving with the PTO engaged may damage both the pump and the PTO.

To engage the power take-off properly refer to the PTO manufacturer's operating instructions and be sure the manufacturer's operating decals are posted in the cab with the PTO controls.

TL Series

Table of Contents

NOTE: The cable should be installed so the PTO is engaged when the PTO knob is pulled "out" and disengaged when the PTO knob is completely pushed "in".

OUTRIGGER CONTROL OPERATION (OPTIONAL)

The outriggers (if so equipped) should always be extended to provide stability for the TL Series Aerial Device. The outrigger controls consists of a selector lever control for each outrigger.

The selector is used to select between outrigger operation or Aerial Device operations.

The selector must be in the outrigger position for the outriggers (ground controls) to operate. Then a spring-loaded control valve lever is used to "raise" or "lower" each outrigger. Because the outrigger control levers are spring-loaded the handles will return to the neutral or centered position unless held in an operating "raise" or "lower" position. One outrigger control valve operates a single outrigger. The control valve must be located where the operator can watch the outrigger "raise" or "lower" as the control valve lever is activated.



The selector will act like an emergency stop by taking oil flow away from the active controls.

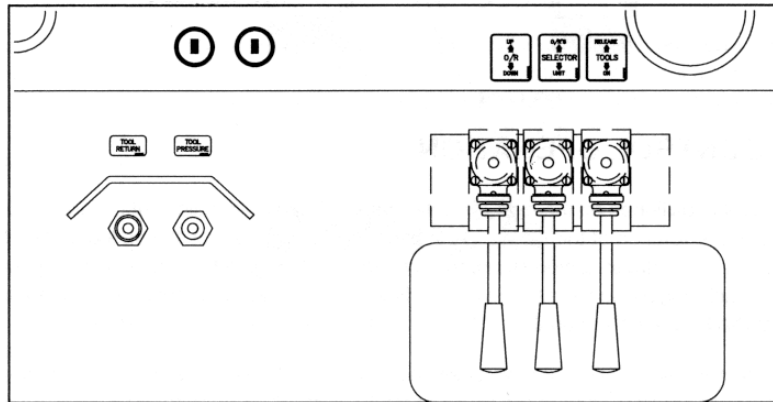

OUTRIGGER BOOM INTERLOCK (OPTIONAL)

The outrigger boom interlock is designed to prevent the boom from being operated until the outriggers are extended. The interlock also prevents the outriggers from being retracted before the boom is stored.

The outriggers will function when the boom is in the rest. If the boom is raised out of the rest, the outriggers will not operate. The boom will not operate if the outriggers are not extended.



HYDRAULIC TOOL OPERATION AT THE GROUND (OPTIONAL)

The Aerial Device can be equipped with **open center hydraulic tools** that operate at 2000 PSI (141 kg/cm²) and 5 GPM (19 LPM) at the ground controls. Connect the hydraulic tool hoses to the tool power outlets (quick-disconnect couplings) and activate the tool power valve by pulling the tool power valve knob "out". The other Aerial Device controls will not respond while the hydraulic tools are being operated. To disconnect the hydraulic tools, the tool power valve must be turned "off" so that the pressure in the system is relieved. This is done by pushing the tool power valve knob "in". Then the tool hoses can be disconnected safely and easily from the tool power outlets (quick-disconnect couplings).

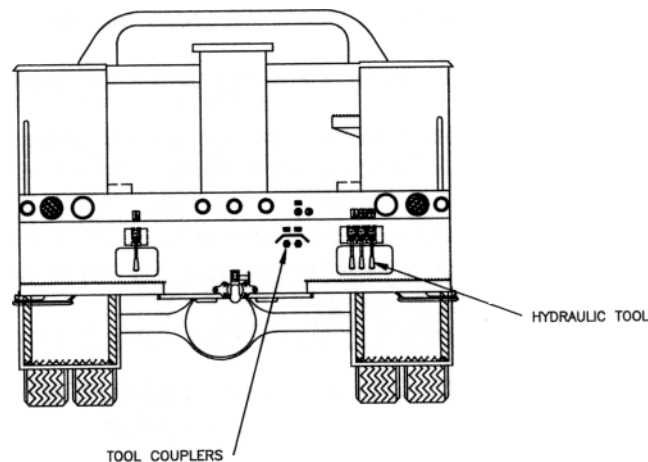

LOWER CONTROL OPERATION

The lower controls positioned on the side of the turntable. These hydraulic controls are used to operate boom movements and the rotation of the boom. An optional electrical control station located on the pedestal and include the following controls: a stop/start control for the truck engine (optional), a two-speed manual throttle control for the truck engine to increase hydraulic flow for tool operation (optional), and an auxiliary hydraulic power control for the boom (optional).

The control selector lever, which has two positions is used to choose between either operating the aerial device from the upper controls or from the lower controls. Note the upper controls are not operable when the lower controls are selected and vice versa.

The remaining control levers at the turret are spring-loaded. The control lever decals identify each control lever function. The arrows on the control lever decals indicate which position to push and hold the control lever to select the direction of "rotation" (i.e. clockwise or counter-clockwise) or the direction of a boom movement (i.e. "raise" or "lower"). When the control lever is released it will return to the centered or "off" position and motion will cease.

Table of Contents

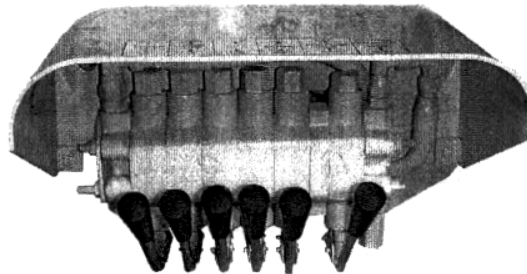
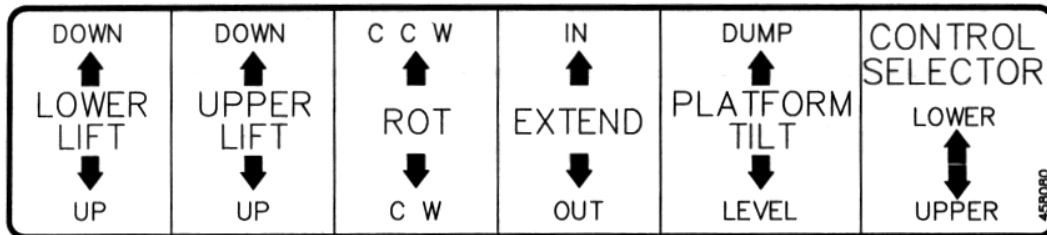

HYDRAULIC PLATFORM LEVELING CONTROL (OPTIONAL)

(Standard with end mount platforms)

Platform leveling is achieved automatically with a master slave cylinder combination. A hydraulic control lever (labeled "Platform Leveling") is used to adjust platform leveling, to tip the platform for clean out, or to ease the removal of an injured operator. A placard identifies the hydraulic platform control lever and indicates the direction to push the control lever to coordinate the fore-and-aft leveling of the platform. Do not operate the upper boom unless the platform is in a level position.



Do not operate platform leveling with operator in the platform except in an emergency.

ENGINE STOP/START CONTROL (OPTIONAL)

The engine stop/start control is convenient for the ground crew at the pedestal. The engine stop/start control is operated by a push button switch labeled "Engine" at the pedestal.

To start the engine from the pedestal the truck key must be in run position and the master switch in the cab is "on". Push the switch and hold in that position for a moment until the engine "starts", then release.

To stop the engine from the pedestal when running, push the switch, then release. Refer to Emergency Operation for further information on the use of this control in an emergency. The engine will crank as long as the switch is held in the "start" mode. If it fails to start, release and let the starter cool down. the control "toggles" between start and stop mode, so it is necessary to push and release, then push again to crank the engine if the engine fails to start.

TWO-SPEED THROTTLE CONTROL (OPTIONAL FOR 5 GPM TOOLS)

The two speed increases the engine speed when more hydraulic flow is required for tools. Idle speed is used for boom operation. The two-speed throttle control is operated by a push button switch at the pedestal.

To speed up the engine from the pedestal, push the switch and release.

To slow down the engine to an idle from the pedestal, push the switch and release.

AUXILIARY HYDRAULIC POWER CONTROL (OPTIONAL)

If the Aerial Device's power source fails, the auxiliary power control activates hydraulic power to stow the Aerial Device. The auxiliary hydraulic power control is combined with the two-speed control, if the unit is equipped with optional stop/start. If the engine is not running, the auxiliary power will be turned on and off by pressing and holding the two-speed push button.

The auxiliary hydraulic power system should not be operated longer than 30 seconds continuously. Continuous use will drain the battery and damage (over heat) the auxiliary pump motor. Operate the control only while activating a boom function.



UPPER CONTROL OPERATION

SINGLE STICK CONTROL (STANDARD)

The control is located at the boom tip on the side of the platform.

The actuator lever must be squeezed to activate the system. A control lever placard indicates the direction to move the single stick to activate a specific boom movement.

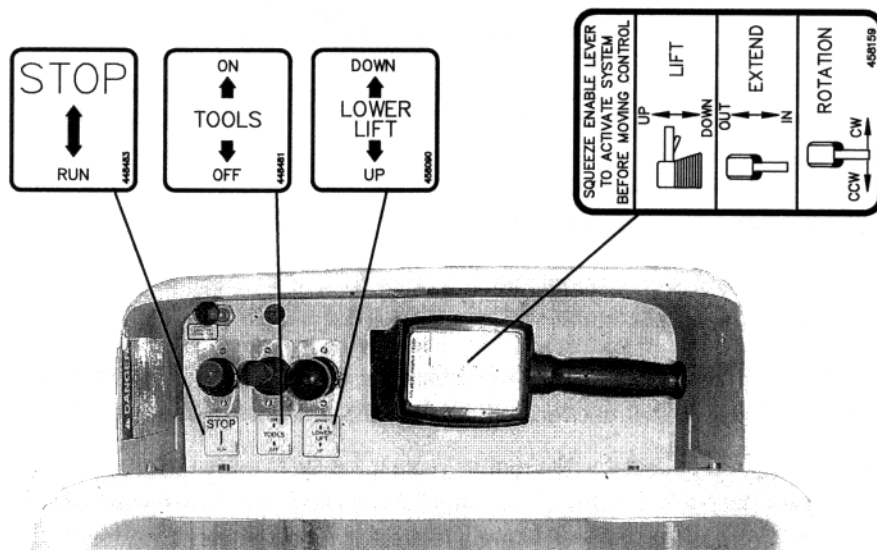

The operator needs to be familiar with the built-in compensating system that affects movements of both booms and the boom controls. When the lower boom function is activated the lower boom will respond as directed and the upper boom will maintain its initial angle in relation to the ground. The platform will move the same distance and direction as the upper end of the lower boom moves. Activating the upper boom function will move the upper boom only.

EMERGENCY STOP CONTROL (STANDARD)

The control knob on the extreme left is the emergency stop, which diverts or dumps all the hydraulic oil flow directly to the reservoir when pushed. The emergency stop disables all operations at the platform including the hydraulic tools. Push away to stop movement. Pull back to resume operation.

HYDRAULIC PLATFORM ROTATOR (OPTIONAL)

An operator can rotate the platform by moving the control lever. The platform will rotate 180° from one side of the boom across the end hung position, and to the other side of the boom assembly.

HYDRAULIC PLATFORM LEVELING CONTROL (OPTIONAL)

Platform leveling is achieved automatically with a master slave cylinder combination. However a control lever (labeled "Platform Leveling") at the lower control is used to adjust platform leveling, to tip the platform for clean out, or to ease the removal of an injured operator. A placard identifies the hydraulic platform control lever and indicates the direction to push the control lever to coordinate the fore-and-aft leveling of the platform. Do not operate the upper boom unless the platform is in a level position.

TL Series

Table of Contents**TOOL POWER CONTROL LEVER (OPTIONAL)**

This control lever is labeled "Tool" on the upper control panel at the platform. To select the tool power function move the control lever from the system position to tool position. To connect or disconnect tools to the hydraulic tool ports the tool power control lever must be in the "off" position so pressure in the system is relieved. When tool power is selected the Aerial Device will not be operable.

Tool operation directs the oil flow to the hydraulic tools causing the Aerial Device to be inoperable. To connect or disconnect the hydraulic tools, the control selector handle must be in the system position. Disconnect the pressure line first when removing the tool. Hydraulic tools used with this Aerial Device must be open center and accept up to 5 GPM (19 LPM) at 2000 PSI (141 kg/cm²).



ALWAYS RELIEVE THE PRESSURE TO THE HYDRAULIC TOOL PORTS BEFORE ATTEMPTING TO CONNECT OR DISCONNECT THE HYDRAULIC TOOL HOSES. WHEN THE TOOL POWER CONTROL LEVER IS IN THE "OFF" POSITION SYSTEM PRESSURE IS RELIEVED.

AUXILIARY HYDRAULIC POWER CONTROL (OPTIONAL)

The optional auxiliary hydraulic power control is operated by an air cylinder plunger knob labeled "Auxiliary Power". To activate this system push the air cylinder plunger knob down and release. To turn "off" the hydraulic power, push and release the air cylinder plunger knob again. The auxiliary hydraulic power system should not be operated longer than 30 seconds continuously. Continuous use will drain the battery and damage (over heat) the electric motor. When tow-speed option is included, the same control knob is used for both. When the engine is running the two-speed will function. With the engine off, the auxiliary power will operate.

ENGINE STOP/START CONTROL (OPTIONAL)

The engine stop/start control cannot be operated unless both the truck ignition and the master control are "on". This feature makes it difficult for unauthorized individuals to operate the Aerial Device when the truck is locked. At the platform the engine stop/start system is operated by an air cylinder plunger knob labeled "Engine" and is located with the upper controls.



BE SURE THE TRUCK TRANSMISSION IS IN NEUTRAL AND THE PARKING BRAKE IS ON BEFORE ACTIVATING THE ENGINE STOP/START CONTROL.

To "start" the truck engine from the platform, push the air cylinder plunger knob (labeled "Engine") "down" and hold it there a moment until the engine "starts". If the truck's starter does not cause the engine to crank, release the plunger knob and allow the plunger to rise to the neutral position. Again push the air cylinder plunger knob "down" and hold it there. Then release the plunger knob after the truck has "started". The second push on the plunger may be required to get the latching relay into the "start" position so the truck will "start".

To "Stop" the truck engine from the platform, simply push the air cylinder plunger knob "down" again.

TWO-SPEED THROTTLE CONTROL (OPTIONAL FOR 5GPM TOOLS)

The optional two-speed manual throttle control is operated by an air cylinder plunger knob labeled "Throttle" with the upper controls at the platform. The two-speed throttle control is designed to operate only if both the key in the truck ignition and the master control are "on".

To speed up the engine from the platform, push the air cylinder plunger knob (labeled "Throttle") down once and then release it.

To slow down the engine speed to an idle from the platform, push the air cylinder plunger knob down again. It is recommended that the engine be left at idle unless full tool flow is required. This practice will provide the most efficient operation and minimize fuel consumption. The booms are designed to operate at engine idle speed only.



MATERIAL HANDLING

This Aerial Device is designed primarily as a personnel lift. Whenever tools or equipment are included with the operator in the platform the combined weight must not exceed the rated load capacity of the Aerial Device.



Never exceed the rated load capacity of the Aerial device. Structural damage or instability can result causing death or serious injury.

The optional lifting eye has been designed to accommodate limited material handling. Always extend the out riggers (if so equipped) when using the boom lifting eye. Boom movements should be smooth to avoid swinging the load. Do not exceed the load limits stated on the decal beside the lifting eye. To prevent damage to the unit avoid dragging the loads with the lifting eye. This would subject the Aerial Device to damaging side loads. When lifting loads, position the boom directly over the load before lifting. The platform must be empty and fully retracted when lifting loads. When the truck is not level extreme caution must be used when rotating loads to the low side because the truck's stability will be affected. **Use of the platform for material handling shall be avoided.** The platform was designed to lift personnel only.



Increasing the horizontal distance from the truck to the load will affect the stability of the truck. Be careful when lifting and lowering a load with the boom.



Platform shall be empty when using the lower boom lifting eye for material handling.

The platform shall not be used for material handling.

EMERGENCY OPERATION

Emergency operation may be required if an operator is injured or the equipment malfunctions. In any emergency, the first priority is always the safety of the personnel involved. It is always important to remember to follow the standard work practices and the safety regulations that apply. If the Aerial Device is operable move the platform away from the danger and into the shortest, clear path of descent to get the operator on the ground. If the Aerial Device is inoperable consider using another Aerial Device to rescue the operator from the platform. If an equipment defect is suspected don't allow anyone to enter the platform. Instead if the situation allows safe operation from the lower controls, override the upper controls and carefully lower the platform to the ground.



CONTROL SELECTOR

When a situation requires the upper controls be overridden (i.e. an injured operator in the platform) use the control selector at the lower controls to select the "lower" controls for operation of the Aerial Device. This will make the upper controls inoperable. Then the "lower" controls can be used to lower the operator to the ground.

MANUAL ROTATION

If all the hydraulic power sources become inoperable, the Aerial Device rotation system can be actuated manually. Use a 7/8" hex socket, an extension, and a ratchet to rotate the input shaft on the gearbox. Actuating the lower rotation control will reduce the effort required for the rotation.

TL Series

Table of Contents

AUXILIARY HYDRAULIC POWER (OPTIONAL)

The auxiliary hydraulic power system provides hydraulic power from a DC motor-pump for operation of the Aerial Device in the event of a prime power source failure. Controls for auxiliary hydraulic power are located at the platform and optional at the pedestal and at the outrigger controls.

At the platform the auxiliary hydraulic power is operated by an air cylinder located with the upper controls. To activate this system, push the air cylinder's plunger knob (labeled "Auxiliary Power") then operate the controls. To turn "off" the hydraulic power, release the air cylinder's plunger knob and hold. The auxiliary hydraulic power system should not be operated longer than 30 seconds continuously. Continuous use will drain the battery and damage (over heat) the motor.

At the pedestal and the outrigger controls (if equipped), the auxiliary hydraulic power is operated by a push button switch. To activate this system push and release the switch. To turn "off" the hydraulic power release switch. The auxiliary hydraulic power system should not be operated longer than 30 seconds continuously. Continuous use will drain the battery and damage (over heat) the power motor.

When two-speed option is included, the same control is used for both. When the engine is running the two-speed operates. When the engine is off, the auxiliary power operates.

INJURED OR INCAPACITATED OPERATOR

If the operator is unable to operate the Aerial Device, determine if any damage has occurred to make the Aerial Device inoperable. If the situation allows safe operation from the lower controls override the upper controls and carefully lower the platform to the ground. See "Control Selector" to override the upper controls. If the Aerial Device will not operate due to damage incurred, consider one of the other auxiliary operating procedures presented in this section to solve the problem.

HYDRAULIC LINE FAILURE

Hydraulic line failure during Aerial Device operation presents numerous hazards. Be aware that a hydraulic oil mist caused by a leak or hydraulic line failure is conductive even though a non-conductive oil is used. Oil is very flammable when sprayed out under pressure.

In addition a hydraulic line leak can create a vacuum in the line which is also conductive. Furthermore, most hydraulic oils are flammable if ignited. Another danger to personnel are burns from contact with hot oil. The operator and the ground crew must be alert for these hazards to avoid injury.



A SPRAY OR MIST PRODUCED BY A HYDRAULIC LEAK UNDER PRESSURE IS VERY HAZARDOUS TO PERSONNEL. THIS SPRAY OR MIST CAN PUNCTURE OR BECOME EMBEDDED BENEATH THE SKIN. THIS CONDITION WOULD REQUIRE IMMEDIATE MEDICAL ATTENTION.

A quick response to hydraulic line failure is important, if the operator is to be safely removed from the platform. The examples below describe some emergency operating procedures to follow for some specific types of hydraulic line failures.

- The TL Series Aerial Device design uses holding valves to lock the position of the booms in the event of a complete hydraulic line failure. This safety feature prevents the booms from dropping.
- If there is a continuous loss of hydraulic oil from the Aerial Device, operate the hydraulic power source only while attempting to stow the Aerial Device to conserve the hydraulic oil supply.
- A hydraulic line failure located between the upper and lower controls may temporarily allow the continued operation of the Aerial Device. The rate of the hydraulic oil loss can be reduced by overriding the upper controls and operating the Aerial Device with the lower controls. Thus the intermittent loss of hydraulic oil may allow continued use of the Aerial Device or some functions until the oil supply is depleted. If the oil supply is depleted discontinue operation of the hydraulic power source to avoid damage to the hydraulic pump.

NOTE: An oil spill may require notification of Local, State, or Federal Agencies.



ENGINE FAILURE

If the prime power source fails, the optional auxiliary power system can be used for emergency operation. If this system is not installed, use the engine stop/start control to crank the engine if the truck has a manual transmission.

HYDRAULIC PUMP FAILURE

If the primary hydraulic pump fails use the auxiliary hydraulic power system, if so equipped.

CONTROL VALVE FAILURE

A control valve malfunction could develop in either the individual control levers or the multi-function single stick control.

If Aerial Device motion cannot be stopped because a control lever will not return to the centered or neutral position, activate the emergency stop mode by pushing down the emergency stop. The emergency stop position will disable the boom controls which will stop the Aerial Device's motion. If the engine stop/start control is installed, "stop" the engine and the Aerial Device's motion will cease. Then manually attempt to center the spring-loaded control lever before restarting the engine. If the spring-loaded control lever at the platform will not return to neutral, the Aerial Device can be operated by overriding the upper controls with the lower controls.

After any emergency situation, it is the operator's responsibility to notify appropriate maintenance personnel to make sure the Aerial Device is repaired and adjusted.

Identifying the problem and initiating the recommended emergency procedures promptly will help to minimize or possibly prevent injuries.

LEAVING THE JOB SITE

- Retract the upper boom fully.
- Rotate turntable to stored position.
- Lower the lower boom fully.
- Lower the upper boom into its rest.
- Remove all tools and supplies from platform. Position the platform cover in place if one is supplied. Place platform in stored position for travel.
- Connect and tighten the boom tie down strap.



If the upper boom tie down strap is not in place for over the road travel, the upper arm fiberglass can be damaged to the point that failure may occur.

- Make sure that outriggers are fully retracted and if extra pads have been used that they are properly stored or disengage torsion bar (whichever is applicable). Stow all loose tools and equipment. Turn off vehicle warning lights.
- Disengage PTO before travel to prevent damage.
- Remember the overall height of the unit.
- Shut off master switch.
- If any problems were encountered during operation, report them to the proper person(s) for maintenance and repair.

Drive carefully!

SECTION 2: MAINTENANCE GUIDELINES

PREVENTATIVE MAINTENANCE

A preventative maintenance program based on the manufacturer's recommendations shall be established. Dated and detailed inspection and repair records shall be maintained.

It is recommended that the replacement parts for your Aerial Device be obtained from a Terex Telelect distributor or Terex Telelect.

MAINTENANCE PROCEDURE

Before adjustments and repairs are started the following precautions shall be taken as applicable:

- You must be authorized by owner to operate unit.
- Place machine where it will cause the least interference with other equipment or operations in the area.
- All controls at the off position and all holding valves operative.
- Starting means rendered inoperative.
- Warning or "**OUT OF ORDER**" signs placed on the machine.
- Use lockout/tagout procedure to prevent operation.
- Power plant stopped or disconnected at takeoff.
- Boom lowered to the ground if possible or otherwise secured against dropping.
- Lower boom secured against dropping.
- Relieve hydraulic oil pressure from all hydraulic circuits before loosening or removing hydraulic components.

After adjustments and repairs have been made the machine shall not be operated until all guards have been reinstalled, trapped air removed from hydraulic system, safety devices reactivated, and maintenance equipment removed.

Warning or "**OUT OF ORDER**" signs shall be placed and removed by authorized personnel only.

ADJUSTMENTS AND REPAIRS

Any unsafe conditions disclosed by the inspection requirements of this section shall be corrected before operation of the machine is resumed. Adjustments and repairs shall be done only by qualified personnel.

Adjustments shall be maintained to assure correct functioning of components. The following are examples:

- All functional operating mechanisms.
- Safety devices.
- Control systems.
- Power plants.

Repairs or replacements shall be provided promptly as needed for safe operation. The following are examples:

- All critical parts of functional operating mechanisms which are cracked, broken, corroded, bent or excessively worn.
- All critical parts of the machine structure which are cracked, bent, broken or excessively corroded.

All replacement parts or repairs shall have at least the original safety factor. Do not alter, modify, rework, or replace any part of the Aerial Device without the approval of the manufacturer.



The modification, rework, replacement, or substitution of any part of the Aerial Device with a means not equal to or lesser than the original equipment provided by the manufacturer may cause serious personal injury

NOTE: Do not use hoses having less than 2750 PSI working pressure. Only us Orange hoses marked "Non-Conductive" for hydraulic tools at the boom tip and in areas that bridge the insulation gaps.



LUBRICATION

All moving parts of the machine, for which lubrication is specified, shall be regularly lubricated. Lubricating systems shall be checked for proper delivery of lubricant. Particular care should be taken to follow manufacturer's recommendations as to points and frequency of lubrication, maintenance of lubricant levels and types of lubricant to be used.

Machinery shall be stationary while lubricants are being applied and protection provided as called for in "Maintenance Procedure".

OPERATIONAL CHECKLISTS

All checks must be completed before operation of the Hi-Ranger TL Series Aerial Device.

GENERAL INFORMATION

1. Keep inspection records up-to-date.
2. Record and report all discrepancies to your supervisor.
3. A dirty machine cannot be properly inspected. **Keep your Hi-Ranger TL Series Aerial Device clean!**



THE FOLLOWING CHECKLISTS MUST BE USED DAILY, 30 DAYS (120 HOURS), 90 DAYS (360 HOURS), 180 DAYS (720 HOURS), AND 12 MONTHS (1,050 HOURS). FAILURE TO DO SO COULD ENDANGER THE LIFE OF THE OPERATOR. ALWAYS REMEMBER, PREVENTIVE MAINTENANCE CAN SAVE MUCH MORE THAN IT COSTS.

NOTE: The following check points listed are the minimum recommended by Terex Telelect. They are subject to supplementation to conform with your own company regulations.

NOTE: Remember that the safety of all personnel and the operational efficiency of the Aerial Device are dependent upon good inspection checks and maintenance practices.

NOTE: Dirty or dusty conditions or unusual weather conditions may require more frequent maintenance.

FREQUENT AND PERIODIC INSPECTION INTERVALS

DAILY

1. Check controls at platform and lower controls for proper operation.
2. Inspect fall protection equipment and attachment.
3. Inspect visual and audible devices.
4. Check cleanliness and dryness of fiberglass components.
5. Check for missing and illegible operational or instructional markings.
6. Visually check oil level in hydraulic reservoir.
7. Inspect for leaks in hydraulic system.
8. Visually check all cylinders for leaks.
9. Visually inspect leveling system.
10. Visually inspect all fasteners for tightness.
11. Visual inspection of all structural members for cracks and permanent deformation.
12. Check for rotational obstructions.
13. Visual inspection of all electrical wires.
14. Operational test of all boom functions.

90 DAYS (360 HOURS)

*All Daily Items

1. Visually inspect all pins.
2. Lubricate all points per lubrication chart recommendations.
3. Apply lubricant to rotation gear box and winch speed reducer. (See Lubrication Chart)
4. Repair or replace items found to be worn or damaged.

180 DAYS (720 HOURS)

1. Replace return filter.
2. Inspect exposed hoses.
3. Clean hydraulic tank breather.
4. Check tightness of rotation bearing bolts, mast bearing, and bearing to pedestal for proper torque.
5. Daily and 90 Day (360 Hours) Inspection.

12 MONTHS (1,050 HOURS)

1. Inspect and lubricate PTO drive shaft to pump.
2. Take samples of hydraulic oil and test.
3. Check all system pressure adjustments for proper setting.
4. Critical weld inspection.
5. Perform dielectric test booms and platform liner.
6. Daily, 90 Day (360 Hours) and 180 Day (720 Hours) Inspection.



LUBRICATION CHART

TEREX TELELECT
TL36P

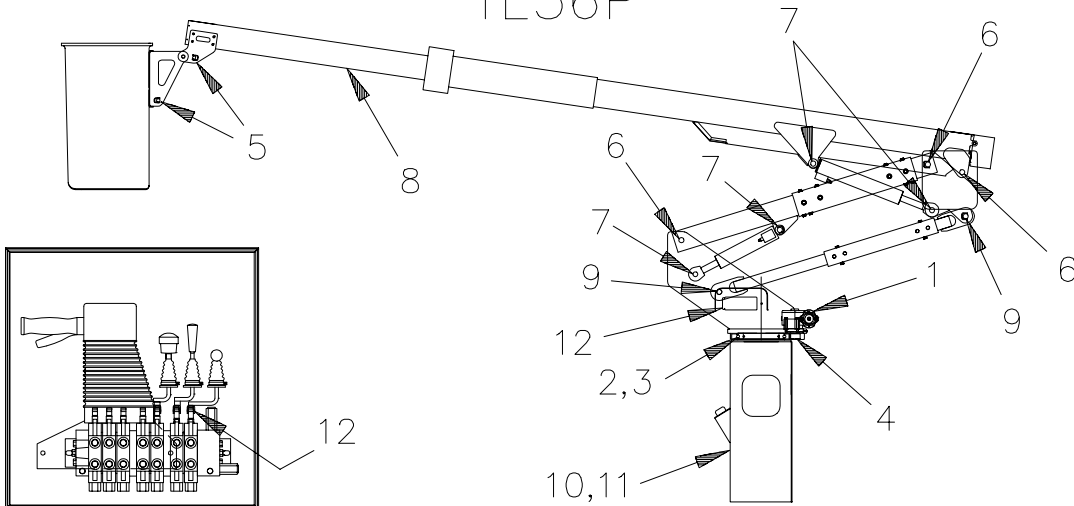

ITEM	LUBRICATION POINT	LUBRICANT RECOMMENDED	SERVICE	
			INTERVAL	METHOD
1	ROTATION SPEED REDUCER	MOBILUX EP 023	90 DAYS OR 360 HOURS	† FILL IF LOW
2	ROTATION BEARING	LITHIUM-BASE EP #2 GREASE		GREASE GUN
3	ROTATION GEAR TEETH			
4	PINION GEAR TEETH			
5	BOOM TIP BUSHING			
6	BOOM PIVOT PIN			
7	LIFT CYL BUSHING	CLEAN & WAX	YEARLY OR A/R	WIPE
9	LINK ARM BUSHING	LUBRICATING OIL FOR MAINTENANCE GREASE PINS AT REASSEMBLY.	YEARLY OR A/R	SPRAY OR GREASE GUN
10	RETURN LINE FILTER	SEE MAINTENANCE MANUAL		
11	HYDRAULIC RESERVE TANK	* PREMIUM ISO 15 HYDRAULIC FLUID	DAILY	† FILL IF LOW
12	VALVE LINKAGE	LUBRICATING OIL	A/R	SPRAY

USE THE ABOVE PRODUCTS OR EQUIVALENT:

† ALWAYS DRAIN AND REFILL WHEN DISASSEMBLED OR REBUILT.

NOTE: ALL MOVING PARTS NOT EQUIPPED WITH GREASE FITTINGS SHOULD BE LUBRICATED WITH A PENETRATING TYPE LUBRICANT AS REQUIRED.

DUSTY AND DIRTY CONDITIONS WILL REQUIRE MORE FREQUENT LUBRICATION.

* DRAIN & FILL WHEN CONTAMINATED.

** LUBRICATE SPARINGLY EVERY 1/8 REVOLUTION, FOR TWO REVOLUTIONS IF UNIT HAS CONTINUOUS ROTATION.

FOR COLD WEATHER APPLICATIONS:
USE AIRCRAFT HYDRAULIC FLUID MIL-5606A - SEE MANUAL FOR PROPER FLUID SELECTION.

456833

STORAGE PROCEDURE

When a unit will not be used for a period of time, it should be prepared for storage to reduce the deteriorating effects of the environment. This includes the following:

- Wash and clean the unit to remove accumulated road grime. It can discolor the paint if left on for long periods of time.
- Clean and wax the fiberglass components. If storage is in the sun, cover the booms.
- Clean and coat the exposed cylinder rods with grease, preservative spray or heavy preservative oil.
- Clean and grease the exposed valve spools and linkage.
- Lubricate the entire machine following the lube chart.
- Check the oil for pH level and water content. Acidic oil or water in the oil may settle out during storage and can rust the interior of the hydraulic system.
- Cover the platform to prevent water from accumulating. A platform full of water can weigh over 900 lbs. and exceed the capacity of the platform.
- Ensure the hydraulic tank filler-breather filter is intact to prevent dirt entering the tank when the temperature changes.
- Grease all sliding surfaces where there is metal contact to prevent rust.
- Touch up any bare metal and where the paint is chipped or cracked.
- Spray the electric collector commutators with LPS 1 or CRC 5-56 to prevent corrosion of the surface.
- Service the truck as recommended by the manufacturer.

NOTE: The period of time between uses when the unit should be prepared for storage varies with the location. If the climate is temperate and dry it may be 4 months. If it is in a humid area next to the ocean with the salt air it may be only 2 weeks.



Appendix A

Table of ContentsAPPENDIX - A**STANDARDS AND REGULATIONS****STANDARDS AND REGULATIONS**

In addition to the operational instructions provided herein, various standards and governmental regulations must be followed in the use and operation of your TEREX TELELECT unit.

ANSI STANDARDS

ANSI standards that are applicable to the operation and maintenance of your unit:

- ANSI A92.2 (latest revision) Vehicle Mounted Elevating and Rotating Aerial Devices
- ANSI A10.31 (latest revision) Digger Derricks - Safety Requirements, Definitions, and Specifications (A partial extraction is included in this appendix)
- ANSI C2, Part 4 (latest revision) (National Electric Safety Code®) Rules for the Operation of Electric Supply and Communication Lines and Equipment
- ANSI Z133.1 (latest revision) Safety Requirements for Tree Pruning, Trimming, Repairing, or Removal

For complete, current copies of ANSI standards, you must annually write to the following:

American National Standards Institute
11 West 42nd Street
New York, NY 10036

Copies of the standards can also be found on the Internet at: www.ansi.gov.

OSHA REGULATIONS

OSHA regulations that are applicable to the operation and maintenance of your unit:

- OSHA Subpart V, Power Transmission and Distribution
- OSHA 1910.67, Vehicle Mounted Elevating and Rotating Aerial Devices
- OSHA 1910.268, Telecommunications
- OSHA 1910.269, Electrical Power Generation, Transmission, and Distribution
- OSHA Subpart M, Fall Protection
- OSHA 1910.147, The Control Of Hazardous Energy (Lockout/Tagout)
- OSHA Subpart S, Electrical
- OSHA 1910.333, Selection and use of work practices

For complete, current copies of OSHA regulations, you must annually write to the following or contact your OSHA Regional Office.

Technical Data Center
Frances Perkins Department Of Labor Building
Room N2439
200 Constitution Avenue
Washington, DC 20210

Copies of the standards can also be found on the Internet at: www.osha.gov.

These are not all inclusive of the applicable codes, standards, or regulations. It is your responsibility and your employer's responsibility to identify and comply with applicable codes, standards, and regulations.

The information provided herein is accurate as of the date your TEREX TELELECT unit was manufactured. You must comply with the codes, standards, and regulations as they are updated over time. It is your employer's responsibility to obtain copies and comply with all tests referenced.



OSHA EXCERPTS: (CLEARANCE DISTANCE)

The following are excerpts from OSHA Standards. They are not complete and do not cover all safety work rules.

Partial excerpt from Subpart S - Electrical: (02-01-1998 Edition)

1910.333 Selection and use of work practices.

(c), (i) Unqualified person.

(A) When an unqualified person is working in an elevated position near overhead lines, the location shall be such that the person and the longest conductive object he or she may contact cannot come closer to any unguarded, energized overhead line than the following distances:

1. For voltages to ground 50kV or below - 10 feet (305 cm);
2. For voltages to ground over 50kV - 10 feet (305 cm) plus 4 inches (10cm) for every 10kV over 50kV.

(B) When an unqualified person is working on the ground in the vicinity of overhead lines, the person may not bring any conductive object closer to unguarded, energized overhead lines than the distances given in paragraph (c)(3)(i)(A) of this section.

NOTE: For voltages normally encountered with overhead power line, objects which do not have an insulating rating for the voltage involved are considered to be conductive.

Excerpt from OSHA subpart V - Power Transmission and Distribution (11-14-1990 Edition)

1926.950 General Requirements (c) Clearances. The provisions of paragraph ©(1) or (2) of this section shall be observed.

(1) No employee shall be permitted to approach or take any conductive object without an approved insulating handle closer to exposed energized parts than shown in Table V-1, unless:

- (i) The employee is insulated or guarded from the energized part (gloves or gloves with sleeves rated for the voltage involved shall be considered insulation of the employee from the energized part), or
- (ii) The energized part is insulated or guarded from him and any other conductive object at different potential, or
- (iii) The employee is isolated, insulated, or guarded from any other conductive object(s), as during live-line bare-hand work.

(2) (i) The minimum working distance and minimum clear hot stick distances stated in Table V-1 shall not be violated. The minimum clear hot stick distance is that for the use of line-line tools held by lineman when performing live-line work.

(e)(15) The minimum clearance distances for live-line bare-hand work shall be as specified in Table V-2. These minimum clearance distances shall be maintained from all grounded objects and from lines and equipment at a different potential than that to which the insulated Aerial Device is bonded unless such grounded objects or other lines and equipment are covered by insulated guards. These distances shall be maintained when approaching, leaving, and when bonded to the energized circuit.

Table of Contents

Table V-1

Alternating Current Minimum Distances	
Voltage range (phase-to-phase) kilovolt	Minimum working and clear hot stick distances
2.1 to 15	2 ft. 0 in.
15.1 to 35	2 ft. 4 in.
35.1 to 46	2 ft. 6 in.
46.1 to 72.5	3 ft. 0 in.
72.6 to 121	3 ft. 4 in.
138 to 145	3 ft. 6 in.
161 to 169	3 ft. 8 in.
230 to 242	5 ft. 0 in.
345 to 362	¹ 7 ft. 0 in.
500 to 552	¹ 11 ft. 0 in.
700 to 765	¹ 15 ft. 0 in.

Table V-2













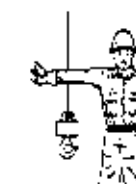

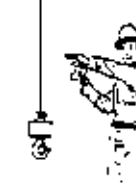

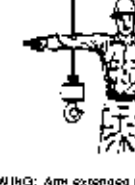

Minimum Clearance Distances For Live-Line Bare-Hand Work (Alternating Current)		
Voltage range (phase-to-phase) kilovolt	Distance in feet and inches for maximum voltage	
	Phase-to-ground	Phase to-phase
2.1 to 15	2 ft. 0 in.	2 ft. 0 in.
15.1 to 35	2 ft. 4 in.	2 ft. 4 in.
35.1 to 46	2 ft. 6 in.	2 ft. 6 in.
46.1 to 72.5	3 ft. 0 in.	3 ft. 0 in.
72.6 to 121	3 ft. 4 in.	4 ft. 6 in.
138 to 145	3 ft. 6 in.	5 ft. 0 in.
161 to 169	3 ft. 8 in.	5 ft. 6 in.
230 to 242	5 ft. 0 in.	8 ft. 4 in.
345 to 362	¹ 7 ft. 0 in.	¹ 13 ft. 4 in.
500 to 552	¹ 11 ft. 0 in.	¹ 20 ft. 0 in.
700 to 765	¹ 15 ft. 0 in.	¹ 31 ft. 0 in.

NOTE: Table V-1 - ¹For 345-362kv, 500-552kv, and 700-765kv, the minimum working distance and the minimum clear hot stick distance may be reduced provided that such distances are not less than the shortest distance between the energized part and a grounded surface.

NOTE: Table V-2 - ¹For 345-362kv, 500-552kv, and 700-765kv, the minimum clearance distance may be reduced provided the distances are not made less than the shortest distance between the energized part and a grounded surface.



STANDARD HAND SIGNALS

 <p>HOIST: With forearm vertical, forefinger pointing up, move hand in small horizontal circles.</p>	 <p>LOWER: With arm extended downward, forefinger pointing down, move hand in small horizontal circles.</p>	 <p>USE MAIN HOIST: Tap fist on head, then use regular signals.</p>	 <p>RAISE BOOM: Arm extended, fingers closed, thumb pointing upward.</p>	 <p>LOWER BOOM: Arm extended, fingers closed, thumb pointing downward.</p>
 <p>USE WHIP LIKE (Auxiliary Hoist): Tap elbow with one hand, then use regular signals.</p>	 <p>MOVE SLOWLY: use one hand to give any motion signal and place other hand motionless in front of hand giving the motion signal. (Hoist slowly shown as an example.)</p>	 <p>RAISE THE BOOM AND LOWER THE LOAD: With arm extended, thumb pointing up, flex fingers in and out as long as boom movement is desired.</p>	 <p>LOWER THE BOOM AND RAISE THE LOAD: With arm extended, thumb pointing down, flex fingers in and out as long as load movement is desired.</p>	 <p>DOG EVERYTHING: Clasp hands in front of body.</p>
 <p>SWING: Arm extended, palm with finger in direction of swing of boom.</p>	 <p>STOP: Arm extended, palm down, hold position rigidly.</p>	 <p>EMERGENCY STOP: Arm extended, palm down, move hand rapidly right and left.</p>	 <p>TRAVEL: Arm extended forward, hand open and slightly raised, make pushing motion in direction of travel.</p>	 <p>TRAVEL (One Track): Lock the track on side indicated by raised fist. Travel opposite track in direction indicated by circular motion of other fist, rotated vertically in front of body. (For lane cranes only.)</p>
 <p>TRAVEL (Both Tracks): use both fists in front of body, making a circular motion about each other, indicating direction of travel; forward or backward.</p>	 <p>RETRACT BOOM (Telescoping Boom): One hand Signal. One fist in front of chest, thumb pointing outward and heel of fist tapping chest.</p>	 <p>EXTEND BOOM (Telescoping Boom): Both fists in front of body with thumbs pointing outward.</p>	 <p>EXTEND BOOM (Telescoping Boom): One hand Signal. One fist in front of chest with thumb tapping chest.</p>	 <p>RETRACT BOOM (Telescoping Boom): Both fists in front of body with thumbs pointing toward each other.</p>

APPENDIX - B**ANSI A92.2-2001****ANSI A92.2-2001 (PARTIAL)****7. Responsibilities of Dealers and Installers**

7.1 General Responsibilities. Each dealer or installer as applicable shall comply with the requirements of this section.

7.2 Vehicle Specifications. Each dealer or installer, or both, who sells an Aerial Device shall inform the owner or user, or both, of the manufacturer's minimum vehicle specifications.

7.3 Vehicle Weight Distribution. The installer shall be responsible for the weight distribution of the completed mobile unit in accordance with the requirements of the Aerial Device and the applicable regulations. Allowance shall be made for the weight of readily removable tools and material specified by the user.

7.4 Manuals. Upon delivery of the equipment to the owner or user, the dealer or installer shall provide the manuals as required by Paragraph 6.4 of this standard and manuals for auxiliary equipment added by the installer.

7.5 Installations. The installer shall comply with Sections 5 and 6 of this standard relating to proper installation and shall follow the instructions of the manufacturer. In the event the original manufacturer no longer exists, an equivalent entity may provide these instructions. The installer of an Aerial Device shall, before the mobile unit is placed in operation, perform stability tests in accordance with the requirements of 4.5.1 and 4.5.2, the operational and visual tests in accordance with the requirements of 6.6.1 and 6.6.2, and the appropriate electrical tests required in 5.4.3 of this standard. The installer shall, when installing an Aerial Device on a chassis which is a highway vehicle, comply with all requirements of the applicable Federal Motor Vehicle Safety Standards in effect at the time of installation. Certification as a manufacturer (alteration, intermediate or final) of a motor vehicle under the Federal Motor Vehicle Safety Standards is required. The travel height of the mobile unit shall be posted in a location that is readily visible to the vehicle operator. For insulated Aerial Devices, the installer shall assure conformance to the Qualification test requirements of 5.3.2 by either obtaining certification of the test and performing a periodic test after installation, or by performing the Qualification test.

7.6 Quality Assurance. The installer shall have a documented quality assurance program which will ensure compliance with this standard.

7.7 Welding. All welds made by the installer, whose failure could result in motion of the platform(s) shall meet the Structural Welding Code AWS D1.1-98 and AWS D1.2-98. The installer shall establish applicable welding quality assurance procedures for all weldments.

7.8 Training. The dealer or installer shall offer training or training materials that aid owners and users in the operation, inspection, testing and maintenance of the Aerial Device. This training shall be offered initially and subsequently on request.

7.8.1 Dealer or Installer as User. Whenever a dealer or installer directs personnel to operate an Aerial Device (inspecting, sales demonstrations, or any form of use), the dealer or installer shall assume the responsibilities of users as specified in Section 9 of this standard. All personnel authorized to operate the Aerial Device shall have been trained.

8. Responsibilities of Owners

8.1 General Responsibilities. Each owner shall comply with the requirements of this section. The following responsibilities pertain to the owner's inspection, testing, maintenance, modification, training, and transfer of ownership. These activities shall be performed by qualified person(s).

8.2 Inspection and Testing Classifications.

8.2.1 Initial Inspection and Test. Prior to initial use, all new or modified mobile units shall be inspected and tested to ensure compliance with the provisions of this standard. Verification by the manufacturer, the installer or an equivalent entity(s), meets this requirement.



8.2.2 Regular Inspection and Tests. The inspection procedure for mobile units is divided into two classifications based upon the intervals at which inspections and tests shall be performed. Intervals shall be set by the owner in accordance with the manufacturer's recommendations. Such intervals are dependent upon component function and exposure to wear, deterioration and other agents which adversely affect component life. Two classifications are designated:

- (1) Frequent Inspection and Test: Daily to monthly intervals.
- (2) Periodic Inspection and Test: One to twelve month intervals.

8.2.3 Frequent Inspection and Test. Items determined by the owner in accordance with the manufacturer's recommendations for each specific Aerial Device shall be inspected for defects. The following tests and inspections shall be performed by the operator once daily, prior to first use:

- (1) Operating controls and associated mechanisms for conditions interfering with proper operation.
- (2) Visual and audible safety devices for malfunction.
- (3) Hydraulic or pneumatic systems for observable deterioration or excessive leakage.
- (4) Fiberglass and other insulating components for visible damage or contamination.
- (5) Missing or illegible operational and instructional markings.
- (6) Electrical systems of/or related to the Aerial Device for malfunction, signs of excessive deterioration, dirt and moisture accumulation.
- (7) Visual inspection of bolts, pins, and other fasteners for loose, deformed or missing fasteners and other locking devices.

Any suspected items shall be carefully examined or tested and a determination made by a qualified person as to whether they constitute a safety hazard.

All unsafe items shall be replaced or repaired before use.

8.2.4 Periodic Inspection or Test. An inspection of the mobile unit shall be performed at the intervals defined in 8.2.2 depending upon its activity, severity of service, and environment, or as specifically indicated below. (These inspections shall include the requirements of 8.2.3):

- (1) Structural members for deformation, cracks or corrosion.
- (2) Parts, such as pins, bearings, shafts, gears, rollers, locking devices, chains, chain sprockets, wire and synthetic ropes, and sheaves for wear, cracks or distortion.
- (3) Hydraulic and pneumatic relief valve settings.
- (4) Hydraulic system for proper oil level.
- (5) Hydraulic and pneumatic fittings, hoses, and tubing for evidence of leakage, abnormal deformation or excessive abrasion.
- (6) Compressors, pumps, motors, and generators for loose fasteners, leaks, unusual noises or vibrations, loss of operating speed, and excessive heating.
- (7) Hydraulic and pneumatic valves for malfunction and visible cracks in the external valve housing, leaks, and sticking spools.
- (8) Visually inspect any vacuum prevention systems and verify function of such systems on Category "A" Aerial Devices.
- (9) Hydraulic and pneumatic cylinders and holding valves for malfunction and visible damage.
- (10) Hydraulic and pneumatic filters for cleanliness and the presence of foreign material in the system indicating other component deterioration.
- (11) Electrical systems and components for deterioration or wear including those not readily visible on a frequent inspection.
- (12) Performance test of all boom movements.
- (13) Condition and tightness of bolts and other fasteners.
- (14) Welds, as specified by the manufacturer.

Appendix B

Table of Contents

(15) Legible and proper identification, operational, and instructional markings.

(16) If the Aerial Device is rated as an insulated device, the electrical insulating components and system(s) shall be thoroughly inspected for lack of cleanliness and other conditions that compromise insulation. Then these components and system(s) shall be tested for compliance with the rating of the Aerial Device in accordance with one of the applicable methods and procedures as outlined in section 5.4.3 of this standard:

(a) If the Aerial Device is used for AC bare-hand work, the unit shall undergo a 60 Hz test as shown in Table 2 at least every three years; (b) If the Aerial Device is used for DC bare-hand work, the unit shall undergo a DC test as shown in Table 2 at least every three years; (c) After repair or modification of any component that crosses the insulating system(s), or the repair or replacement of an insulating component(s), the unit shall be dielectrically tested in accordance with section 5.4.3; (d) An insulated replacement boom shall be tested to insure conformance to 5.3.3 by the supplier; (e) Bare-hand work units shall be tested as shown in Table I after any major repair to the insulated boom or any insulated boom replacement.

Any suspected items shall be carefully examined or tested and a determination made by a qualified person as to whether they constitute a safety hazard. All unsafe items shall be replaced or repaired before use.

8.3 Inspection and Test Records.

(1) Items to be inspected shall be designated to the operator or other authorized person making frequent inspections. Records of frequent inspections need not be made. However, where a safety hazard is found, it shall be reported in writing to a person responsible for the corrective action and that report and a record of the correction shall be maintained for five years, or as required by applicable regulations.

(2) Written, dated and signed reports and records shall be made of periodic inspections and tests and retained for a period of five years or as required by applicable regulations.

8.4 Maintenance. Maintenance and frequency of maintenance shall be determined by the owner in accordance with the manufacturer's recommendations.

Welding repairs of components or welds, designated as critical in the manufacturers manual, shall be made in accordance with the manufacturers recommendations.

Should the original manufacturer no longer exist an equivalent entity may determine the required procedure.

8.4.1 Maintenance Training. The owner shall train their maintenance personnel in inspection and maintenance of the Aerial Device in accordance with the manufacturer's recommendations and Section 8 of this standard.

8.5 Modifications. No modifications or additions which affect the stability, mechanical, hydraulic, or electrical integrity or the safe operation of the Aerial Device shall be made without the written approval of the manufacturer. If such modifications or changes are made, the capacity, operation, and maintenance instruction markings shall be changed accordingly. In no case shall the safety factors be reduced below those specified in this standard or below the manufacturers design safety factors, whichever are greater.

Should the original manufacturer no longer exist, an equivalent entity may approve required modification.

8.6 Weight Distribution. Changes in loading or additions made to the mobile unit after the final acceptance that affect weight distribution shall meet applicable regulations by governmental agencies. In no case shall axle loads of the fully loaded vehicle exceed the Gross Axle Weight Ratings (GAWR) assigned by the manufacturer. Note: Any change in weight distribution may adversely affect stability.

8.7 Transfer of Ownership. When a change in ownership of an Aerial Device occurs, it shall be the responsibility of the seller to provide the manufacturer's manual(s) for that Aerial Device to the purchaser.

It is the responsibility of the purchaser to notify the manufacturer of the unit model and serial number and the name and address of the new owner within 60 days.

8.8 Markings. The markings on the Aerial Device shall not be removed, defaced, or altered. All missing or illegible markings shall be promptly replaced.

8.9 Parts. When parts or components are replaced they shall be identical in specification and function to the original Aerial Device parts or components or shall provide an equal or greater factor of safety.

8.10 Safety Bulletins. Owners shall comply with safety related bulletins as received from the manufacturer, dealer or installer.

8.11 Manuals. The owner shall insure that the operating manual(s) is stored on the mobile unit.

8.12 Training, Retraining, and Familiarization of Operators.



8.12.1 Owner as a Renter or Lessor. When an owner functions as a renter or lessor he shall have the same responsibilities as specified under Section 11 of this standard.

8.12.2 General Training. Only personnel who have received general instructions regarding the inspection, application and operation of Aerial Devices, including recognition and avoidance of hazards associated with their operation, shall operate an Aerial Device. Such items covered shall include, but not necessarily be limited to, the following issues and requirements:

- (1) The purpose and use of manuals.
- (2) That operating manuals are an integral part of the Aerial Device and must be properly stored on the vehicle when not in use.
- (3) A pre-start inspection.
- (4) Responsibilities associated with problems or malfunctions affecting the operation of the Aerial Device.
- (5) Factors affecting stability.
- (6) The purpose of placards and decals.
- (7) Workplace inspection.
- (8) Applicable safety rules and regulations, such as Part 4, ANSI C2-1997, National Electrical Safety Code (applies to utility workers as defined in ANSI C2). The above standard is an example; other industries using Aerial Devices have safety rules pertinent to that industry.
- (9) Authorization to operate.
- (10) Operator warnings and instructions.
- (11) Actual operation of the Aerial Device.

Under the direction of a qualified person, the trainee shall operate the Aerial Device for a sufficient period of time to demonstrate proficiency in the actual operation of the Aerial Device.

- (12) Proper use of personal fall protection equipment

8.12.3 Retraining. The operator shall be retrained, when so directed by the user, based on the user's observation and evaluation of the operator.

8.12.4 Familiarization. When an operator is directed to operate an Aerial Device he/she is not familiar with, the operator, prior to operating, shall be instructed regarding the following items and issues:

- (1) The location of the manuals.
- (2) The purpose and function of all controls.
- (3) Safety devices and operating characteristics specific to the Aerial Device.

9. Responsibility of Users.

9.1 General Responsibilities. Each User shall comply with the requirements of this section.

9.2 Personnel. Only trained and authorized personnel shall be permitted to operate the Aerial Device.

9.3 Training, Retraining, and Familiarization of Operators.

9.3.1 General Training. Only personnel who have received general instructions regarding the inspection, application and operation of Aerial Devices, including recognition and avoidance of hazards associated with their operation, shall operate an Aerial Device. Such items covered shall include, but not necessarily be limited to, the following issues and requirements:

- (1) The purpose and use of manuals.
- (2) That operating manuals are an integral part of the Aerial Device and must be properly stored on the vehicle when not in use.
- (3) A pre-start inspection.
- (4) Responsibilities associated with problems or malfunctions affecting the operation of the Aerial Device.
- (5) Factors affecting stability.
- (6) The purpose of placards and decals.

Appendix B

Table of Contents

(7) Workplace inspection.

(8) Applicable safety rules and regulations, such as Part 4, ANSI C2-1997, National Electrical Safety Code. (applies to utility workers as defined in ANSI C2). The above standard is an example; other industries using Aerial Devices have safety rules pertinent to that industry.

(9) Authorization to operate.

(10) Operator warnings and instructions.

(11) Actual operation of the Aerial Device.

Under the direction of a qualified person, the trainee shall operate the Aerial Device for a sufficient period of time to demonstrate proficiency in the actual operation of the Aerial Device.

(12) Proper use of personal fall protection equipment.

9.3.2 Retraining. The operator shall be retrained, when so directed by the user, based on the user's observation and evaluation of the operator.

9.3.3 Familiarization. When an operator is directed to operate an Aerial Device he/she is not familiar with, the operator, prior to operating, shall be instructed regarding the following items and issues:

(1) The location of the manuals.

(2) The purpose and function of all controls.

(3) Safety devices and operating characteristics specific to the Aerial Device.

9.4 Application. The employer and assigned operator shall insure that the Aerial Device is used only for intended applications as defined in the operating manual, and that recognized safety practices are observed.

9.5 Mobile Operation. Before and during driving, the driver shall:

(1) Avoid traveling on any surface that adversely affects vehicle stability.

(2) Maintain a safe distance from obstacles and over-head lines.

(3) Maintain communications between the driver and the operator.

(4) Under all travel conditions, the driver shall limit travel speed in accordance with conditions of the ground surface, congestion, and slope.

9.6 Alterations. Altering or disabling of safety devices, guards, or interlocks if so equipped shall be prohibited.

9.7 Bare-Hand Work. For bare-hand work, a Category "A" Aerial Device shall be used.

9.8 Lower Controls. The lower controls of Aerial Devices shall not be used for continuous operation with personnel in the platform.

10. Responsibilities of Operators

10.1 General Responsibilities. Each operator shall comply with the requirements of this section.

10.2 Operation. During operation of the Aerial Device all platform occupants shall use appropriate fall protection connected to the Aerial Device at the platform position.

10.3 Work Platform. The operator shall not use railings, planks, ladders or any other device in or on the work platform for achieving additional working height or reach.

10.4 Brakes. The vehicle parking brake(s) shall be set at all times that the boom is elevated except when the Aerial Device is being used in accordance with 9.5.

10.5 Loading. Any loading which includes a horizontal load shall be avoided unless the mobile unit is designed for that application.

10.6 Observations. Observations during operation for any defects shall be conducted on an ongoing basis.

10.6.1 Pre-start Inspection. Items determined by the owner in accordance with the manufacturer's recommendations for each specific Aerial Device shall be inspected for defects prior to each day's operation.



Table of Contents

The following tests and inspections shall be performed by the operator once daily, prior to first use:

- (1) Operating controls and associated mechanisms for conditions interfering with proper operation.
- (2) Visual and audible safety devices for malfunction.
- (3) Hydraulic or pneumatic systems for observable deterioration or excessive leakage.
- (4) Fiberglass and other insulating components for visible damage or contamination.
- (5) Missing or illegible operational and instructional markings.
- (6) Electrical systems of/or related to the Aerial Device for malfunction, signs of excessive deterioration, dirt and moisture accumulation.
- (7) Visual inspection of bolts, pins, and other any other fasteners for loose, deformed or missing fasteners and other locking devices.

Any suspected items shall be carefully examined or tested and a determination made by a qualified person as to whether they constitute a safety hazard. All unsafe items shall be replaced or repaired before use.

10.7 Worksite. Before the Aerial Device is used the worksite shall be surveyed for hazards such as:

- (1) Untamped earth fills.
- (2) Ditches.
- (3) Drop-offs and floor obstructions.
- (4) Debris.
- (5) Overhead obstructions and electrical conductors.
- (6) Weather conditions.
- (7) Presence of unauthorized persons.

10.8 Precautions. Before and during each use the operator shall:

- (1) Check for overhead obstructions and electrical conductors.
- (2) Insure that the load on the platform and/or load lifting devices are in accordance with the manufacturer's rated capacity.
- (3) Insure that outriggers and stabilizers are used if the manufacturer's instructions require their use.
- (4) Insure that guardrails are properly installed, and the gates are closed.
- (5) Use outrigger pads when necessary to provide firm footing.

10.9 Mobile Operation. Before engaging in mobile operation the operator shall determine that the Aerial Device is specifically designed for mobile operation.

10.10 Personnel. Only trained and authorized personnel shall be permitted to operate the Aerial Device.

10.11 Training, Retraining, and Familiarization of Operators.

10.11.1 General Training. Only personnel who have received general instructions regarding the inspection, application and operation of Aerial Devices, including recognition and avoidance of hazards associated with their operation, shall operate an Aerial Device. Such items covered shall include, but not necessarily be limited to, the following issues and requirements:

- (1) The purpose and use of manuals.
- (2) That operating manuals are an integral part of the Aerial Device and must be properly stored on the vehicle when not in use.
- (3) A pre-start inspection.
- (4) Responsibilities associated with problems or malfunctions affecting the operation of the Aerial Device.
- (5) Factors affecting stability.
- (6) The purpose of placards and decals.
- (7) Workplace inspection.
- (8) Applicable safety rules and regulations, such as Part 4, ANSI C2-1997, National Electrical Safety Code

Appendix B

Table of Contents

(applies to utility workers as defined in ANSI C2). The above standard is an example; other industries using Aerial Devices have safety rules pertinent to that industry.

- (9) Authorization to operate.
- (10) Operator warnings and instructions.
- (11) Actual operation of the Aerial Device.

Under the direction of a qualified person, the trainee shall operate the Aerial Device for a sufficient period of time to demonstrate proficiency in the actual operation of the Aerial Device.

- (12) Proper use of personal fall protection equipment

10.11.2 Retraining. The operator shall be retrained, when so directed by the user, based on the user's observation and evaluation of the operator.

10.11.3 Familiarization. When an operator is directed to operate an Aerial Device he/she is not familiar with, the operator, prior to operating, shall be instructed regarding the following items and issues:

- (1) The location of the manuals.
- (2) The purpose and function of all controls.
- (3) Safety devices and operating characteristics specific to the Aerial Device.

11. Responsibilities of Renters, Lessors or Lessees

11.1 General Responsibilities. Each renter or lessor or lessee shall comply with the requirements of the applicable section or sections below.

11.1.1 Lessor or Lessee as Dealer or Installer. When a lessor or lessee uses the Aerial Device as a dealer or installer he shall have the same responsibilities as specified under Section 7 of this standard.

11.1.2 Lessor or Lessee as Owner. When a lessor or lessee uses the Aerial Device as an owner he shall have the same responsibilities as specified under Section 8 of this standard.

11.1.3 Lessor or Lessee as User. When a lessor or lessee uses the Aerial Device as a user he shall have the same responsibilities as specified under Section 9 of this standard.

11.1.4 Lessor or Lessee as Operator. When a lessor or lessee uses the Aerial Device as an operator he shall have the same responsibilities as specified under Section 10 of this standard.

11.2 Ownership Duties. The renter or lessor shall carry out the duties of ownership specified in this standard which are not assigned to the renting entity or lessee as the user.

11.3 Obligations. Upon delivery each renter or lessor of an Aerial Device shall provide the operators manual and the ANSI/SIA A92.2-xxxxManual of Responsibilities for dealers, owners, users, operators, lessors and lessees of Vehicle Mounted Elevating and Rotating Aerial Devices. These manuals shall be stored on the mobile unit.

11.4 Training. The renter or lessor shall offer training or training materials that aid the renting entity or lessee in the operation, inspection, testing and maintenance of the Aerial Device. This training shall be offered initially and subsequently on request.

11.4.1 General training. Only personnel who have received general instructions regarding the inspection, application and operation of Aerial Devices, including recognition and avoidance of hazards associated with their operation, shall operate an Aerial Device. Such items covered shall include, but not necessarily be limited to, the following issues and requirements:

- (1) The purpose and use of manuals.
- (2) That operating manuals are an integral part of the Aerial Device and must be properly stored on the vehicle when not in use.
- (3) A pre-start inspection.
- (4) Responsibilities associated with problems or malfunctions affecting the operation of the Aerial Device.
- (5) Factors affecting stability.
- (6) The purpose of placards and decals.



(7) Workplace inspection.

(8) Applicable safety rules and regulations, such as Part 4, ANSI C2-1997, National Electrical Safety Code (applies to utility workers as defined in ANSI C2). The above standard is an example; other industries using Aerial Devices have safety rules pertinent to that industry.

(9) Authorization to operate.

(10) Operator warnings and instructions.

(11) Actual operation of the Aerial Device.

Under the direction of a qualified person, the trainee shall operate the Aerial Device for a sufficient period of time to demonstrate proficiency in the actual operation of the Aerial Device.

(12) Proper use of personal fall protection equipment

11.4.2 Familiarization. When an operator is directed to operate an Aerial Device he/she is not familiar with, the operator, prior to operating, shall be instructed regarding the following items and issues:

(1) The location of the manuals.

(2) The purpose and function of all controls.

(3) Safety devices and operating characteristics specific to the Aerial Device.

11.5 Communications. In the event the manufacturer or installer provides the renter or lessor manuals, bulletins, or other materials for the information of the user of an Aerial Device, the renter or lessor shall pass them on to the user without any undue delay.